

SIEMENS

Ingenuity for life

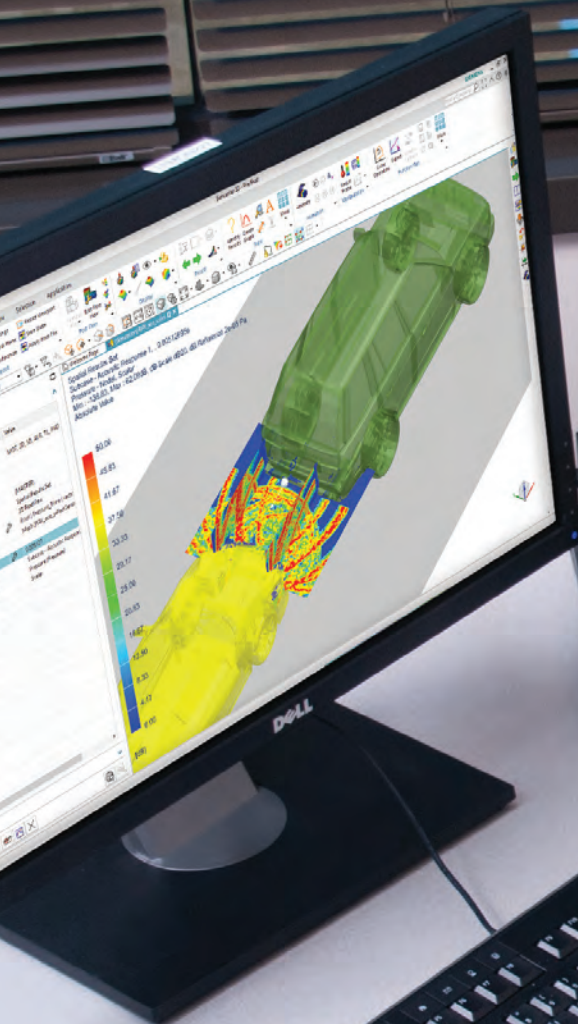

Siemens Digital Industries Software

Simcenter 3D

Solution guide

[siemens.com/simcenter3d](https://www.siemens.com/simcenter3d)

SIEMENS

Ingenuity for life

Simcenter 3D

Introduction

Siemens Digital Industries Software

Addressing complex engineering challenges by enhancing simulation efficiency

Computer-aided engineering (CAE) has long proven its value as a troubleshooting and analysis tool, but is generally perceived as slow, delivering accurate results too late to drive development. The simulation process with traditional CAE tools is slow due to tedious geometry cleanup processes, and simulation disciplines are disconnected from each other, hampering efficient workflows.

To meet complex challenges, product engineering teams need a unified, shared platform for all simulation disciplines, with leading-edge analysis tools that are easy-to-use, incorporate more productive workflows and produce consistent results.

Welcome to Simcenter 3D

Simcenter™ 3D software from Siemens Digital Industries Software addresses complex product engineering processes by delivering revolutionary improvements in simulation efficiency. With advanced capability 3D simulation technologies and a comprehensive range of CAE applications, Simcenter 3D offers new methods that increase realism and deliver better insight into your product's performance. Simcenter 3D captures expert knowledge and best-practice workflows, enabling engineers and analysts to collaborate on a platform that accommodates all aspects of functional performance.

Faster CAE processes

Simcenter 3D is an integrated environment in which you do all of your CAE pre- and postprocessing. Within this environment, Simcenter 3D offers what customers often describe as unrivaled geometry manipulation tools that can

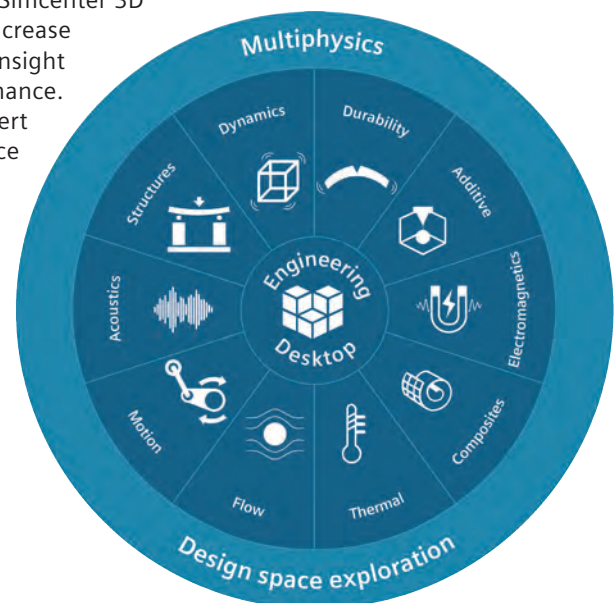

handle computer-aided design (CAD) data from any source, provide comprehensive meshing and modeling for multiple simulation applications, and deliver the unique capability to associate the analysis model to design data. This helps you speed the tedious modeling process and keep analysis models in sync with the latest design. This translates into a much faster CAE process than can be achieved with traditional CAE tools.

Multidiscipline integration

Simcenter 3D integrates industry-standard, multidiscipline simulation solvers, all from a centralized engineering environment. The Simcenter 3D simulation solvers for structures, acoustics, structural dynamics, durability, motion, thermal, flow, electromagnetics and more help you to predict real-world performance for a large variety of physics domains. This tight integration of solutions streamlines multiphysics processes that would otherwise be too challenging to perform.

Open and scalable

In addition to supporting Siemens' multidiscipline solvers, Simcenter 3D can be used as a pre- and postprocess-

ing tool for other common, third-party solvers like ANSYS, Abaqus, MSC Nastran and LS-Dyna. This means you can take advantage of the excellent CAD associativity, geometry editing tools and comprehensive meshing capabilities of Simcenter 3D to immediately reduce the time necessary for your simulation workflows. The common environment also gives engineers a scalable platform on which to build automated routines to drive repeatable and complex simulation processes.

Tied into the digital thread

As part of the Simcenter portfolio of simulation tools, Simcenter 3D integrates with the digital thread that spans 3D simulation, 1D simulation and testing solutions. However, simulation is just a part of a longer digital thread running through your product development processes. Simcenter 3D also keeps your simulation processes tied to this longer thread with a seamlessly managed environment that connects with simulation data management. This keeps your simulation processes in sync with digital development processes like CAD, routing, product requirements and manufacturing processes.

Flexible licensing

To make Simcenter 3D even more flexible for your simulation team, Simcenter 3D offers value-based token licensing. Instead of purchasing individual licenses for each add-on module, you can buy packs of tokens that allow you to instantly access most Simcenter 3D products. With value-based licensing, almost the entire suite of Simcenter 3D products is immediately available to you and your team.

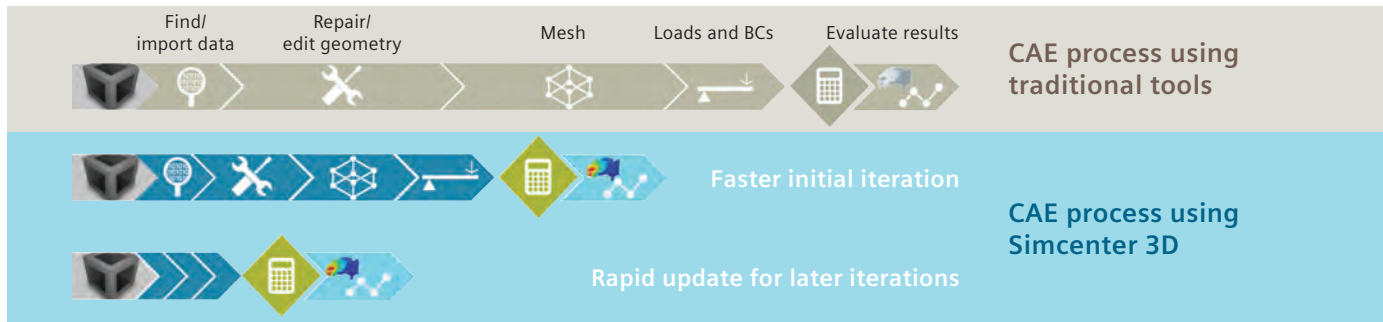

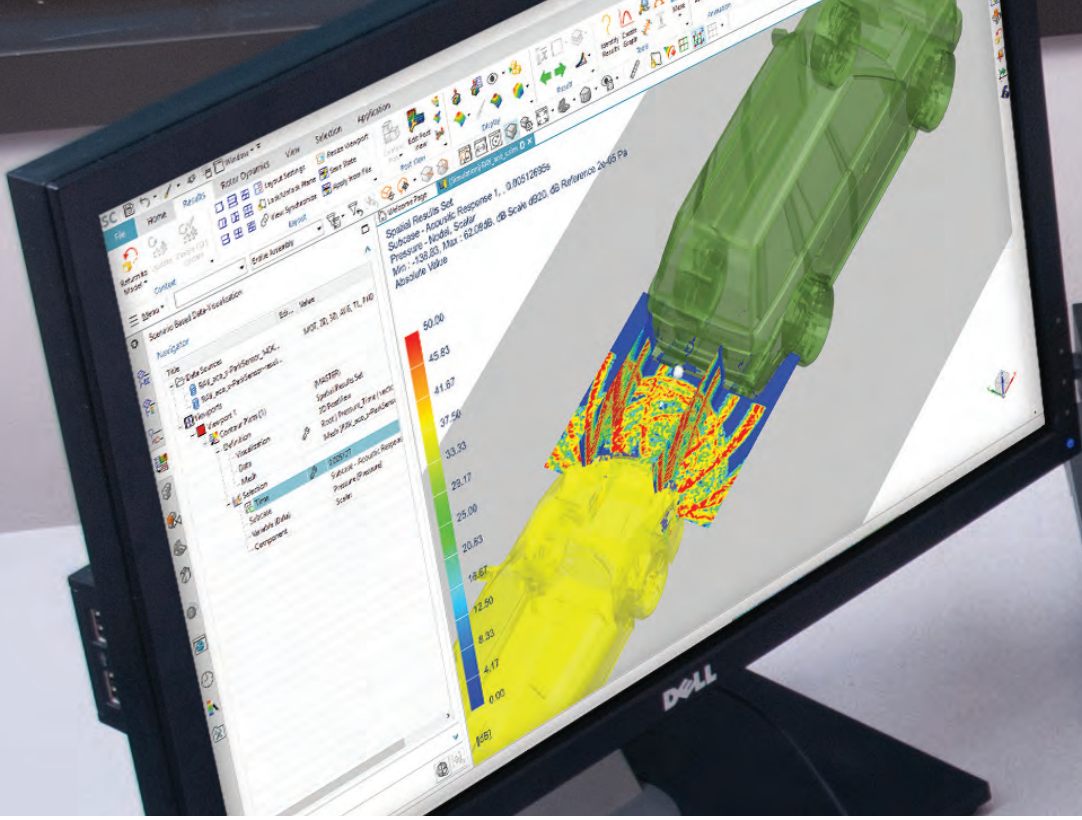



Simcenter 3D is the most comprehensive, fully-integrated CAE solution on the market today, and this solution guide will help you understand what it has to offer for engineering simulation. This guide starts with the foundation, Simcenter 3D Engineering Desktop, which is the central platform and user interface you use to model, perform and evaluate all of your simulations. The rest of the sections outline the physics domains you can work in and the kind of solutions you can perform with Simcenter 3D.

Welcome to the world of Simcenter 3D!

Table of contents

Engineering Desktop	6 – 19
Structures	20 – 29
Structural dynamics	30 – 47
Durability	48 – 59
Acoustics	60 – 75
Motion	76 – 101
Multiphysics	102 – 113
Thermal	114 – 125
Flow	126 – 135
Electromagnetics	136 – 147
Optimization	148 – 157
Additive manufacturing	158 – 165
Aerostructures	166 – 173
Composites	174 – 183
Simulation data management	184 – 190
Appendix	191

SIEMENS

Ingenuity for life

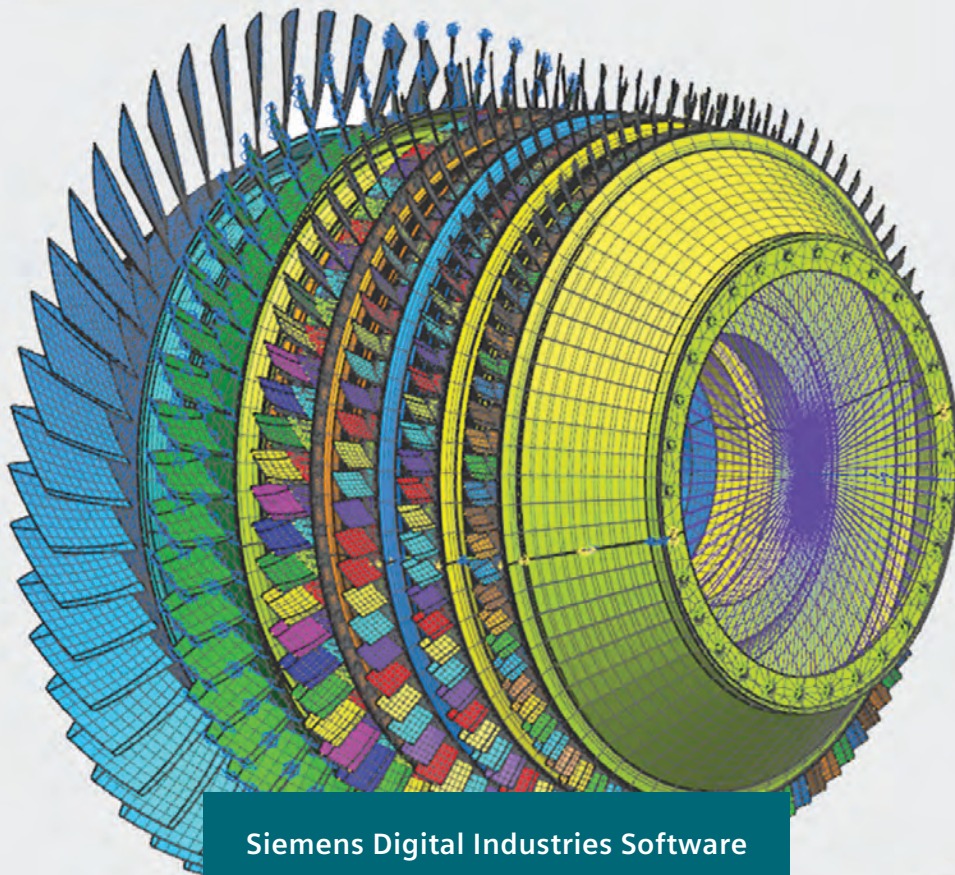

Siemens Digital Industries Software

Simcenter 3D Engineering Desktop

Integrating geometry and FE modeling
to streamline product development

[siemens.com/simcenter3d](https://www.siemens.com/simcenter3d)



Solution benefits

- Provide a platform for multidiscipline simulation
- Enable fast, intuitive geometry editing
- Deliver comprehensive meshing
- Efficiently create and manage finite element assemblies
- Quickly pre- and postprocess finite element models for popular common finite element solvers
- Capture knowledge and automate processes

Simcenter™ 3D Engineering Desktop software is a unified, open and extensible computer-aided engineering (CAE) environment for advanced analysts. Simcenter 3D Engineering Desktop is the hub of the Simcenter 3D platform, and it speeds the simulation process by helping you to efficiently build the model you need from 3D geometry faster than traditional CAE preprocessors.

Providing a platform for multidiscipline simulation

Simcenter 3D Engineering Desktop sits at the core of a broader, integrated multidiscipline simulation environment. Simcenter 3D Engineering Desktop is the centralized working environment for pre-/postprocessing of all Simcenter 3D solutions for structural, dynamics, composites, durability,

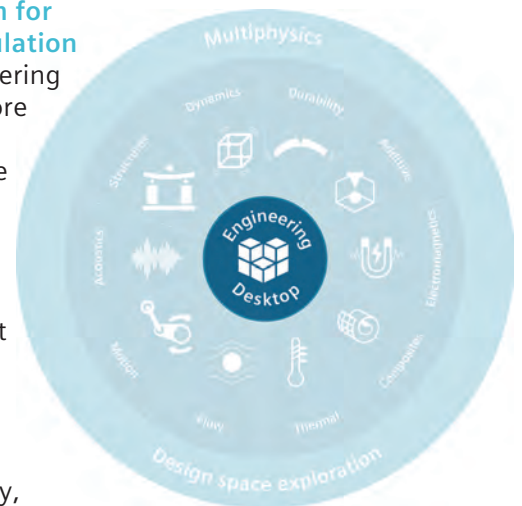

Simcenter 3D Engineering Desktop

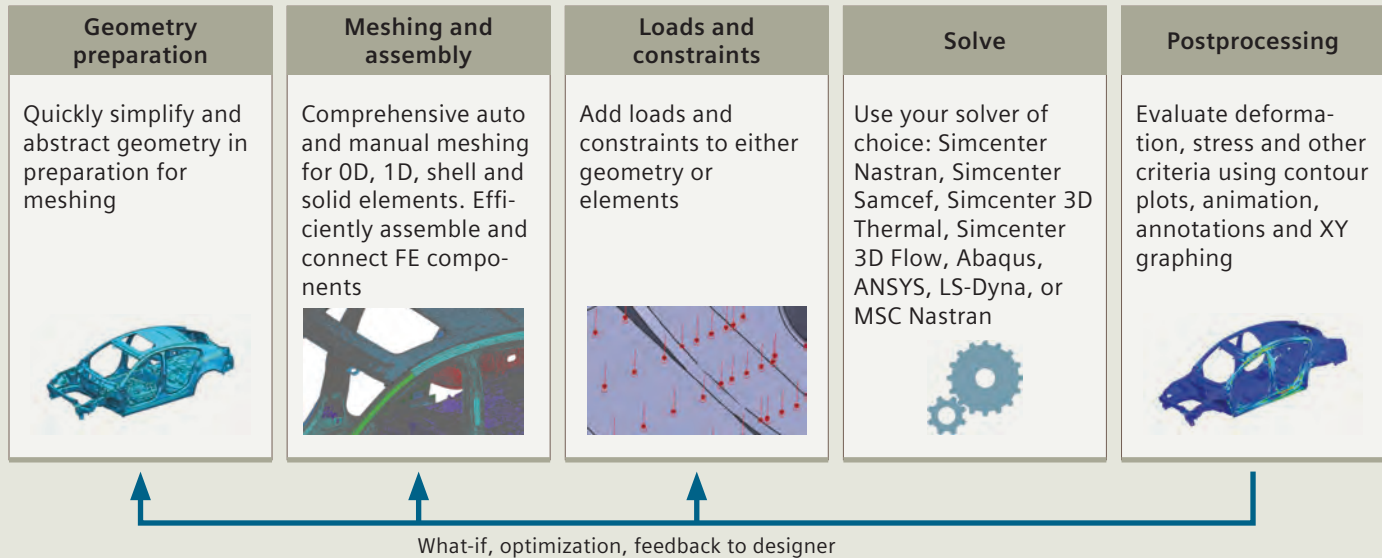

acoustics, thermal, flow, motion, optimization, and electromagnetics. This integrated environment helps you to achieve faster CAE processes and streamline multidiscipline simulations that integrate any of the Simcenter 3D solutions together, like thermal-mechanical, vibro-acoustic, or other more complex analyses.

Enabling fast, intuitive geometry editing

Simcenter 3D Engineering Desktop is built on an industry-leading geometry foundation. By using Simcenter 3D Engineering Desktop, you can rapidly clean up and prepare geometry from any computer-aided design (CAD) source using direct modeling. Geometry edits and the complete analysis model remain associated to the base design, which means you can easily update your analysis model each time the design changes. As a result, using Simcenter 3D Engineering Desktop accelerates your design-analysis iterations and improves your overall productivity.

Delivering comprehensive meshing

Simcenter 3D Engineering Desktop includes extensive modeling functions for automatic and manual mesh generation of OD, 1D, 2D and 3D elements, and numerous techniques for applying loads and boundary conditions. The Simcenter 3D Engineering Desktop integrated environment is unique because it associates the analysis model to its geometry so when the design geometry changes, it rapidly updates the existing analysis geometry, mesh, loads and boundary conditions. This approach greatly reduces downstream modeling

time, which results in huge time savings across a project's many design-analysis iterations.

Efficiently create and manage FE assemblies

Unlike traditional CAE preprocessors that were developed for component analysis and require you to build monolithic analysis models, the Simcenter 3D Engineering Desktop assembly finite element (FE) model (AFEM) management tool enables you to create large assembly models by instancing and connecting component models together, like a CAD assembly. When an FE component is updated later in development, Simcenter 3D Engineering Desktop updates all instances of that component in the assembly, eliminating the need to rebuild and connect a new FE assembly.

Supporting multiple common CAE solvers

Take advantage of Simcenter 3D pre- and postprocessing benefits with all your FE solvers. Simcenter 3D Engineering Desktop can be used as the primary pre- and postprocessor for Simcenter Nastran® software and Simcenter Samcef® software, or for third-party solvers such as Abaqus, ANSYS, LS-DYNA and MSC Nastran. This is accomplished with immersive user environments that use the selected solver's terminology, which enables analysts to easily prepare solver-specific analysis models without the need to learn new terminology.

Capturing knowledge and automating processes

Simcenter 3D Engineering Desktop allows engineering organizations to capture the expertise of senior analysts and make it available for others in the organization to use in the form of wizards and templates. CAE processes can be captured and automated using NX™ Open software, an open framework for automation and programming. Analysts can capture the steps of a CAE process and then develop scripts and easy-to-use dialog boxes so others can re-use the same process. Since Simcenter 3D Engineering Desktop is built on top of the same platform as NX CAD, designers who use NX can continue to work in a familiar environment when they perform CAE.

Seamlessly connect with simulation data management

Simcenter 3D Engineering Desktop seamlessly integrates with the entire Teamcenter® software data management portfolio, including the simulation process management module. Simulation data management capabilities work out-of-the-box (OOTB), and companies can implement a complete environment for managing CAE data, processes and workflow as part of a wider product development environment. This reduces waste by promoting re-use of existing designs and engineering knowledge. It also synchronizes data and makes it readily accessible using data mining, visualization and reporting.

Industry applications

CAE is used across almost all industries today. However, the CAE process is still quite inefficient as engineers can spend upwards of 80 percent of their time on analysis modeling. Simcenter 3D Engineering

Desktop can help drastically reduce the time you spend on modeling these industry applications.

Aerospace and defense

Engineers that work on airframes and aircraft engines have vastly different needs for simulation modeling. Simcenter 3D can be used to efficiently handle the large assemblies that airframers need to manage, and it can also easily facilitate building the axisymmetric models that are required for aero engines.

Automotive and transportation

Body-in-white (BIW) modeling is a time-consuming process that requires a connection between hundreds of FE components. Simcenter 3D Engineering Desktop can help automate and reduce the time spent on BIW modeling.

Consumer products

The consumer goods market moves fast, which means your engineers need to move even faster. Simcenter 3D helps you keep pace with rapid design changes so you can quickly simulate the latest iteration of your design.

Industrial machinery

From structural components and rotating equipment to large complex machines, Simcenter 3D Engineering Desktop can help you quickly create the right analysis model.

Marine

Ship models can be quite large, and Simcenter 3D Engineering Desktop has FE assembly management tools that can help you create easy-to-manage structural models.

TEST-CAE correlation

Structures

- NVH and acoustics
- Thermal
- Flow
- Composites
- Additive manufacturing

Motion

- Rotor dynamics
- Electro-magnetics
- Durability
- Optimization

1D - 3D co-simulation

Multiphysics

Linear FEM

Nonlinear FEM

BEM

Multibody

Fatigue

Electronics cooling

CFD

Multiscale models

Simcenter 3D Engineering Desktop

Simcenter 3D Engineering Desktop is a unified, scalable, open and extensible 3D CAE environment for advanced analysts. It speeds the simulation process by helping you to efficiently build the simulation model you need from 3D geometry faster than traditional CAE preprocessors.

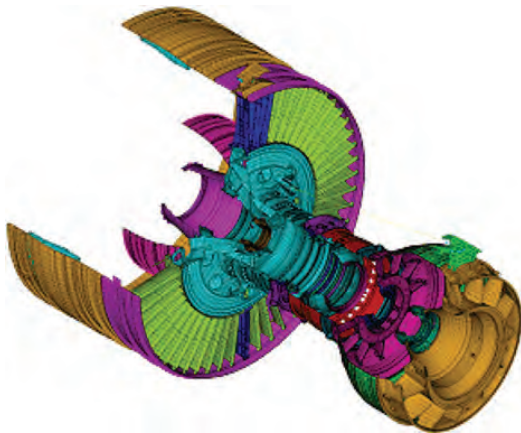
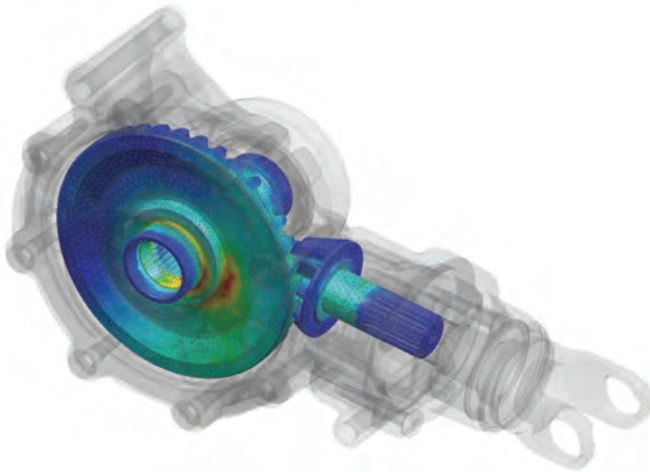

Module benefits

- Speed simulation processes by up to 70 percent
- Increase product quality by rapidly simulating design tradeoff studies
- Lower overall product development costs by reducing costly, late design change orders
- Efficiently manage large, complex FE assemblies
- Capture and automate best practices and commonly used processes
- Provide pre- and postprocess analysis models for the most popular finite element solvers
- Easily add multidiscipline simulation capabilities as your analysis needs grow

Key features

- An industry-leading geometry foundation for faster geometry editing and abstraction
- Comprehensive meshing tools
- Efficient FE assembly management
- Extensive graphics, plotting and reporting capabilities for postprocessing
- An open and extensible platform
- Seamless integration with simulation data management

Simcenter 3D Environment for Simcenter Nastran

Included with Simcenter 3D Engineering Desktop, the Simcenter 3D Environment for Simcenter Nastran® software enables you to build finite element models, define solution parameters and view the solution results for the Simcenter Nastran solver. The environment immerses you in familiar Simcenter Nastran language for element definitions, loads and boundary conditions, solution parameters and other common Simcenter Nastran nomenclature. In addition to defining model capabilities, the Simcenter Nastran environment provides bi-directional import/export capabilities that enable you to import current or legacy Simcenter Nastran bulk data files and results as well as export its run-ready data files.

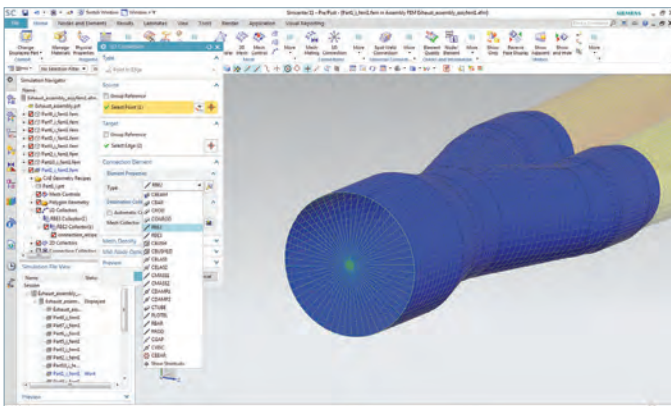

Module benefits

- Simplifies the Simcenter Nastran modeling process by enabling engineers to create analysis models based on geometry or legacy Simcenter Nastran input data files
- Reduces or eliminates intermediate manual processing of data files by generating run-ready decks directly from Simcenter 3D

Key features

- Immerses engineers in the Simcenter Nastran environment by using familiar terminology and extensive support of product-specific elements and entities
- The Simcenter Nastran environment supports a variety of solutions:
 - SOL 101 – Linear statics
 - SOL 103 – Normal modes
 - SOL 105 – Buckling
 - SOL 106 – Nonlinear and linear statics
 - SOL 107 – Direct complex eigenvalues
 - SOL 108 – Direct frequency response
 - SOL 109 – Direct transient response
 - SOL 110 – Modal complex eigenvalues
 - SOL 111 – Modal frequency response
 - SOL 112 – Modal transient response
 - SOL 129 – Nonlinear and linear transient response
 - SOL 153 – Static structural and/or steady-state heat transfer analysis with options: linear or nonlinear analysis
 - SOL 159 – Transient structural and/or transient heat transfer analysis with options: linear or nonlinear analysis
 - SOL 200 – Design optimization with option for only sensitivity analysis
 - SOL 401 – Multistep, structural solution that supports a combination of static (linear or nonlinear) subcases and modal (real eigenvalue) subcases
 - SOL 402 – Multistep, structural solution that supports a combination of subcase types (static linear, static nonlinear, nonlinear dynamic, preload, modal, Fourier, buckling) and supports large rotation kinematics
 - SOL 601/106 – Advanced nonlinear and linear statics
 - SOL 601/129 – Advanced nonlinear and linear transient response
 - SOL 701 – Explicit nonlinear

Simcenter 3D Environment for Simcenter Samcef

The Simcenter 3D Environment for Simcenter Samcef enables you to build FE models, define solution parameters and visualize results for the Simcenter Samcef solver. This environment allows you to take advantage of powerful geometry editing, meshing and general preprocessing capabilities in Simcenter 3D to build analysis models for the Simcenter Samcef faster than with traditional CAE tools.

Module benefits

- Simplifies the modeling process by enabling you to create analysis models based on geometry or legacy Simcenter Samcef input data files
- Reduces or eliminates intermediate manual processing of data files by generating run-ready decks directly from Simcenter 3D

Key features

- Immerses you in the Simcenter Samcef environment by using familiar terminology and providing extensive support for specific elements and entities of the product
- Includes a variety of supported analysis types:
 - Linear statics with several load cases
 - Modal analysis
 - Buckling analysis with several load cases
 - Nonlinear static and dynamic analysis with several subcases
 - Thermal analysis
 - Chaining of analysis

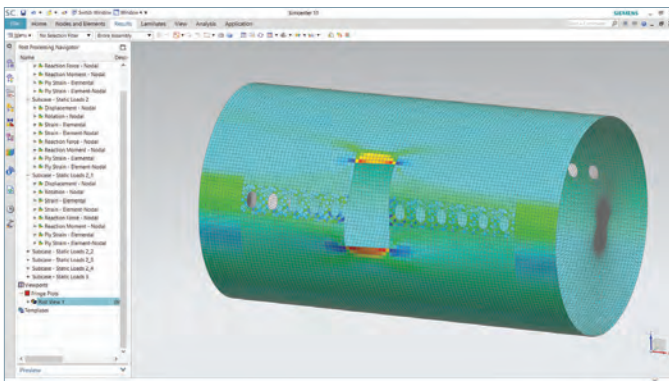

Simcenter 3D Environment for Abaqus

The Simcenter 3D Environment for Abaqus enables you to build finite element models, define solution parameters and view the solution results for the Abaqus solver. The environment immerses you in familiar Abaqus language for element definitions, loads and boundary conditions, solution parameters and other common Abaqus nomenclature. In addition to defining model capabilities, the Abaqus environment enables bi-directional import/export capabilities that enable you to import its current or legacy data files and results, as well as export run-ready Abaqus input data files.

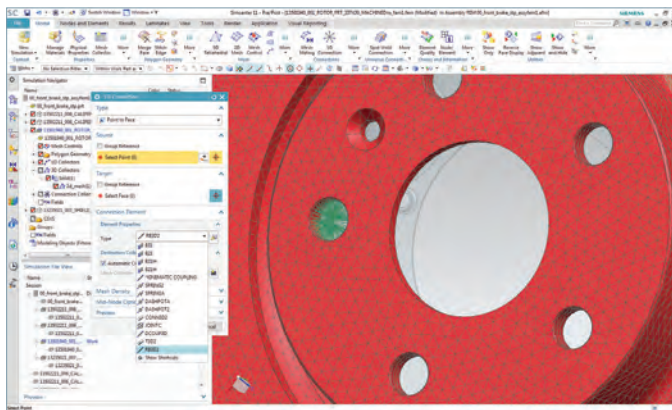

Module benefits

- Simplifies the Abaqus modeling process by enabling you to create analysis models based on geometry or legacy input data files
- Reduces or eliminates intermediate manual processing of data files by generating run-ready decks directly from Simcenter 3D

Key features

- Structural: statics, buckling and modal
- Steady-state heat transfer
- Visco analyses
- Transient modal dynamic analyses
- Response spectrum analysis
- Complex eigenvalue extraction analysis
- Implicit dynamic stress and displacement analyses
- Dynamic explicit analysis and axisymmetric dynamic explicit analysis
- Direct cyclic analyses

Simcenter 3D Environment for ANSYS

The Simcenter 3D Environment for ANSYS enables you to build finite element models, define solution parameters and view the solution results for the ANSYS solver. The environment immerses you in familiar ANSYS language for element definitions, loads and boundary conditions, solution parameters and other common nomenclature. In addition to defining model capabilities, the ANSYS environment provides bi-directional import/export capabilities that enable you to import its current or legacy data files and results, as well as export run-ready ANSYS input data files.



Module benefits

- Simplifies the ANSYS modeling process by enabling you to create analysis models based on geometry or legacy input data files
- Reduces or eliminates intermediate manual processing of data files by generating run-ready decks directly from Simcenter 3D

Key features

- Immerses you in the ANSYS environment by using familiar terminology and extensive support of specific elements and entities of ANSYS
- Supported solutions include:
 - Structural linear static, modal, buckling and nonlinear static
 - Cyclic symmetry analysis for linear static, modal, nonlinear static, or harmonic – mode superposition
 - Axisymmetric structural linear and nonlinear statics
 - Modal flexible body (for use in Simcenter 3D Motion analysis)
 - Nonlinear buckling
 - Transient dynamic
 - Harmonic
 - Thermal and axisymmetric thermal
 - Thermal transient
 - Thermal-structural multiphysics

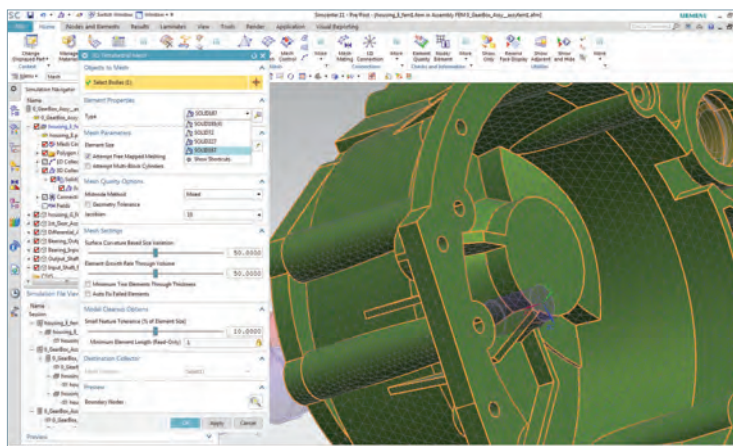
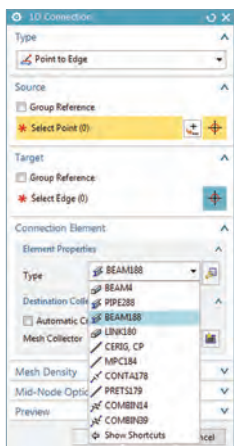

Simcenter 3D Environment for LS-Dyna

The Simcenter 3D Environment for LS-Dyna enables you to build finite element models and define solution parameters for the LS-Dyna solver. The environment immerses you in familiar LS-Dyna language for element definitions, loads and boundary conditions, solution parameters and other common LS-Dyna nomenclature. In addition to defining model capabilities, the LS-Dyna environment enables bi-directional import/export capabilities that allow you to import current or legacy data files and results, as well as export run-ready LS-Dyna input data files.

Module benefits

- Simplifies the LS-Dyna modeling process by enabling you to create analysis models based on geometry or legacy LS-Dyna input data files

Key features

- Immerses you in the LS-Dyna environment by using familiar terminology and supporting specific product elements and entities
- Supports general structural impact solution

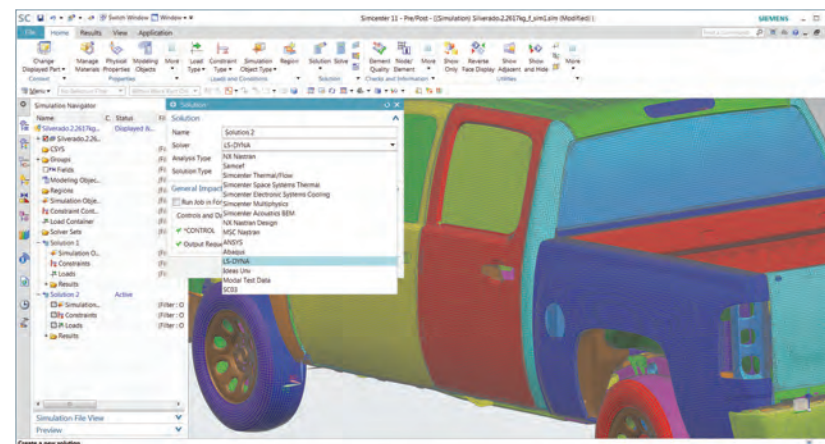
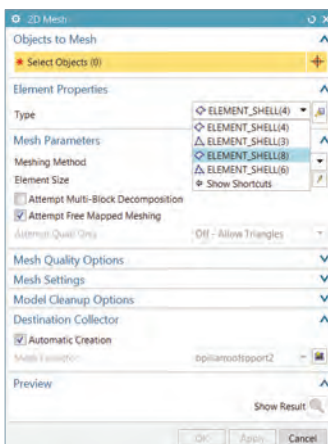

Simcenter 3D Environment for MSC Nastran

The Simcenter 3D Environment for MSC Nastran software enables you to build finite element models, define solution parameters and view the solution results for the MSC Nastran solver. The environment immerses you in familiar MSC Nastran language for element definitions, loads and boundary conditions, solution parameters and other common MSC Nastran nomenclature. In addition to model definition capabilities, the MSC Nastran environment provides bi-directional import/export capabilities that enable you to import current or legacy MSC Nastran bulk data files and results as well as export run-ready data files.

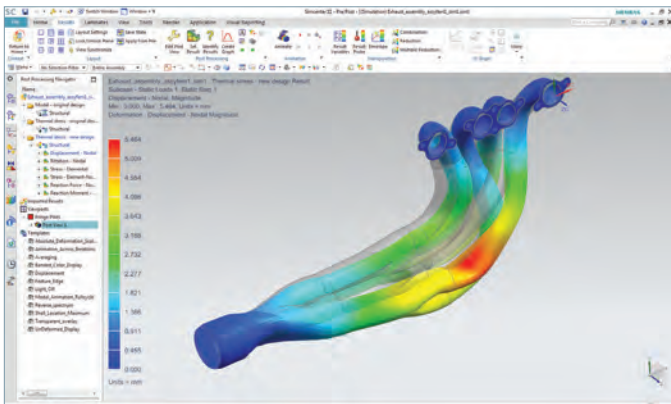
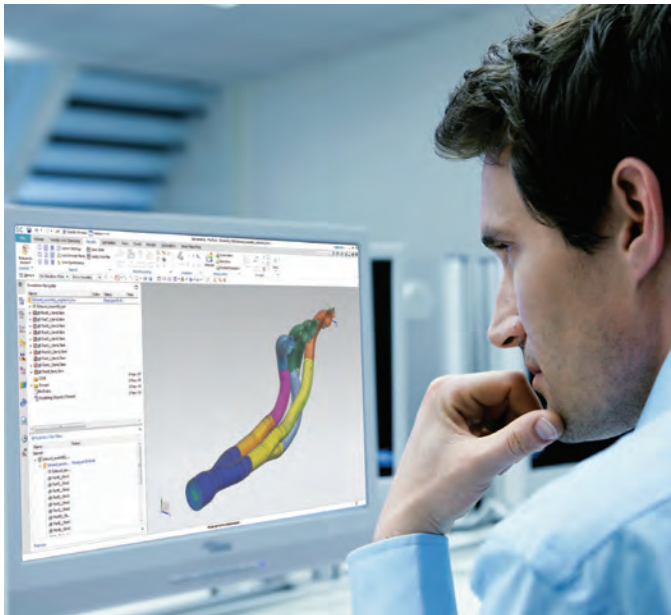

Module benefits

- Simplifies the MSC Nastran modeling process by enabling you to create analysis models based on geometry or legacy MSC Nastran input data files
- Reduces or eliminates intermediate manual processing of data files by generating run-ready decks directly from Simcenter 3D

Key features

- Immerses you in the MSC Nastran environment by using familiar MSC Nastran terminology and extensive support of product-specific elements and entities
- There are a variety of supported solutions:
 - SOL 101 – Linear statics
 - SOL 103 – Normal modes
 - SOL 105 – Buckling
 - SOL 106 – Nonlinear or linear statics
 - SOL 107 – Direct complex eigenvalues
 - SOL 108 – Direct frequency response
 - SOL 109 – Direct transient response
 - SOL 110 – Modal complex eigenvalues
 - SOL 111 – Modal frequency response
 - SOL 112 – Modal transient response
 - SOL 129 – Nonlinear or linear transient response
 - SOL 153 – Static structural and/or steady-state heat transfer analysis with options: linear or nonlinear analysis
 - SOL 159 – Transient structural and/or transient heat transfer analysis with options: linear or nonlinear analysis
 - SOL 200 – Design optimization with option for only sensitivity analysis



Capabilities chart

Simcenter 3D Engineering Desktop

General capabilities	Specific capabilities	Simcenter 3D Engineering Desktop
Pre-processing		
Geometry import	Neutral geometry transfer (IGES, STEP, the JT™ data format, Parasolid® software)	•
	Direct geometry transfer (CATIA V4, CATIA V5, Pro/E)	+
Geometry modeling	Parasolid® software geometry kernel	•
	Parametric solid and surface modeling	•
	Direct modeling with synchronous technology	•
	Feature modeling	•
	Assembly structure creation	•
	Interpart relationship	•
	Configurations	•
	Convergent modeling (facet body editing)	+
Geometry editing prior to meshing	Direct editing with synchronous technology	•
	Defeature tools (geometry repair, feature suppression, stitch surface, remove hole/fillet, partitioning)	•
	Non-manifold topology generation for volumes	•
	Mid-surfacing (constant and variable thickness)	•
	Automatic topology abstraction	•
	Manual topology modification tools	•
	Create surface from mesh face	•
	Accept convergent model as input, push convergent model to NX CAD module	•
Meshing and modeling	Beam modeling	•
	Automated bolt connection meshing	•
	Automated shell meshing	•
	2D mapped meshing	•
	Automated tetrahedral meshing	•
	Swept hexahedral meshing	•
	Surface coating	•
	Transition meshing	•
	Axisymmetric meshing	•
	Batch meshing	•
	Mesh quality checks	•
	Material property creation and management	•
	Mass property calculations	•
	Physical property creation and management	•
	Variable element thickness	•
	Grouping	•

General capabilities	Specific capabilities	Simcenter 3D Engineering Desktop
Finite element assemblies	Hierarchical assembly management	•
	Efficient connection modeling	•
	Superelement support	+
	FE and test-based data hybrid modeling	+
Boundary conditions	Apply on geometry	•
	Apply to local coordinate system	•
	Apply on FE entities	•
	Apply on groups	•
	Axisymmetric boundary conditions	•
	Automatic contact detection and setup	•
	Automated load transfer from motion analysis	•
Import test measurement data from and map to finite element model (load recipe)	•	
External solver data deck support (import and export)	Simcenter Nastran	•
	Simcenter Samcef	+
	Abaqus	+
	ANSYS	+
	LS-Dyna	+
	MSC Nastran	+
Analysis model to design associativity	Automatic analysis model update based on geometry change	•

Legend:
 • = included in module
 + = additional product required

General capabilities	Specific capabilities	
	Simcenter 3D Engineering Desktop	
Postprocessing		
Contour displays		•
Beam cross-section contour displays		•
Vector displays		•
Isosurface displays		•
Cutting planes		•
Advanced lighting control		•
Animations		•
Complex dynamic response results		•
Multiple viewports		•
Probing of results on nodes		•
Postprocessing data table with sort/criteria		•
Results listings		•
Transparency display		•
Local coordinate system		•
XY graphing		•
Bar graphing		•
Synchronized contour and XY plotting displays		•
Annotated graphs		•
Output (JT, postscript, tif, etc.)		•
Enhanced acoustics and NVH postprocessing		+
External solver result file support	Simcenter Nastran	•
	Simcenter Samcef	+
	Abaqus	+
	ANSYS	+
	LS-Dyna	+
	MSC Nastran	+

Legend:

- = included in module
- + = additional product required



Simcenter 3D solver environments

General capabilities	Specific capabilities	Supported analysis types							
		Simcenter 3D Environment for Simcenter Nastran	Simcenter 3D Environment for Simcenter BEM Acoustics	Simcenter 3D Environment for Simcenter Samcef	Simcenter 3D Environment for Abaqus	Simcenter 3D Environment for ANSYS	Simcenter 3D Environment for LS-Dyna	Simcenter 3D Environment for MSC Nastran	
Structural analysis	Linear statics	•		•	•	•		•	
	Normal modes	•		•	•	•		•	
	Buckling	•		•	•	•		•	
	Nonlinear	•		•	•	•		•	
	Axisymmetric structural	•		•	•	•	•	•	
Structural dynamics	Modal frequency response	•						•	
	Direct frequency response	•				•		•	
	Modal transient response	•			•			•	
	Direct transient response	•				•		•	
	Random response	•							
	Complex modes	•			•				
	Superelements	•			•			•	
	Flexible bodies (for motion simulation)	•			•	•		•	
	Dynamic explicit				•		•		
	Axisymmetric dynamic explicit				•		•		
Response spectrum				•					
Advanced dynamics	Coupled fluid-structure (vibro-acoustic) analysis	•							
	Frequency response functions (FRF)	+							
	Recursive domain normal modes (RDMODES)	•							
	Fast frequency response (FASTFR)	•							
	Modal representation	+							
Thermal	Steady-state heat transfer	•		•	•	•		•	
	Transient heat transfer	•		•	•	•		•	
	Axisymmetric thermal	•		•	•	•			
Acoustics	Acoustic eigenvalues (normal modes, natural freq)	•							
	Frequency response	•	•						
	Transient response		•						
	Vibro-acoustics	•	•						
Multiphysics	Coupled thermal-mechanical	+			•	•			
	Coupled fluid-structure interaction	+							
	Coupled thermal-flow-structural	+							

Legend:

- = included in module
- + = additional product required

Note: Simcenter 3D Engineering Desktop is a minimum prerequisite for all Simcenter 3D products. Other dependency or prerequisites may apply for individual products.

SIEMENS

Ingenuity for life

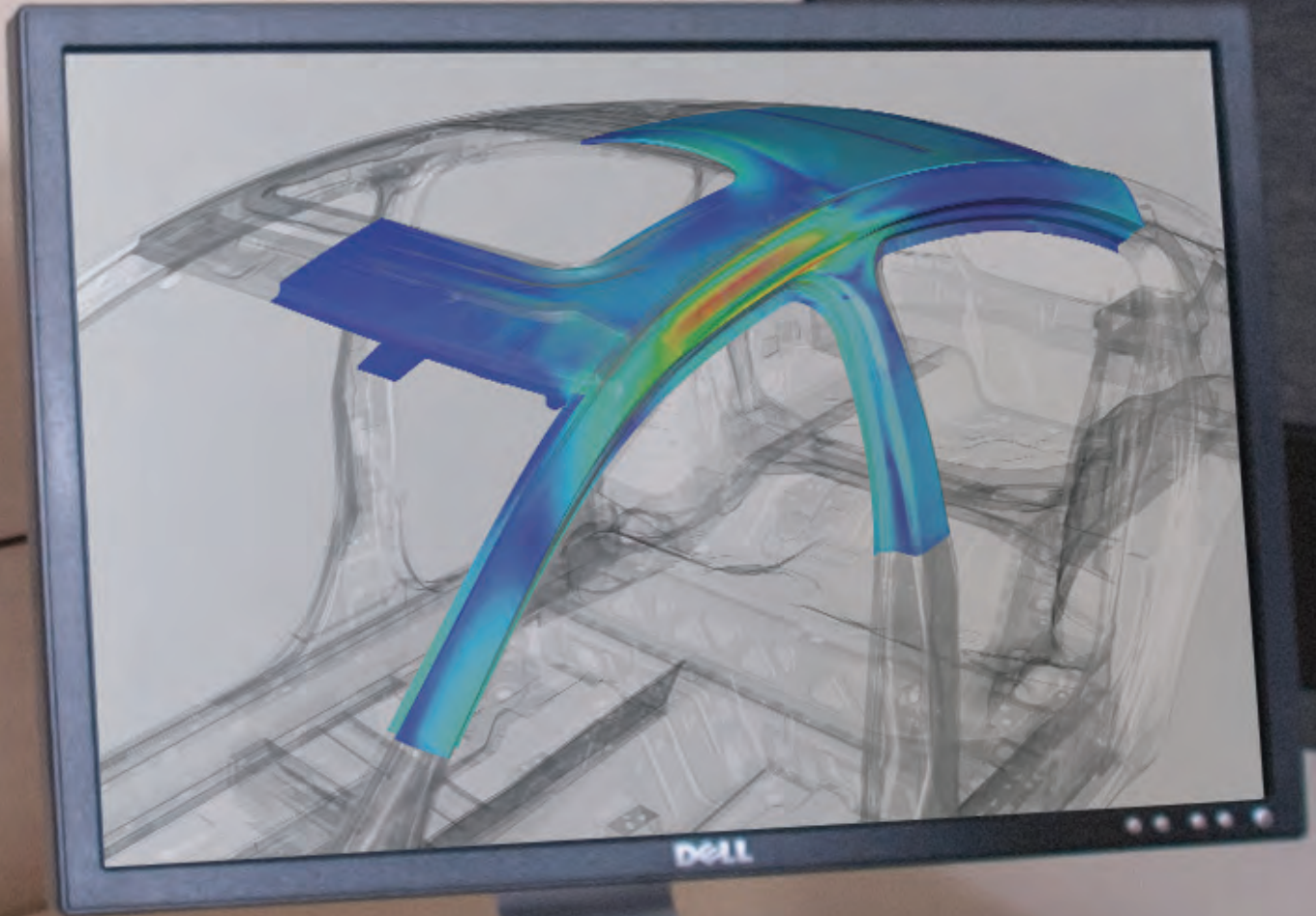

Siemens Digital Industries Software

Simcenter 3D for structural simulation

Increasing realism and improving insight

[siemens.com/simcenter3d](https://www.siemens.com/simcenter3d)



Solution benefits

- Reduce risk and cost while developing innovative structures
- Investigate product performance virtually in all possible operating conditions, including thermally influenced operating conditions
- Obtain more accurate solution results than linear analysis when standard linear assumptions are not valid
- Improve confidence in final designs by virtually investigating your product's performance in all possible operating conditions

Simcenter™ 3D software for structural simulation offers a set of finite element (FE) structural solvers that are part of the Simcenter portfolio of simulation tools. They are used by engineers across industries as part of their product development process to evaluate the structural performance of their systems.

Providing finite element solution for experienced CAE analysts

Simcenter 3D for structures is comprised of two structural solver solution sets:

- Simcenter Nastran® software
- Simcenter Samcef® software

Structural solutions of Simcenter 3D offer scalable, open and extensible capabilities for both general and advanced analysts. They can be used on laptop, workstation and servers to solve everything from small models to the largest state-of-the-art industrial models. Simcenter Nastran and Simcenter Samcef are available with enterprise licensing, which means they can be used independently from Simcenter pre/post solutions and can run on Windows and Linux operating systems.

Simcenter 3D for structural simulation

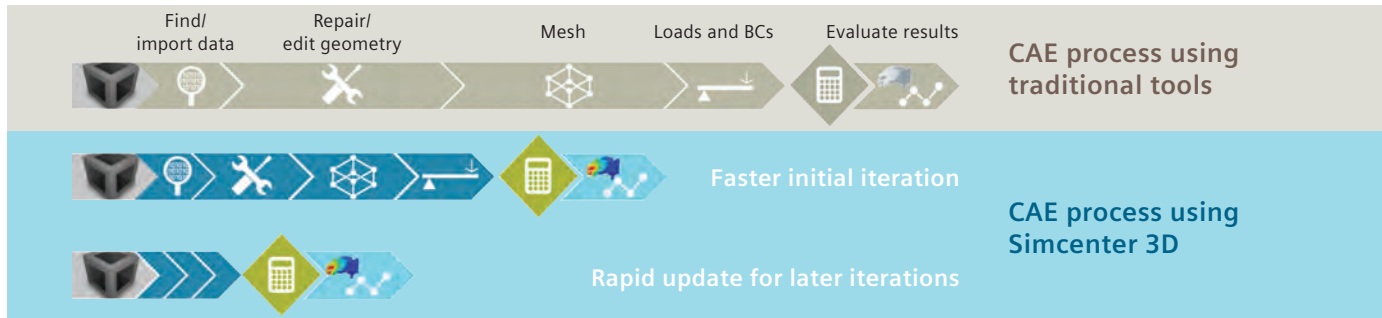

Reduce risk by using simulation to save time and cost

Simcenter 3D software addresses complex product engineering by delivering significant improvements in simulation efficiency. With advanced-capability 3D simulation technologies and powerful model preparation technology, Simcenter 3D offers new methods that increase realism and deliver better insight.

Accelerate innovation with rapid iterations

Synchronous technology in Simcenter 3D helps you reduce the time spent on model abstraction and geometry editing. Meshes, loads and boundary conditions are all associated with the base design, so when the design topology changes, you can rapidly update your simulation results. The solvers and analysis tools provide all the accuracy and speed you need for timely simulation-driven insights.

Investigate product performance virtually under all possible operating conditions

Simcenter 3D includes solvers that enable you to dive deep into the physics. Every application specialist will find state-of-the-art technology that fits the problem – static or dynamic, linear or nonlinear, composite or other, including temperature-dependant materials and thermal loads acting on a structure.

Co-simulation with Simcenter Nastran

Beyond structural solutions, Simcenter Nastran also enables co-simulation of structural, thermal and flow physics. A dedicated multiphysics environment allows you to define the complete solution on a single model, making co-simulation easily accessible to a broad set of users.

Industry applications

Simcenter Nastran and Simcenter Samcef have helped manufacturers as well as engineering suppliers in many industries with their critical engineering computing needs so they can produce safe, reliable and optimized designs within increasingly shorter design cycles.

Airframe - Aerospace and defense - Aero engines

- Airplane frame – Stiffness, frame durability, modal frequency
- Wings – Stiffness, skin buckling, modal frequency
- Airplane hatch – Seals, structural strength
- Airplane pylons, ailerons, stabilizers – Stiffness, strength
- Satellite – Thermal stress and distortion, composites, modal frequency
- Launch vehicles – Thermal stress, maneuver loads, payload bracket loads
- Launch structures – Wind loads, launch loads
- Aero engines fans – Rotating loads, distortion, composites
- Aero engines compressor – Rotating loads, thermal stress and distortion, lifing, bolt stresses, cyclic symmetry, axisymmetry
- Aero engines turbines – Rotating loads, thermal stress and distortion, lifing, creep, cyclic symmetry, axisymmetry, break-out modeling
- Aero engines casing – Bearing loads, maneuver loads

Automotive – Ground vehicles

- Body – Roof crush, panel strength, stiffness, frame durability
- Powertrain/driveline – Torque loads, thermal stress and distortion
- Chassis – Harshness loads, suspension deflections
- Off-highway vehicles – Strength, durability, rollover protective structures (ROPs), stability
- Manufacturing tools – Thermal stress and distortion, modal frequency, bolted stresses
- Support structures – Stability, stress

Marine

- Full ships – Stiffness, deformation, strength
- Hulls – Skin rupture
- Bulkheads – Structural strength

Electronics

- Hand-held equipment – Drop simulation, plastic component stress
- Printed circuit boards (PCB) – Thermal stress and distortion, solder joint strength
- Electronic boxes – Bracket strength, modal frequency

Consumer goods

- Packaging – Strength, stability, hyperelasticity, creep



Simcenter 3D Structures

Simcenter 3D Structures software is a unified, scalable, open and extensible 3D computer-aided engineering (CAE) environment for advanced analysts. Simcenter 3D Structures is a bundle combining the Simcenter 3D Engineering Desktop, Simcenter Nastran environment and the Simcenter Nastran Basic solver. Together, Simcenter 3D Structures gives you best-in-class simulation modeling with the power to perform basic structural analysis with an industry-standard solver. The Simcenter 3D Engineering Desktop contained in Simcenter 3D Structures speeds the simulation process by helping you efficiently build the simulation model you need from 3D geometry faster than traditional CAE preprocessors. The integrated Simcenter Nastran solver in Simcenter 3D Structures lets you seamlessly submit analysis models for linear statics, normal modes, buckling and basic heat transfer analyses. Simcenter 3D Structures also forms the foundation on which you can add additional solutions for advanced structural, thermal, flow, acoustics, motion, optimization and multi-physics analyses, all from a single environment.

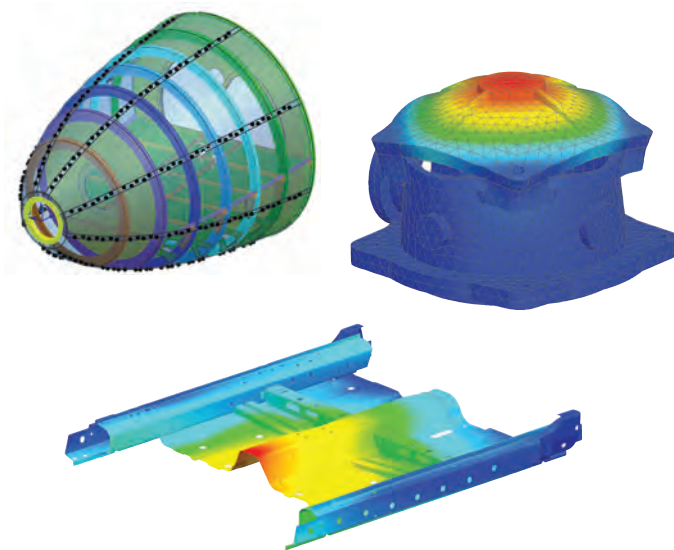

Module benefits

- Speed simulation processes by up to 70 percent
- Perform accurate, reliable structural analysis with the integrated Simcenter Nastran Basic solver
- Increase product quality by rapidly simulating design tradeoff studies
- Lower overall product development costs by reducing costly, late design change orders
- Efficiently manage large, complex analysis models
- Capture and automate best practices and commonly used processes
- Easily add multidiscipline simulation capabilities as your analysis needs grow

Key features

- All-inclusive software package with Simcenter 3D Engineering Desktop for pre/post together with Simcenter Nastran Basic for structural analysis
- NX is a leading geometry kernel which is used as part of Simcenter 3D to provide rapid geometry editing and abstraction
- Comprehensive meshing tools combined with efficient FE assembly management
- Immerses engineers in the Simcenter Nastran environment by using familiar terminology and extensive support of product-specific elements and entities
- Simulate structural analysis for linear statics, normal modes, buckling and heat transfer using the trusted Simcenter Nastran solver

Simcenter Nastran

Simcenter Nastran allows you to initiate digital simulation into your product development process by providing access to a broad library of finite element types and material models, robustly manipulating load cases and delivering several efficient solution sequences for analyses on models of unlimited size. You can also perform sensitivity studies based on these analysis types.

The Simcenter Nastran basic license comes with a full base set of structural capabilities as the entry point for Simcenter Nastran. It also comes with a basic heat transfer solver and the resulting temperatures can be used as loads in a structural solution.



Module benefits

- Reduce risk by using simulation to save time and cost compared to physical test cycles
- Accelerate innovation with rapid iteration and numerous what-if studies
- Investigate product performance virtually under all possible operating conditions, including thermally influenced operating conditions

Key features

- Linear statics, normal modes, buckling
- Design sensitivity
- Basic nonlinear
- Composites
- Shared memory parallel (SMP) processing

Beyond the base set of capabilities, users can add more advanced structural capabilities including:

- Multistep nonlinear (static, transient)
- Distributed memory parallel (DMP) processing
- Linear dynamics (transient, frequency, random)
- Rotor dynamics
- Design and topology optimization
- Aeroelastic
- Vibroacoustic

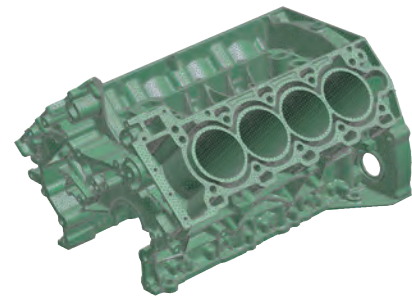
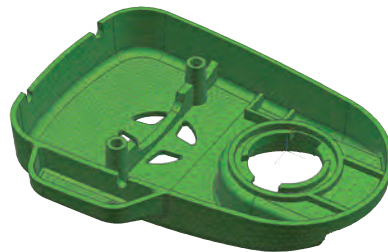
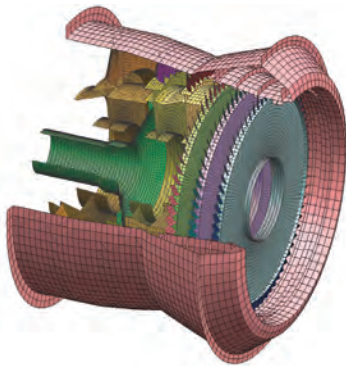

Simcenter Nastran Multistep Nonlinear

Simcenter Nastran Multistep Nonlinear is an advanced solution that provides comprehensive capabilities for geometric nonlinear, contact, plasticity, creep, hyperelasticity and other material behaviors. The multistep solution allows users to set up sequential subcases for preload, nonlinear statics, nonlinear transient, modal, buckling, post buckling and harmonic modes.

This is an add-on product to a basic license that provides two nonlinear solution options: Simcenter Nastran solution SOL 401 and SOL 402. Both are suited to a similarly wide range of nonlinear problems, but each also has unique features.

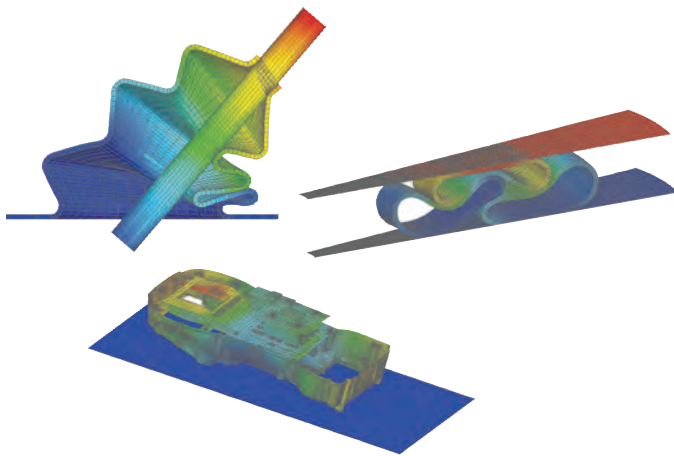

Module benefits

- Use the same models already built and analyzed linearly with Simcenter Nastran Basic
- Improve confidence in final designs by virtually investigating your product's performance under all possible operating conditions
- Obtain more accurate solution results than linear analysis when standard linear assumptions are not valid

Key features

- Static/dynamic analysis of models, including material and geometrical nonlinear behaviors
- Multistep solver allowing the following analysis types in different steps: static, dynamic, preload, modal, buckling, cyclic symmetry modes, Fourier harmonic modes
- Material nonlinear: hyperelasticity models (Mooney-Rivlin, Ogden, hyperfoam, Mullins effect, damping with Prony series), elastoplastic (Von Mises yield criterion, isotropic hardening, kinematic hardening, mixed hardening), thermal elastoplastic, creep, combined creep and elastoplastic
- Geometrical nonlinear: Large deformations, large strain, snap-through analysis (post buckling), follower forces
- Contact: Shell and solid element face contact, edge contact for axisymmetric modeling, single- and double-sided contact, self-contact, multiple friction models, tied contact, contact surface offsets, gap elements, contact activation/deactivation per subcase, contact pressures and force results, contact separation and sliding results

Simcenter Nastran DMP

Simcenter Nastran DMP is an add-on module to Simcenter Nastran Basic. It enables parallel processing using distributed memory. It is an efficient approach to solving large models and can be used on workstations with multiprocessors using Windows. DMP solutions are available for static solves (SOL 101), modal eigenvalue solves (SOL 103), modal dynamic response solves (SOL 111 and 112), direct frequency solves (SOL 108) and nonlinear solves (SOL 401 and SOL 402). DMP can also be used in combination with SMP, which comes as part of Simcenter Nastran Basic.

Module benefits

- More cores provide faster solutions
- Allows solving large models that are not possible to solve on a single central processing unit (CPU)

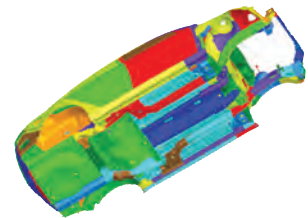
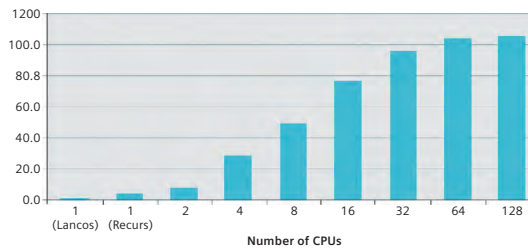
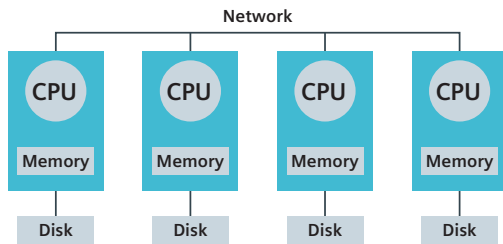
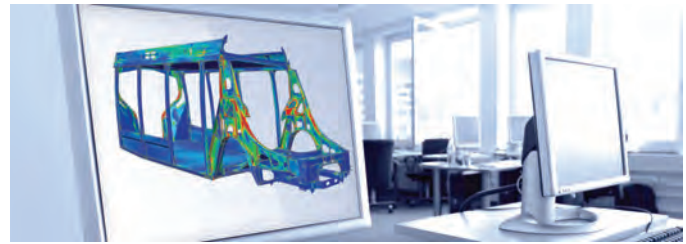

Capabilities chart

General capabilities	Specific capabilities	Simcenter 3D Structures	Simcenter Nastran Basic	
Linear structural solutions	Statics	•	•	
	Dynamics (see Simcenter 3D for structural dynamics for details)			
	Normal modes	•	•	
	Superelements			
	Buckling	•	•	
	Restarts	•	•	
	Parallel memory processing	•	•	
	Elements			
	3D solids	•	•	
	2D solids	•	•	
	Shell	•	•	
	Membrane	•	•	
	Beam	•	•	
	Springs	•	•	
	Rods	•	•	
	Rigid	•	•	
	Composites			
	Short fiber	•	•	
	Long fiber	•	•	
	Connections			
	Bolt preloads	•	•	
	Contact connections	•	•	
	Glue connections	•	•	
	Materials			
	Isotropic	•	•	
	Orthotropic	•	•	
	Anisotropic	•	•	
	Temperature dependence	•	•	
	Loads/boundary conditions			
	Gravity	•	•	
	Force/moment	•	•	
	Pressure	•	•	
Rotational	•	•		
Temperature	•	•		
Enforced motion	•	•		

General capabilities	Specific capabilities	Simcenter 3D Structures	Simcenter Nastran Basic	Simcenter Nastran Multistep Nonlinear	
Nonlinear structural solutions	Large displacement effect			•	
	Large strain effect			•	
	Contact	•	•	•	
	– Coulomb friction	•	•	•	
	– Other friction models			•	
	Nonlinear materials				
	Plasticity			•	
	– Temperature dependence			•	
	– Bilinear			•	
	– Multilinear			•	
	– Isotropic hardening			•	
	– Kinematic hardening			•	
	Creep			•	
	Hyperelastic material			•	
	Nonlinear elastic material			•	
	Gasket material			•	
	User defined material			•	
	Composite				
	Cohesive delamination			•	
	Progressive failure			•	
	Curing simulation				
	Algorithms				
	Static nonlinear (implicit)			•	
	Transient nonlinear (implicit)			•	
	Thermal mechanical co-simulation			•	
	Fluid-structural co-simulation			•	
	Modal about nonlinear state			•	
	Complex modal about nonlinear state			•	
	Buckling about nonlinear state			•	
	Multistep			•	
	Arc-length			•	
	Cyclic symmetry modes			•	
Multi-harmonic modes			•		
Restart			•		
Element add/remove			•		

General capabilities	Specific capabilities	Simcenter 3D Structures	Simcenter Nastran Basic	Simcenter Nastran Multistep Nonlinear
Nonlinear structural solutions	Loads/boundary conditions (for nonlinear analyses only)			
	Distributed force			•
	Fluid pressure penetration			•
	Initial stress/strain			•
	Geometry imperfections			•

Legend:

• = included in module

Note: Simcenter 3D Engineering Desktop is a minimum prerequisite for all Simcenter 3D products. Other dependency or prerequisites may apply for individual products.

SIEMENS

Ingenuity for life

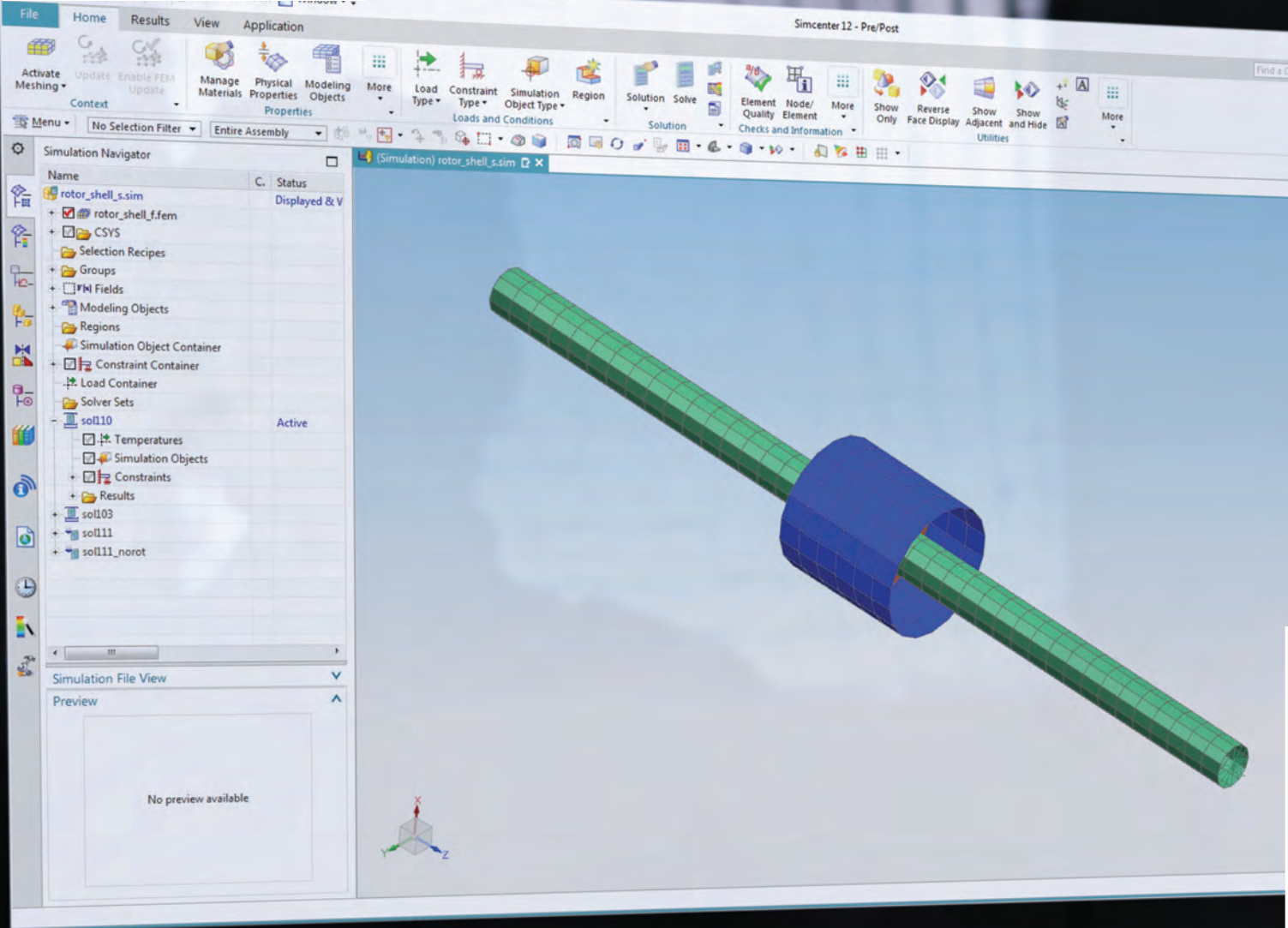

Siemens Digital Industries Software

Simcenter 3D for structural dynamics simulation

Providing rapid insight into the dynamic response of structural systems

[siemens.com/simcenter3d](https://www.siemens.com/simcenter3d)



Solution benefits

- Perform comprehensive dynamic analysis and accelerate product time-to-market
- Improve confidence in design by using Simcenter Nastran to investigate the product's performance under dynamic operating conditions
- Get insight and improve NVH performance by dedicated tool set for NVH postprocessing and troubleshooting
- Combine FE with measured data as loading or component's description for more realistic simulations and hybrid assemblies
- Rapidly evaluate and improve the dynamic performance of rotating systems
- Improve accuracy and increase confidence in your FE models by correlating with actual measured data

Simcenter™ 3D software offers a comprehensive solution to understand, analyze and improve the response when a system is subjected to dynamic loading. This includes the industry standard Simcenter Nastran® software for dynamic analysis as well as interactive solutions for general dynamic analysis in order to efficiently understand and avoid excessive vibrations and stresses. Moreover, dedicated capabilities are available for noise, vibration and harshness (NVH) engineering, rotor dynamics and correlation.

Advancing structural dynamics prediction

Starting from the product concept phase, analysts and specialists can rely on Simcenter 3D structural dynamics solutions to analyze design decisions and systematically improve dynamic characteristics of the system. The graphical user interface (GUI) of Simcenter 3D is fully customizable to suit your dynamic analysis processes by creating predefined templates and streamlining the product engineering process.

Simcenter 3D for structural dynamics simulation

NVH and rotor dynamics

Dedicated interactive and solver solutions are available to support industry workflows for NVH and the dynamics of rotating machinery.

Uniquely combine real-world test data in the simulation

Using Simcenter 3D for structural dynamics solutions enables you to implement a distinctive hybrid simulation approach to leverage measured data as a component representation in a system-level finite element (FE) model, or to apply real-life loading to accurately and robustly accelerate the engineering process.





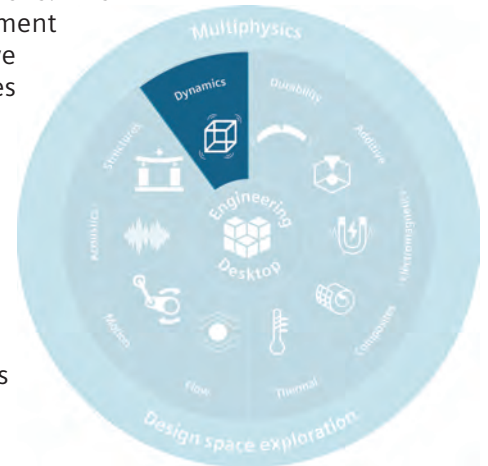

Increasing confidence in dynamic FE models

An integral part of making product engineering decisions is having confidence in the simulation models so you can accurately predict reality. Correlation solutions allow you to validate and improve the dynamic behavior of simulation models from physical test data.

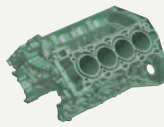
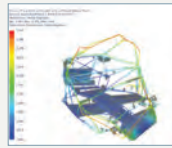
Providing a platform for multidiscipline simulation

The Simcenter 3D structural dynamics solution is part of a larger, integrated multidiscipline simulation environment with the Simcenter 3D Engineering Desktop at the core for centralized pre-/postprocessing for all Simcenter 3D solutions. This integrated environment helps you to achieve faster CAE processes and streamline multidiscipline simulations that integrate dynamics and other disciplines like computing dynamic loads from motion, flow or electromagnetics solution.

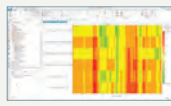

Preprocessing	Pre-test and correlation	Multilevel assembly	Connections modeling	Cavity mesh	Loads	Solution	Postprocessing
<p>Defeating, synchronous technology, convergent modeling, multi-CAD support, component meshing, boundary conditions</p> 	<p>Senor and exciter locations, Operational deflection shape, modal assurance criterion (MAC), coordinate MAC, modal scale factor (MSF), cross-orthogonality</p> 	<p>Component models sub-assembly, hybrid modeling with test modes and FRFs, automatic assembly label resolution</p> 	<p>Universal connections, automated weld, joints, spring, damper bolt, and sealing identification</p> 	<p>Solid to shell meshing, surface wrap, polygon body</p> 	<p>Loads from measured data, dynamic loads from Simcenter 3D motion, mapped dynamic loads electro-magnetics, enforced vibration loads</p> 	<p>Model reduction techniques -modal, super-elements, FRFs</p> 	<p>Modal, grid path, panel and structural model contribution, energy contributions, radiated power</p> 

What-if, optimization, feedback to designer

NVH workflow

Industry applications

Since most systems are subjected to loading that is dynamic in nature at some point in the lifecycle, understanding the dynamic behavior of structures is an important topic in many fields. Simcenter 3D provides a complete solution to predict dynamic behavior, be it for a component, subsystem or the complete system.

Automotive and transportation

NVH performance strongly impacts the driving experience and perception of quality. Simcenter 3D offers integrated tools and solvers to predict NVH characteristics and analyze the root cause of noise and vibration problems.

Aerospace and defense

Simcenter 3D helps you identify the structural weaknesses of a given design and optimize the vibration and dynamic performance of aeronautical structures subjected to dynamic loading. Dedicated solutions for rotor dynamics help you assess the performance of aero-engines to avoid instabilities.

Industrial machinery

Machines that excessively vibrate during operation directly impact the quality of the manufactured product. Simcenter 3D delivers insights into the possible cause of machine vibrations, including rotating machinery.

Electronics and consumer goods

Simcenter 3D helps predict the dynamic characteristics of electronics and consumer goods to avoid excessive vibrations and stresses, which could result in fatigue or catastrophic failure.

Marine

With an increasing demand for faster and lightweight ships, design engineers can rely on Simcenter 3D to predict the response of the overall structure and its individual components that are subjected to wave and current actions.

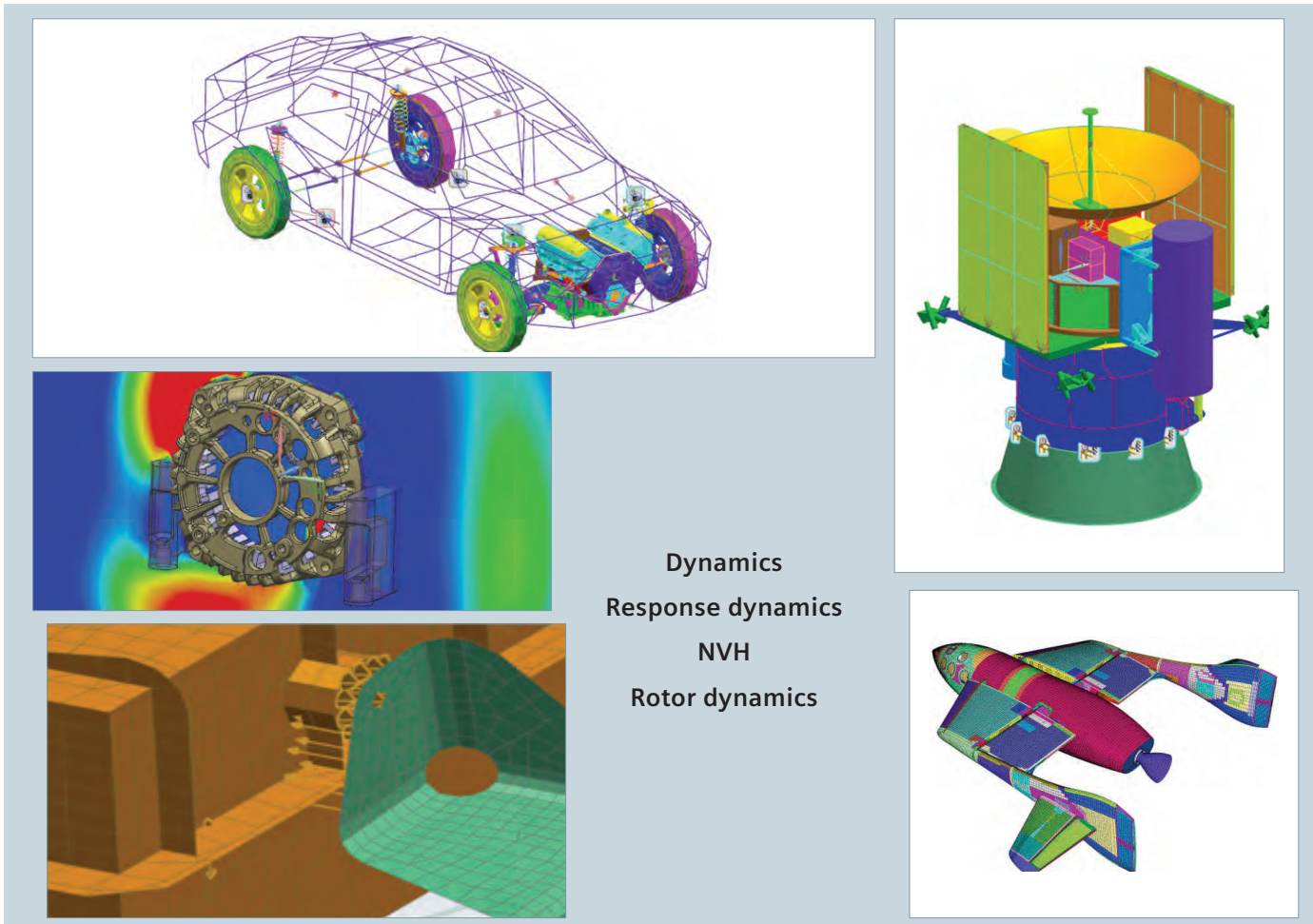

Simcenter 3D Response Dynamics

Simcenter 3D Response Dynamics software is an integrated solution that makes dynamic analysis more accessible and efficient for the analyst. It allows you to predict the forced response of structural systems under various loading conditions in a single graphical user environment, thereby eliminating the complexity of setting up and launching analysis and providing rapid insight into dynamic behavior. Analysis information can then be used to perform design studies to enhance the new product development process and confirm the quality of designs prior to physical prototyping and production.

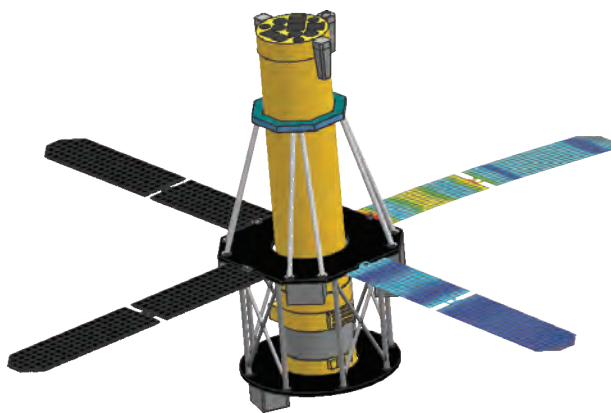
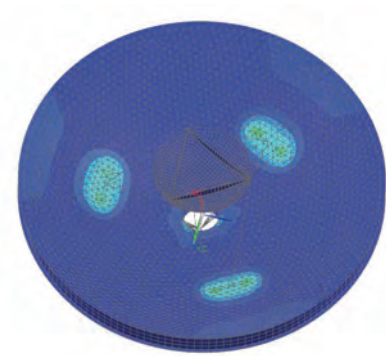

Module benefits

- Gain rapid insight into the dynamic response of structural systems
- Quickly generate and view results graphically
- Leverage all capabilities of Simcenter 3D to make quick design changes and provide rapid feedback on dynamic performance

Key features

- Predict model response to transient, frequency (harmonic), random vibratory, shock spectrum, dynamic design analysis method (DDAM) (ship's shock loads) and quasi-static loads
- Efficiently calculate responses using a modal formulation starting from a priori solved set of Simcenter Nastran mode shapes
- Import, generate and edit the excitation information from computer-aided engineering (CAE) analysis and test data, including force, enforced motion and distributed loads (for example, dynamic pressure)
- Seamlessly interface analytical models with measured test data for instance-measured accelerations used for base-excitation loading



Simcenter 3D Noise and Vibration Modeling

Simcenter 3D Noise and Vibration Modeling offers a comprehensive set of noise and vibration pre/post capabilities addressing your need to build, understand, evaluate and optimize the noise and vibration performance of complete system and assembly models.

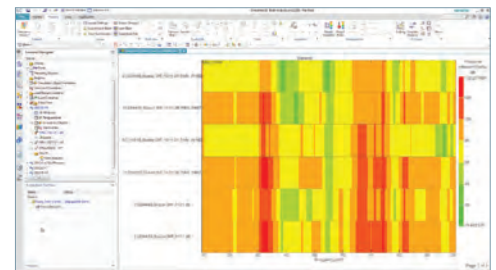
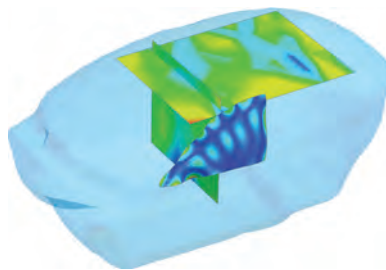
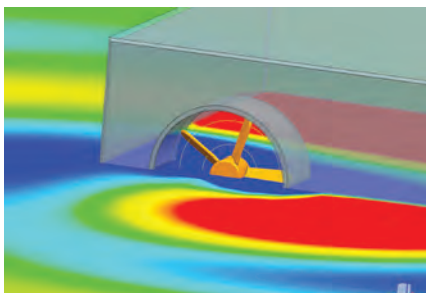
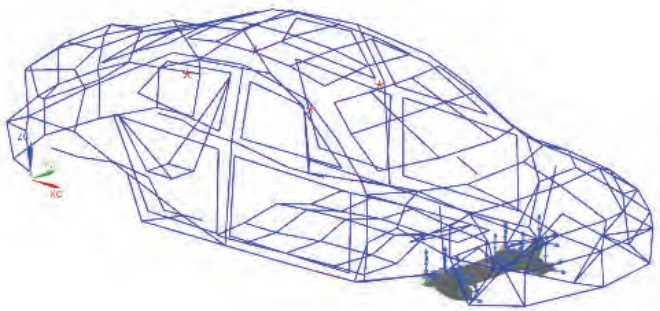
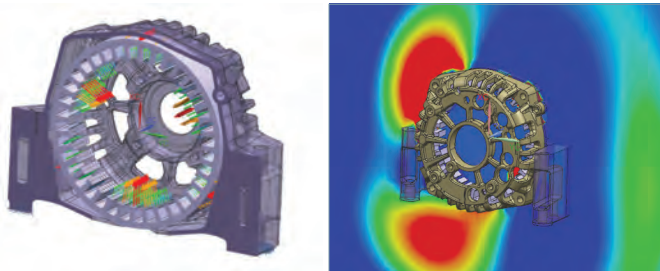

Module benefits

- Gain valuable insight into the noise and vibration performance of your design
- Use data from measurements and previous simulations to create relevant load cases
- Use dynamically equivalent, reduced component representations in your assembly model to speed up response analysis

Key features

- Intuitive noise and vibration diagnostics with support from modal, grid, panel, energy and path-contribution analysis
- Map test data and predecessor simulation data – multibody, electromagnetics (EM), computational fluid dynamics (CFD) – onto the vibro-acoustic simulation model, including time-to-frequency domain conversion for obtaining realistic loads
- Include frequency response function (FRF) and modal representations for structural components in assembly context using either simulation or test data
- Include acoustic transfer vectors (ATV) or vibro-acoustic transfer vectors (VATV) representations for acoustic or vibro-acoustic components, which are re-usable for multiload case scenarios for powertrain noise or cabin wind noise

Simcenter 3D Load Identification

Simcenter 3D Load Identification enables you to get accurate dynamics loadings of a structure. Operational loads are very important for accurate response prediction but are often impossible or difficult to measure directly. This product offers several ways of identifying the operational forces from measured data, either by mount stiffness method or inverse matrix method. For instance, in an inverse matrix method the operational vibration data can be measured in operational conditions and the transfer functions (FRFs) can be measured in controlled lab conditions or be obtained from simulations. These data are then combined in an inverse load identification case.

Module benefits

- Determine operational forces which is difficult or impossible to measure directly
- Get more realistic simulation by applying more accurate loading
- Combine measured loading data with FE simulations

Key features

- Mount method to estimate mount forces by combining operational vibration data at each side of the mount and mount stiffness data
- Inverse matrix method by combination of operational measurements and transfer functions
- Based on all measured data or a combination of operation measurements and simulation data
- Straightforward application and reuse of the identified forced to the simulation model

Test



Mount stiffness method

- Operational vibrations on both ends of the mounts are measured
- Mount stiffness FRFs measured in lab



$$F(\omega) = K(\omega)[X_s(\omega) - X_t(\omega)]$$

Inverse matrix method

- Operational vibrations are measured
- FRFs measured in lab

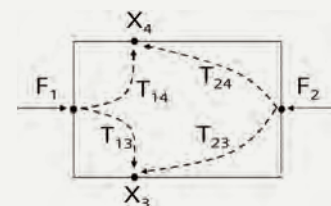

$$\begin{bmatrix} F_1 \\ F_2 \end{bmatrix} = \begin{bmatrix} T_{13} & T_{23} \\ T_{14} & T_{24} \end{bmatrix}^{-1} \begin{bmatrix} X_3 \\ X_4 \end{bmatrix}$$

Simcenter 3D NVH Composer

The Simcenter 3D NVH Composer is a streamlined product to create full vehicle level FE models for NVH starting from subassembly models (BIW, Door, Suspension...).

The product offers an interactive network display to define the topology of the full vehicle assembly by defining components, connectivity information and lumped mass trim information. Once the full vehicle layout is defined, the assembly is automatically created in Simcenter 3D and syncs it with the network display which is a simplified way to interact with the full vehicle assembly. All typical connections between full vehicle subsystems are available and the modeling is done for Simcenter Nastran.

Module benefits

- Increase productivity and speed up full vehicle creation time
- Decrease human error by capturing assembly topology in layout files
- Take out the complexity of full vehicle assembly model creation
- Rerun easily in case of component changes

Key features

- Interactive network display to define full vehicle topology starting from subsystem FE models
- All typical full vehicle connections are supported (bolt, bushing, weatherstrip/sealing,...)
- Support of lumped mass trimming
- Automatic assembly from the defined full vehicle topology
- Integrated checking functionality
- Automatic synchronization between Simcenter 3D NVH Composer and resulting Simcenter 3D assembly

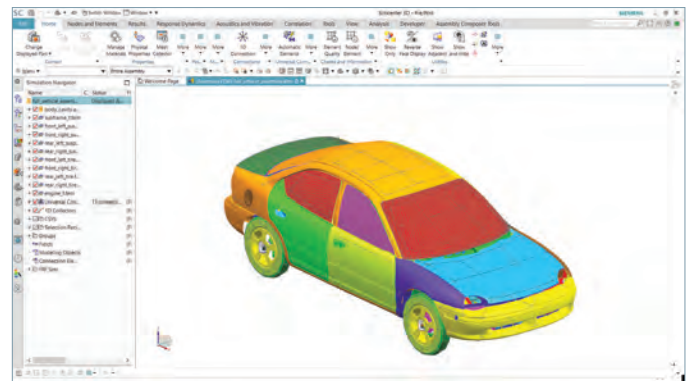
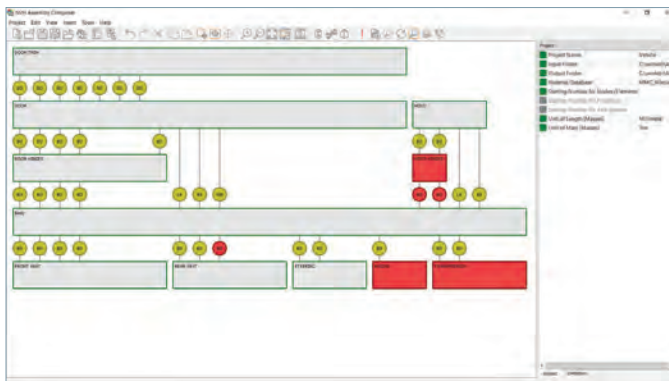

Simcenter 3D FE Model Correlation

Simcenter 3D FE Model Correlation software enables you to quantitatively and qualitatively compare simulation and test results, as well as two different simulations. It provides the tools needed to geometrically align the models, pair the modes from both solutions, view mode shapes and frequency response functions and calculate/display correlation metrics.

Module benefits

- Validate the accuracy of the finite element model for dynamic analysis
- Determine optimal sensor and exciter locations before performing physical modal tests
- Increase productivity by enabling model validation in the same environment as used for model creation and analysis

Key features

- Supports Simcenter Nastran, Simcenter Samcef® software, Abaqus, ANSYS and MSC Nastran results
- Test solution import using universal files or Simcenter Testlab™ software files
- Pretest planning for optimal number and location of sensors and exciters
- Intuitive and powerful test model alignment
- Automatic and manual mapping of FE model nodes and test sensors
- Variety of mode-pairing options and correlation criteria
- Interactive correlation with matrix and mode-shape displays

Correlation modal assurance criteria (MAC) results

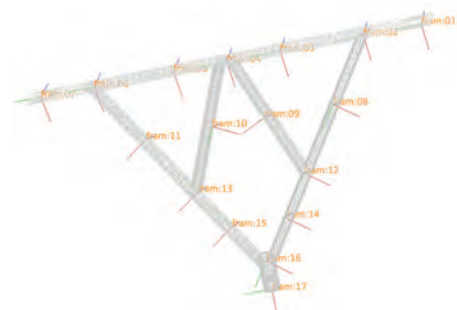
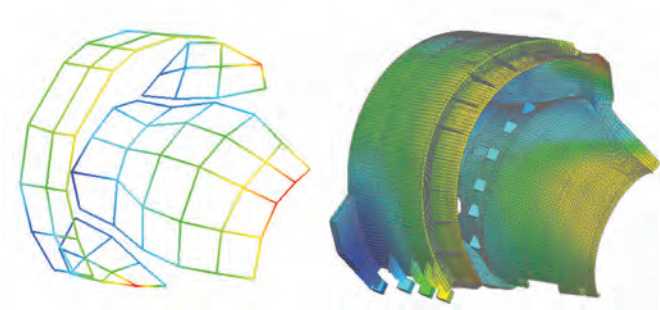
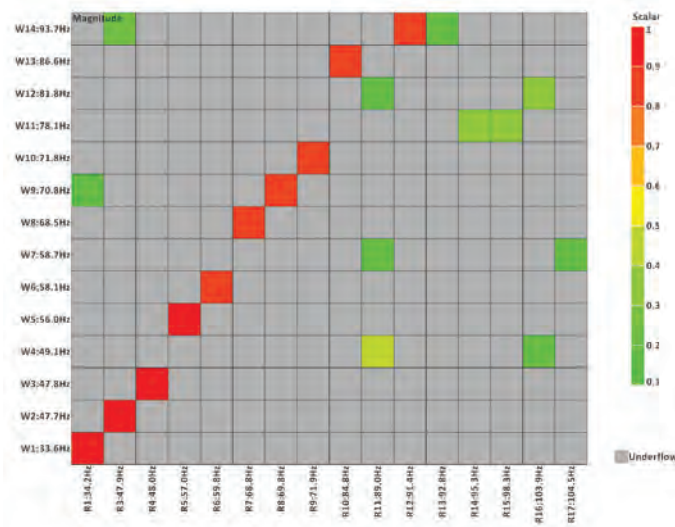

Simcenter 3D FE Model Updating

Simcenter 3D FE Model Updating software is an advanced correlation tool designed to automatically update FE models to match real-life test data. The tool is fully integrated with Simcenter 3D structure modules, making the updating process efficient, intuitive and productive.

Module benefits

- Improve accuracy and increase confidence in your FE models
- Increase productivity by performing model updating in the same environment used for model creation and analysis
- Provide quick sensitivity-based approach

Correlation modal assurance criteria (MAC) results

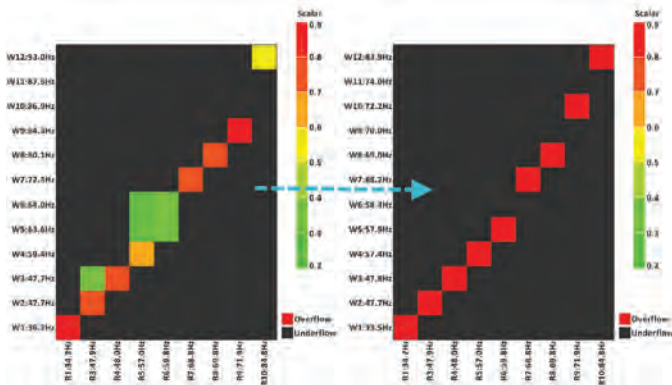

Before and after update.

Key features

- Support material and physical property design variables such as beam section areas, shell or laminate ply thickness and Young’s modulus
- Automatic generation of multiple design variables
- Automatic and manual design variable management
- Targets include modal frequencies, mode shape modal assurance criterion (MAC) and mode shape cross-orthogonality
- Simcenter Nastran or MSC Nastran SOL 200 licenses not required
- Embedded eigenvalue solver to achieve accurate updating of results in few iterations
- Automatic update of finite element method (FEM) that can be easily cascaded to all simulations

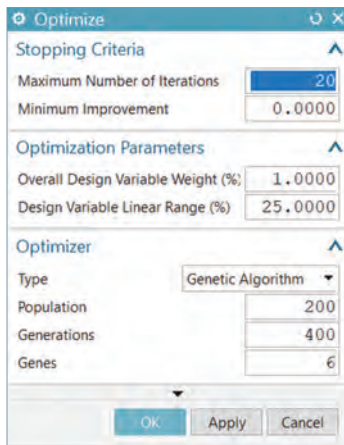

ID	Name	Label	Value	Lower Bound	Upper Bound	Weight	Phy
6	Multiple Create DV S235JR_MASSLES...	M114E	0.512	0.200	2.000	1.000	S23
7	Multiple Create DV S235JR_MASSLES...	M115E	1.076	0.500	2.000	1.000	S23
8	Multiple Create DV S235JR_MASSLES...	M117E	0.904	0.500	2.000	1.000	S23
9	Multiple Create DV S235JR_MASSLES...	M118E	0.728	0.500	2.000	1.000	S23
1.	Multiple Create DV S235JR_MASSLES...	M116E	0.905	0.500	2.000	1.000	S23
1.	Multiple Create DV TUBE_40_37 11 11	P4411	0.510	0.200	2.000	1.000	TUJ
1.	Multiple Create DV TUBE_40_37 12 12	P4412	1.143	0.500	2.000	1.000	TUJ
1.	Multiple Create DV TUBE_40_37_1 11 ...	P4511	1.654	0.500	2.000	1.000	TUJ
1.	Multiple Create DV TUBE_40_37_1 12 ...	P4512	0.690	0.200	2.000	1.000	TUJ
1.	Multiple Create DV TUBE_40_37_2 11 ...	P4611	1.214	0.500	2.000	1.000	TUJ
1.	Multiple Create DV TUBE_40_37_2 12 ...	P4612	0.529	0.200	2.000	1.000	TUJ

Simcenter Nastran Dynamic Response

Simcenter Nastran Dynamic Response software is the core solver for dynamic finite element analysis (FEA). It enables the forced response analysis of a component or assembly subject to time- or frequency-varying excitations. Assessing dynamic response under different operating conditions is critical to industries such as automotive, aerospace, consumer products and other sectors that rely on electronic devices. It is possible to perform numerous what-if studies by virtually investigating the product's performance in various dynamic operating conditions by using the rich analysis tool set supported by Simcenter Nastran Dynamic Response.



Module benefits

- Assess dynamic performance of your physical model
- Apply to all applications, industries and model sizes
- Save time and cost compared to physical build-test-break cycles

Key features

- Comprehensive dynamic response set. Supports frequency, transient, complex eigenvalue, random response, shock spectrum and other analysis
- Includes a list of eigenvalue solvers such as Lanczos, Householder, Hessenberg, etc.
- Supports numerous types of dynamic loading in time and frequency domain
- Fast frequency response solvers applicable to large models

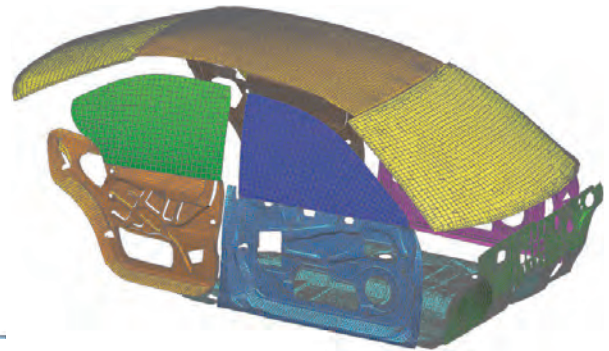
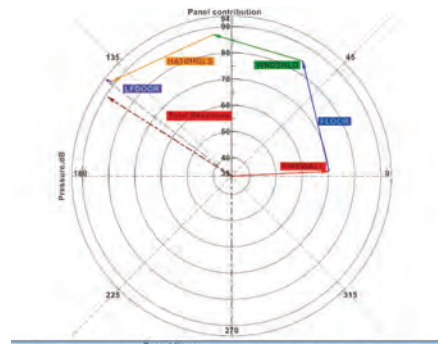
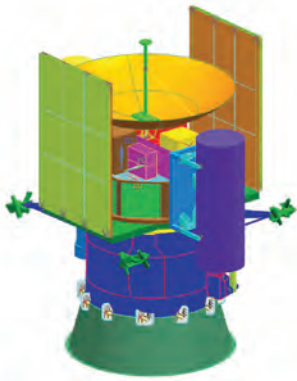

Simcenter Nastran Advanced Dynamics bundle

Simcenter Nastran Advanced Dynamics is a cost-effective bundle that provides a set of commonly used and advanced dynamics functionality, which includes Simcenter Nastran Dynamic Response, Simcenter Nastran FRF representations, Simcenter Nastran super-element analysis, Simcenter Nastran recursive domain (RD) modes, Simcenter Nastran DMP (distributed memory processing), Simcenter Nastran aeroelasticity and Simcenter Nastran direct matrix abstraction program (DMAP).

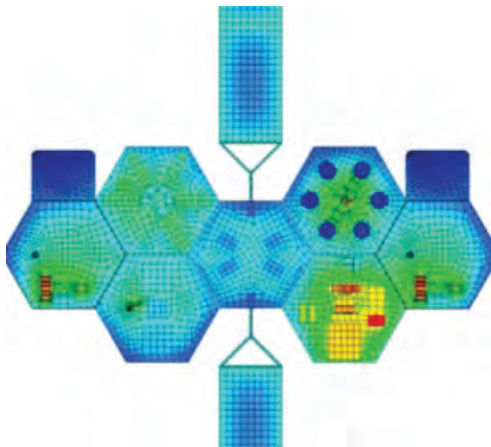

Module benefits

- Use cost-effective bundle to perform comprehensive dynamic analysis and accelerate product time-to-market
- Build system assembly models using a hybrid assembly of components based on finite elements and test measurements or reduced order models

Key features

- Includes all capabilities of Simcenter Nastran Dynamic Response
- Includes Simcenter Nastran FRF representation
- Computes the forced response of a product subject to time or frequency varying excitations
- Represents a component in the form of frequency response function, an alternate form of matrix representation of a component
- Large models consisting of more than 300 modes can be efficiently solved using recursive domain normal modes (RDMODES)
- Analyze structural models in the presence of an airstream using aeroelastic analysis
- Modify and adapt out-of-the-box (OOTB) solution sequences using DMAP

Simcenter Nastran DMP

Simcenter Nastran DMP facilitates a significant reduction in computing time by using multiple processors and computing resources. Simcenter Nastran DMP enables a higher level of parallelism and provides better scalability than shared memory processing (SMP).

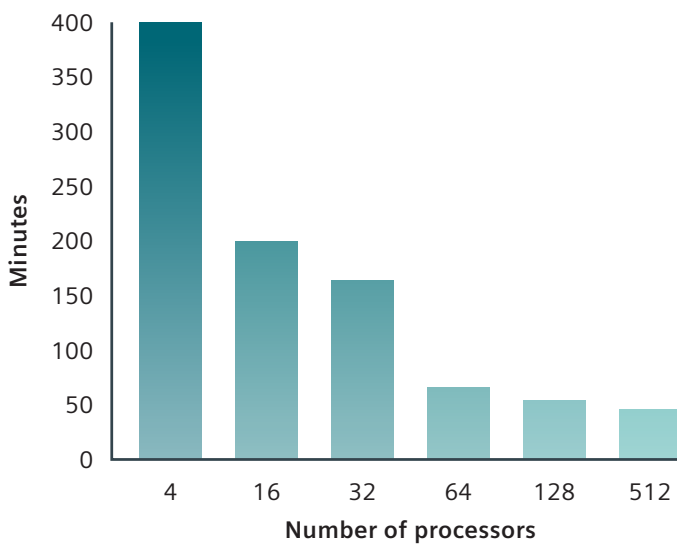

Module benefits

- Rapidly solve complex large problems
- Use the DMP solution to solve large problems more than 100 times faster than the Lanczos method on a single processor

Key features

- Simcenter Nastran has many options for partitioning solution domains, such as geometric, frequency, hierarchic, load and recursive domain partitioning
- DMP can also be operated on a single node that has multiple processors
- Supported dynamic solution types are modal and direct frequency response, eigenvalue computation and modal transient

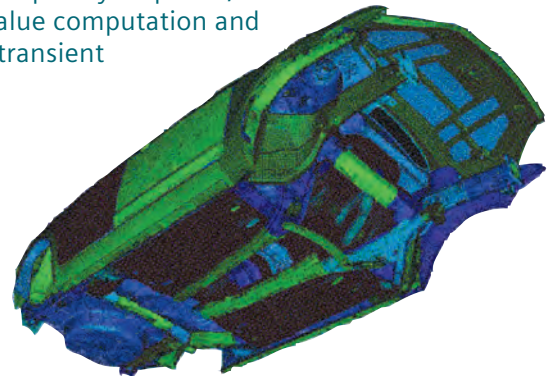

Simcenter Nastran Rotor Dynamics

Rotating systems are subject to gyroscopic forces such as Coriolis and centrifugal forces that are not present in stationary systems. Simcenter Nastran Rotor Dynamics software provides the capability to predict the linear dynamic behavior of rotating systems. Users can simulate rotating system loads, perform synchronous and asynchronous analysis to generate Campbell Diagram data, predict whirl frequencies and critical speeds and detect instability in rotating components.

Module benefits

- Rapidly evaluate and improve the dynamic performance of rotating systems prior to physical prototyping and production commit in a fully integrated CAE environment
- Evaluate and develop optimal in-service design modifications to increase production process throughput of rotating equipment systems

Key features

- Compute critical speeds and whirl frequencies from Campbell diagrams
- Study the linear dynamic behavior of the rotating system under rotor imbalance or any frequency-dependent (synchronous or asynchronous) or time-dependent excitation
- Analyze symmetric and asymmetric rotor models, as well as multiple rotors with different rotation speeds and orientations
- Include differential stiffness to compute centrifugal softening effects
- Solve the model in the fixed or rotating coordinate reference system

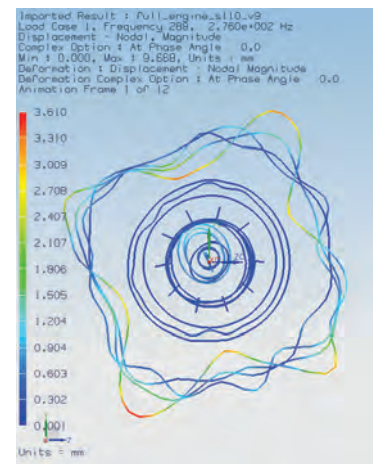
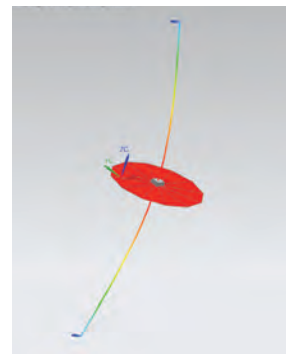
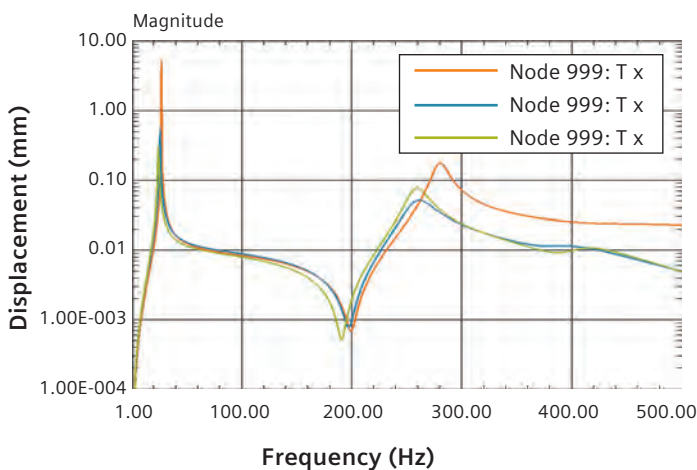
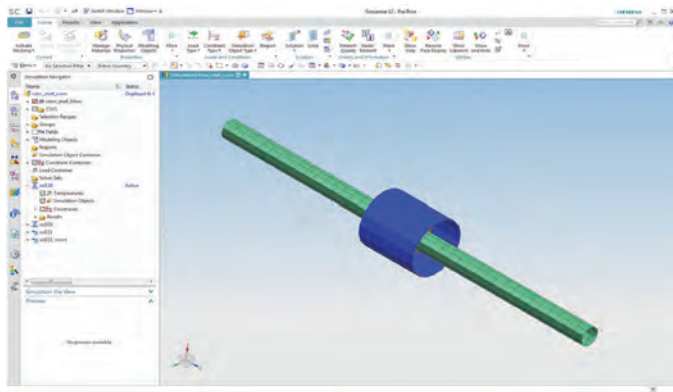

Simcenter Samcef Rotor

Simcenter Samcef® software, rotor module is a solution for simulating the behavior of high-speed rotating machines such as turbo machines, aero-engines, propellers, fans, etc. The solution is tailored specifically for rotor dynamics specialists and more generally for engineers focusing on global dynamics of rotating machines. Simcenter Samcef Rotor is a standalone solution that includes a dedicated pre-post environment, and solver modules for linear and nonlinear computations as well as superelement creation and recovery.

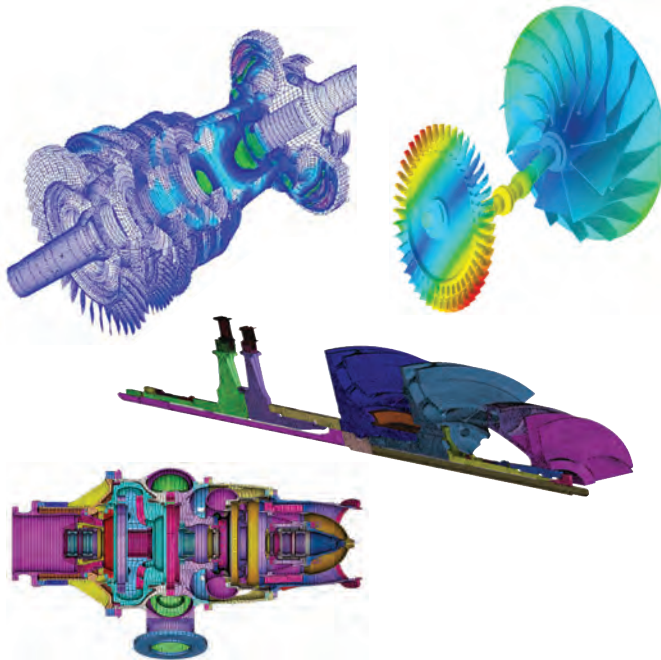

Module benefits

- Enable the study of large problems in complex and realistic scenarios
- Perfectly simulate the global dynamics of the rotor and stator assembly
- Achieve accurate simulations by taking nonlinear effects into account in connection elements
- Reduce the vibration level and avoid harmful resonances by predicting them
- Improve product performance and reduce costly physical prototypes

Key features

- Build the most accurate rotor dynamic models thanks to a large library of elements (1D, 3D, 2D Fourier multi harmonics, cyclic symmetry, etc.), taking advantage of symmetry with maximum flexibility
- Powerful model reduction by superelements to include reduced representations in larger assembly models
- Library of bearings and seals (rolling element, hydrodynamic, squeeze film dampers, gears, etc.) to model assembly connections
- Symmetric or asymmetric rotor and stator can be computed, as well as multiple rotors with different rotation speeds and orientations
- Enable different analysis types: critical-speed analysis, harmonic-response analysis and transient analysis
- Dedicated postprocessing tools according to industrial standards

Capabilities chart

General capabilities	Specific capabilities	Simcenter 3D Response Dynamics	Simcenter 3D Noise and Vibration Modeling	Simcenter 3D Load Identification	Simcenter 3D NVH Composer	Simcenter 3D FE Model Correlation	Simcenter 3D FE Model Updating	Simcenter Nastran Dynamic Response	Simcenter Nastran Advanced Dynamics bundle	Simcenter Nastran DMP	Simcenter Nastran Rotor Dynamics	Simcenter Samcef Rotor bundle
		Structural dynamics										
Structural linear dynamics	Modal transient response	•						•	•			
	Modal frequency response	•						•	•			
	Direct transient response							•	•			
	Direct frequency response							•	•			
	Cyclic direct frequency response							•	•			
	Complex modal analysis							•	•			
	Shock spectrum	•						•	•			
	Random vibration	•						•	•			
Dynamic design analysis method	•						•	•				
Advanced dynamic analysis	Superelements								•			
	Coupled fluid-structure (vibro-acoustic) analysis							•	•			
	Frequency transfer functions (FRF)								•			
	Recursive domain normal modes (RDMODES)								•			
	Fast frequency response (FASTFR)							•	•			
	Direct matrix abstraction programming (DMAP)								•			
Aero-elasticity								•				
Parallel processing	Shared memory parallel (SMP)							•	•	•		
	Distributed memory parallel (DMP)								•	•		



General capabilities	Specific capabilities	Simcenter 3D Response Dynamics	Simcenter 3D Noise and Vibration Modeling	Simcenter 3D Load Identification	Simcenter 3D NVH Composer	Simcenter 3D FE Model Correlation	Simcenter 3D FE Model Updating	Simcenter Nastran Dynamic Response	Simcenter Nastran Advanced Dynamics bundle	Simcenter Nastran DMP	Simcenter Nastran Rotor Dynamics	Simcenter Samcef Rotor bundle
		Noise and vibration (NVH)										
NVH model creation	2D full vehicle topology definition from subassemblies				•							
	Full vehicle assembly automation				•							
	Bolt				•							
	Spring and bushing				•							
	Weatherstrip/sealing				•							
	Seam weld				•							
	Kinematic (e.g. latch and bumpstop)				•							
	Lumped mass trimming				•							
NVH post-processing	Modal contribution		•									
	Panel/grid contribution		•									
	Path contribution		•									
	Energy contribution		•									
System level NVH (hybrid)	Modal representations (modal coupling preprocessing)		•									
	FRF representations (FRF coupling preprocessing)		•									
	FRF analysis case		•									
Additional NVH	Transfer path analysis		•									
	Load identification analysis (mount method, inverse force)			•								
	Principal component analysis											
Rotor dynamics												
Rotor models	1D (line models), 2D, 3D models										•	•
	2D multi-harmonics models											•
	Mixed modeling representation											•
	Multiple rotors										•	•
	Cyclic symmetry											•
	Multi-stage cyclic symmetry											•
Symmetry and superelements	Symmetric rotor with symmetric stator										•	•
	Symmetric rotor with unsymmetric stator										•	•
	Unsymmetric rotor with symmetric stator										•	•
	Unsymmetric rotor with unsymmetric stator											•
	Superelement for the nonrotating parts										•	•
	Superelement for the rotating parts											•
Bearing models	Springs, dampers and bushings										•	•
	Linear bearings										•	•
	Hydrodynamic bearings											•
	Roller bar bearings											•
	Gears											•
	Magnetic bearings (digital controller)											•
	Squeeze film dampers											•
Dynamic rotor analysis	Campbell diagram and stability analysis										•	•
	Modal analysis (normal/complex)										•	•
	Harmonic response										•	•
	Linear transient response										•	•
	Nonlinear transient response											•
	Direct or modal computations										•	•

General capabilities	Specific capabilities	Simcenter 3D Response Dynamics	Simcenter 3D Noise and Vibration Modeling	Simcenter 3D Load Identification	Simcenter 3D NVH Composer	Simcenter 3D FE Model Correlation	Simcenter 3D FE Model Updating	Simcenter Nastran Dynamic Response	Simcenter Nastran Advanced Dynamics bundle	Simcenter Nastran DMP	Simcenter Nastran Rotor Dynamics	Simcenter Samcef Rotor bundle
Correlation												
Pretest and correlation	Pretest planning					•						
	Test model alignment and geometry mapping					•						
	Test-analysis, analysis-analysis correlation					•						
	Modal correlation (MAC, COMAC, X-orthogonality, etc.)					•						
	FRF correlation					•						
	Local coordinate systems					•						
	Mode pairing and visual comparison					•						
	Correlation with Simcenter Testlab					•						
Model updating	Design variable definition						•					
	Dedicated DESOPT 200 - model update solution						•					
	Design variable sensitivities							•				
	Frequency, mode shape (MAC and X-orthogonality)							•				
	Embedded eigenvalue solver							•				
	Multiple optimization algorithms							•				
	FEM and SIM update							•				
	Model updating for Simcenter Nastran							•				

Note: Simcenter 3D Engineering Desktop is a minimum prerequisite for all Simcenter 3D products. Other dependency or prerequisites may apply for individual products.

SIEMENS

Ingenuity for life

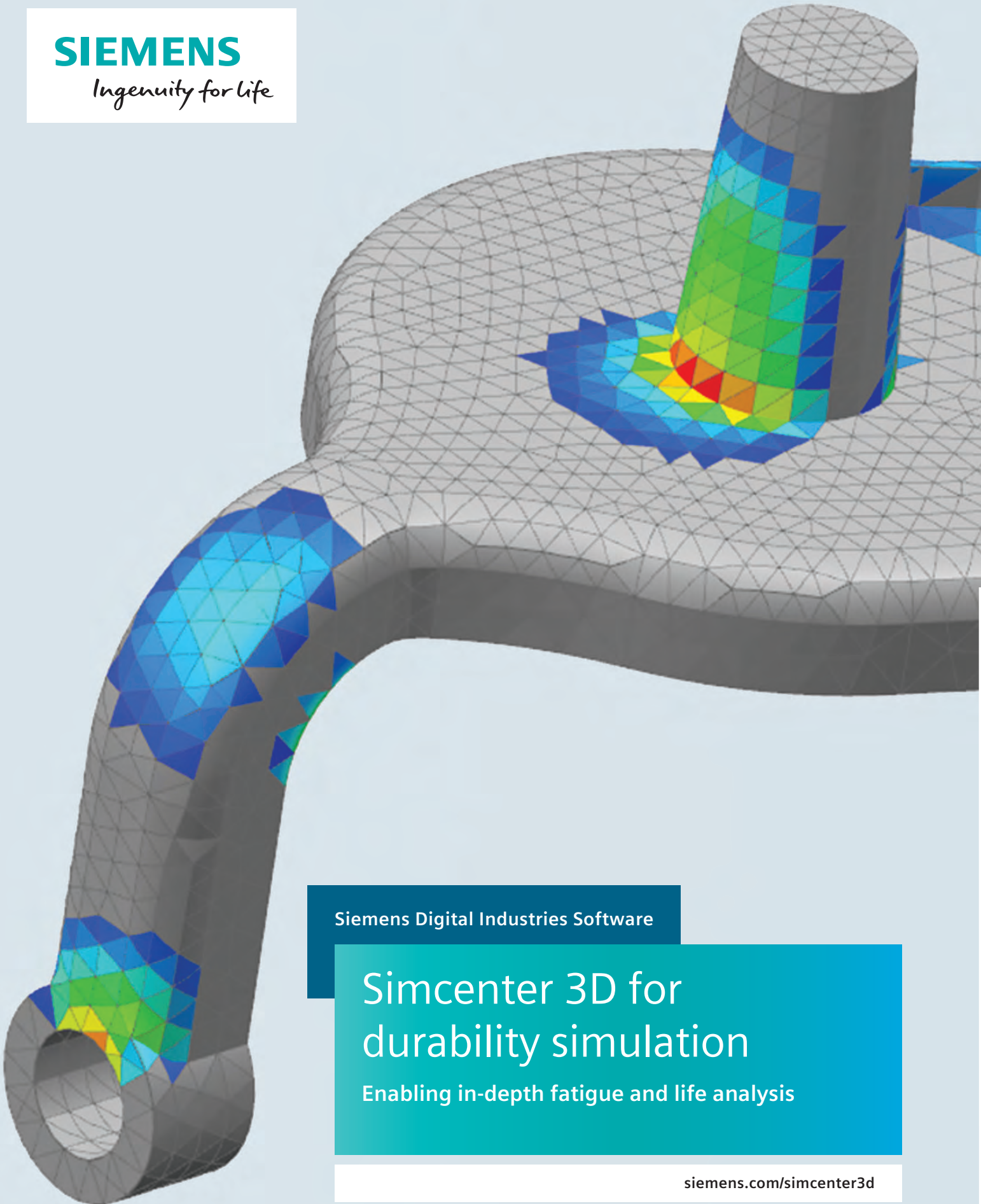

Siemens Digital Industries Software

Simcenter 3D for durability simulation

Enabling in-depth fatigue and life analysis

[siemens.com/simcenter3d](https://www.siemens.com/simcenter3d)

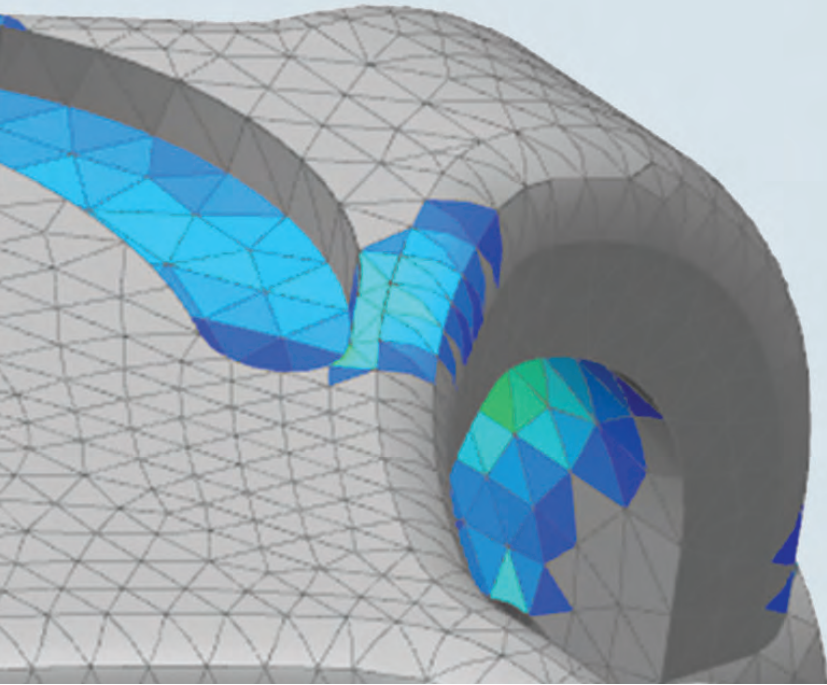

Solution benefits

- Explore multiple design options and optimize your design for strength and fatigue performance
- Perform fatigue life prediction analyses quickly and accurately accounting for realistic loading conditions
- Get insightful and rapid feedback on critical durability areas
- Simulate realistically the durability performance of complex connections and welded joints
- Predict component loads and optimize system level fatigue performance through load-transfer path approach
- Take advantage of the new materials and manufacturing processes using accurate fatigue methods

Simcenter™ 3D software offers a distinctive suite of tools to support fatigue design in all stages of development. This includes easy-to-use wizards for strength and fatigue in the design phase, fatigue information on the current simulated part, detailed analysis of complex load scenarios, including weldments and connections, and new materials and manufacturing processes.

The best way to predict a product's strength and durability

Shorter development cycles and ever-increasing quality requirements have stretched the test-based durability approach to the limits. Evaluating and refining the durability performance by simulation methods is the only valid alternative. The durability modules of Siemens Digital Industries Software's Simcenter 3D give you access to state-of-the-art analysis methods, enabling engineers to interactively assign loads to a model. The solution permits efficient analysis of seam and spot welds as well as new methodologies for composite materials.

Simcenter 3D for durability simulation

Eliminate over- or under-designed components

Analyze loads acting on the critical regions and improve the load flow from the application points that have the greatest influence on the critical areas, which is much better than just reinforcing around the critical area.

Enabling a more efficient and safe physical validation

Virtual test rig experiments facilitate the analysis of the impact of individual load events on component damage. Such analysis also permits the flexibility to define your specific load scenarios for each of the components, thereby saving testing time.

Include manufacturing and assembly aspects in durability analysis

New materials and manufacturing processes often have an important influence on fatigue behavior. With Simcenter 3D, one can take into account such manufacturing defects while performing durability analysis.

Design right the first time

To perform fatigue analysis in an efficient way, durability modules provide access to:

- Test data such as load data, test schedule definitions, etc.

- Simulation data, such as multibody results and finite element simulations of the digital twin
- State-of-the-art fatigue simulation methods
- Fatigue-specific postprocessing

Providing a platform for multidiscipline simulation

The Simcenter 3D durability solution is part of a larger, integrated multidiscipline simulation environment with the Simcenter 3D Engineering Desktop at the core for centralized pre-/postprocessing for all Simcenter 3D solutions. This integrated environment helps you to achieve faster CAE processes and streamline multidiscipline simulations that integrate durability and other disciplines like stress and strain from structural solutions, load prediction using motion solution and short or long-fiber composites nonlinear behavior prediction up to tight integration for damage tolerant design.

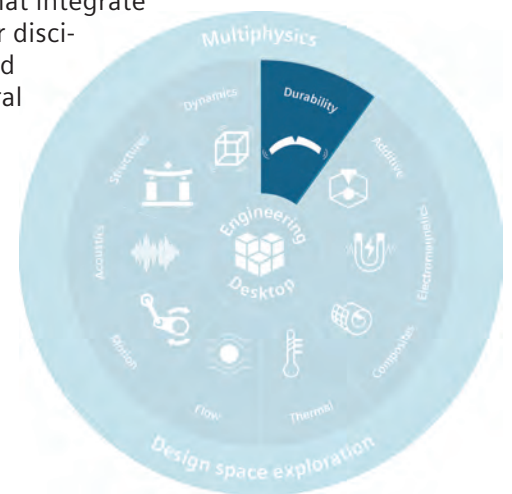

Loads	Create digital twin of test	Simulate test	In depth analysis																																																							
<p>Measure</p>	<p>Stress calculation</p>	<p>Apply material</p>	<p>If and where fatigue occur</p>																																																							
<p>Simulate</p>	<p>Load events Duty cycles</p> <table border="1"> <thead> <tr> <th>Event</th> <th>Start</th> <th>End</th> <th>Value</th> <th>Order</th> </tr> </thead> <tbody> <tr> <td>1</td> <td>0</td> <td>10</td> <td>100</td> <td>1</td> </tr> <tr> <td>2</td> <td>10</td> <td>20</td> <td>200</td> <td>2</td> </tr> <tr> <td>3</td> <td>20</td> <td>30</td> <td>300</td> <td>3</td> </tr> <tr> <td>4</td> <td>30</td> <td>40</td> <td>400</td> <td>4</td> </tr> <tr> <td>5</td> <td>40</td> <td>50</td> <td>500</td> <td>5</td> </tr> <tr> <td>6</td> <td>50</td> <td>60</td> <td>600</td> <td>6</td> </tr> <tr> <td>7</td> <td>60</td> <td>70</td> <td>700</td> <td>7</td> </tr> <tr> <td>8</td> <td>70</td> <td>80</td> <td>800</td> <td>8</td> </tr> <tr> <td>9</td> <td>80</td> <td>90</td> <td>900</td> <td>9</td> </tr> <tr> <td>10</td> <td>90</td> <td>100</td> <td>1000</td> <td>10</td> </tr> </tbody> </table>	Event	Start	End	Value	Order	1	0	10	100	1	2	10	20	200	2	3	20	30	300	3	4	30	40	400	4	5	40	50	500	5	6	50	60	600	6	7	60	70	700	7	8	70	80	800	8	9	80	90	900	9	10	90	100	1000	10	<p>Apply methods and parameters with one click</p>	<p>Why and when they occur</p>
Event	Start	End	Value	Order																																																						
1	0	10	100	1																																																						
2	10	20	200	2																																																						
3	20	30	300	3																																																						
4	30	40	400	4																																																						
5	40	50	500	5																																																						
6	50	60	600	6																																																						
7	60	70	700	7																																																						
8	70	80	800	8																																																						
9	80	90	900	9																																																						
10	90	100	1000	10																																																						

Industry applications

Aerospace and defense

Simcenter 3D is used to predict mechanical system fatigue life for landing gears, control mechanisms, slat tracks and other critical assemblies. Local stress concentrations are identified based on all possible combinations of local load conditions to address durability problems long before prototypes are built. A wide range of methods can localize weak spots and assess fatigue life.

Automotive and transportation

Simcenter 3D is used to execute fatigue-life assessments on body frames, panels, cross-members and door systems as well as on sunroofs, latches and locking systems. The Simcenter 3D Durability module also enables a high degree of accuracy for specific seam and spot weld analyses. Advanced numerical durability predictions can be applied to engines, powertrain parts, engine brackets, gear box chain heels and exhaust lines.

Industrial machinery

In industrial applications, achieving cost efficiencies depends on critical parts that are typically subjected to large dynamic multiaxial load cases. Any metal component subjected to dynamic loading cycles can be efficiently optimized. Simcenter 3D Durability can be used to determine rotor base fatigue life in large rotating machines.

Marine

Simcenter 3D Specialist Durability connection modeling allows you to have a digital twin for kilometers of welds performed in ship structures. For high-end yachts with lots of composite materials, the Simcenter 3D Specialist Durability Composite Fatigue module facilitates state-of-the-art analysis.

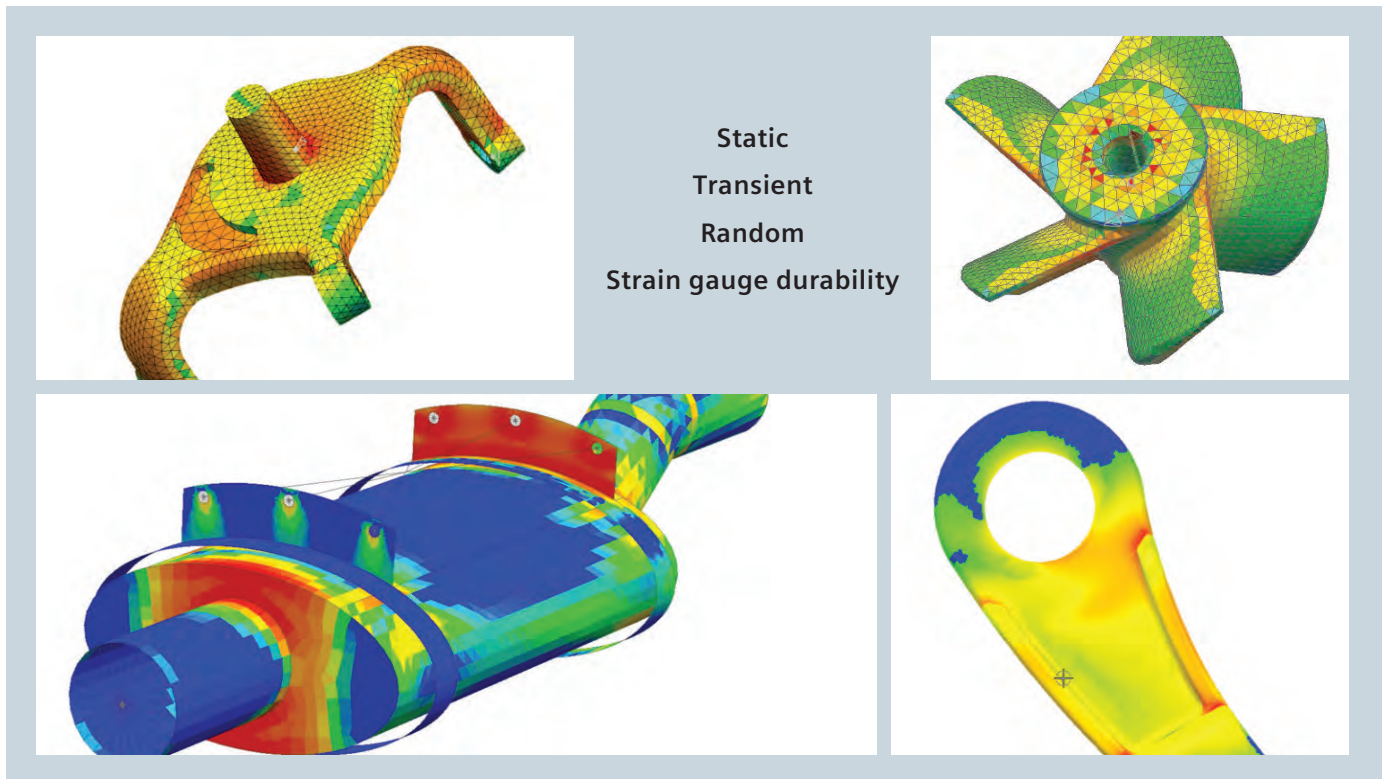

Simcenter 3D Durability wizard

Simcenter 3D Durability wizard is a simulation wizard for calculating the fatigue life of mechanical components subjected to cycles of loading. This solution is performed after users have calculated a stress state from static loading using a finite element (FE) solver. The durability algorithms in the wizard are based on the crack initiation method for fatigue analysis.

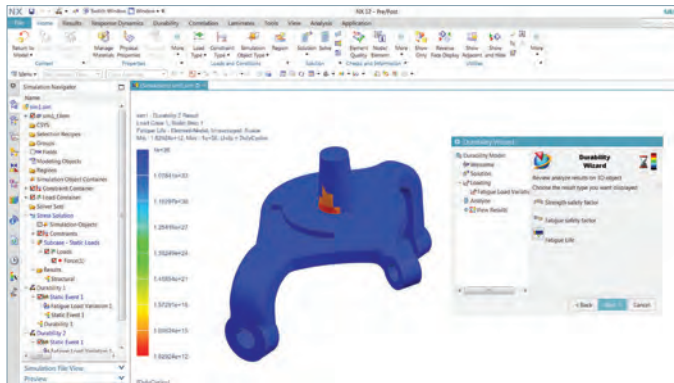
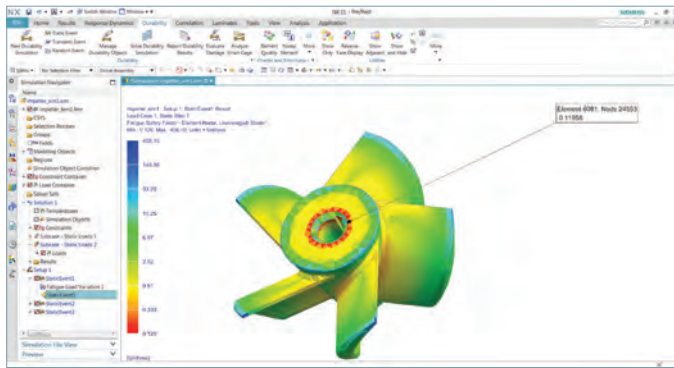

Module benefits

- Improves robustness by predicting the life of product designs and determining which design features are over- or under designed
- Reduces physical testing costs by allowing you to analyze product life in a virtual environment
- Accelerates product design by allowing designers to quickly perform what-if reanalysis of new designs
- Understand the impact of changes to product durability

Key features

- Use linear stress or strain results in static solutions with NX™ software stress wizard, Simcenter Nastran® software, MSC Nastran, Abaqus and ANSYS
- Define the cyclic loadings that define the duty cycle of the part over its lifetime
- Compute static safety factors, fatigue safety factors and fatigue life
- Available fatigue criterion: Smith-Watson-Topper, strain or stress life
- Display contour plots for strength safety factor, fatigue safety factor or fatigue life
- Prepare a technical durability report

Durability 2			
Fatigue Load Variations			
Load Variation	Number of Cycles	Scaling Factor	Scaling Function
1	7000		7,000000 Full Unit Cycle
Fatigue Analysis Options			
Evaluation Type: Ultimate			
Stress Safety Factors: Von_Mises			
Number of Fatigue Duty Cycles: 1e+20			
Fatigue Safety Factors: Fatigue Strength Factor: 1			
Fatigue Life: Smith_Watson_Topper			
Results			
Coordinate System: Absolute Rectangular			
Number of LoadCases: 1			
Load Case 1: Number of Iterations = 1			
Iteration	Strength Safety Factor(Unitless)	Fatigue Safety Factor(Unitless)	Fatigue Life(DutyCycles)
10	1.18E+05	4.86E+03	1.00E+16
20	1.60E+01	2.09E-01	1.45E+14
21			

Simcenter 3D Advanced Durability

Simcenter 3D Advanced Durability software helps to validate product's structural integrity over its lifecycle under either simple or complex loading conditions. Expert analysts use this solution to perform in-depth fatigue analysis and life calculations to help them determine product durability based on Simcenter Nastran, Simcenter 3D Response Dynamics, MSC Nastran, ANSYS and Abaqus solutions. Based on the crack initiation method for fatigue calculation, the user has a choice of multiple life criteria and can account for mean stress effects, notch effects, hardening effects and biaxial stress effects. Fatigue and strength safety factors, fatigue life and damage results are viewable as contour plots.

Module benefits

- Save time with what-if redesigns
- Improves product design robustness by determining the life of product designs
- Reduces physical testing costs by enabling you to analyze product life in a virtual environment

Key features

- Simcenter 3D integration leverages geometry associativity to quickly evaluate the impact of changing geometrical features on durability
- Industry standard life criteria, stress direction approaches, mean stress effects, notch effects, cyclic stress-strain relations and rainflow cycle counting
- Static, transient (including flexible body) and random events
- Strain gauge durability

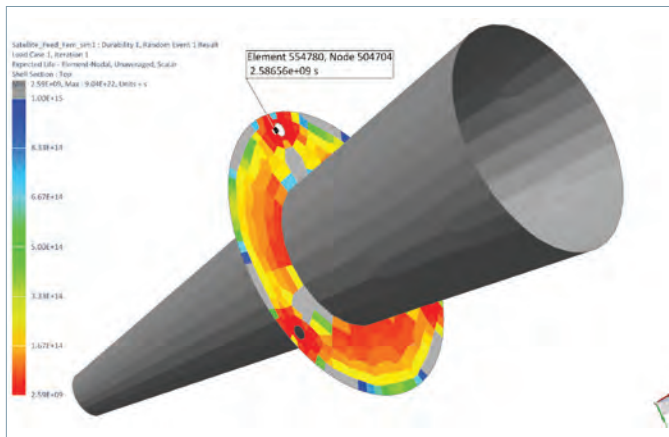

Simcenter 3D Specialist Durability Modeling

Simcenter 3D Specialist Durability Modeling provides a rich and intuitive tool set to prepare solutions, send them to the solver and postprocess durability results. It enables the setup of complex durability scenarios with many finite element and load history cases. Durability solutions may be configured using the provided parameters or configured to follow the standard procedures of the user.

Module benefits

- Intuitive and flexible parameter-based setup
- Quickly isolate fatigue-critical locations and load cases under complex duty cycles
- Understand the cause of fatigue problems

Key features

- Parameter-driven analysis types, solver profiles and durability simulation objects
- Direct component-load importing from prototype measurements or Simcenter 3D multibody simulation and third-party, time-data formats
- Integration with Simcenter Testlab™ software load-data processing tools for durability load-case selection
- Assign complex duty cycles to assemblies and their connections, including seam and spot welds
- Dedicated 2D and 3D postprocessing scenarios

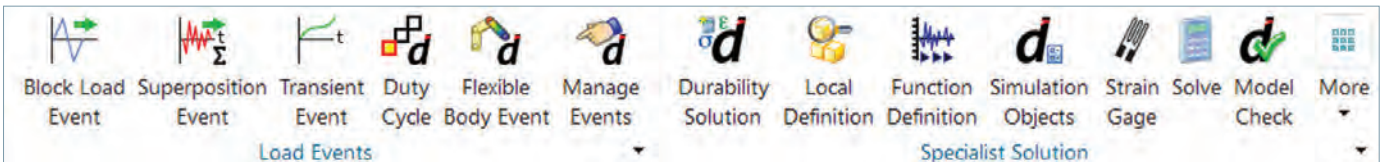
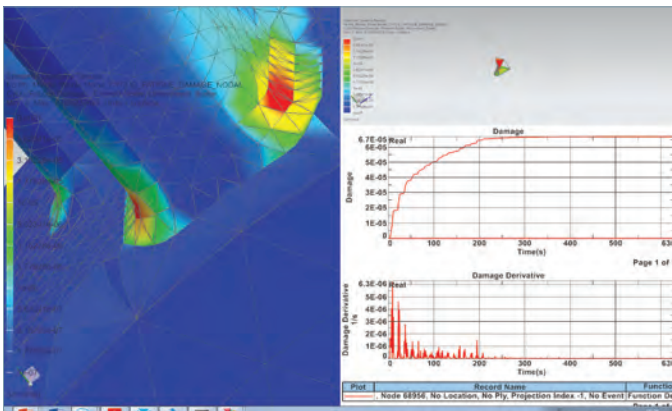

Index	Load History	Data Source	Index	Subcase
1	WHEEL@-X	MBS_Forces	1	DURABILITY KNUCKLE: CONTROL ARM: STEER-X
2	WHEEL@-Y	MBS_Forces	2	DURABILITY KNUCKLE: CONTROL ARM: STEER-Y
3	WHEEL@-Z	MBS_Forces	3	DURABILITY KNUCKLE: CONTROL ARM: STEER-Z
4	WHEEL@-RX	MBS_Forces	4	DURABILITY KNUCKLE: CONTROL ARM: LCA-X
5	WHEEL@-RY	MBS_Forces	5	DURABILITY KNUCKLE: CONTROL ARM: LCA-Y
6	UCA@-X	MBS_Forces	6	DURABILITY KNUCKLE: CONTROL ARM: LCA-Z
7	UCA@-Y	MBS_Forces	7	DURABILITY KNUCKLE: CONTROL ARM: UCA-X
8	UCA@-Z	MBS_Forces	8	DURABILITY KNUCKLE: CONTROL ARM: UCA-Y
9	STEER@-X	MBS_Forces	9	DURABILITY KNUCKLE: CONTROL ARM: UCA-Z
10	STEER@-Y	MBS_Forces		

#	Load	Load History	Data Source	Subcase	Subcase
9	STEER@-X		MBS_Forces	1	DURABILITY KNUCKLE: CONTROL ARM: STEER-X
10	STEER@-Y		MBS_Forces	2	DURABILITY KNUCKLE: CONTROL ARM: STEER-Y
11	STEER@-Z		MBS_Forces	3	DURABILITY KNUCKLE: CONTROL ARM: STEER-Z
12	LCA@-X		MBS_Forces	4	DURABILITY KNUCKLE: CONTROL ARM: LCA-X
13	LCA@-Y		MBS_Forces	5	DURABILITY KNUCKLE: CONTROL ARM: LCA-Y
14	LCA@-Z		MBS_Forces	6	DURABILITY KNUCKLE: CONTROL ARM: LCA-Z
7	UCA@-X		MBS_Forces	7	DURABILITY KNUCKLE: CONTROL ARM: UCA-X
8	UCA@-Y		MBS_Forces	8	DURABILITY KNUCKLE: CONTROL ARM: UCA-Y
8	UCA@-Z		MBS_Forces	9	DURABILITY KNUCKLE: CONTROL ARM: UCA-Z

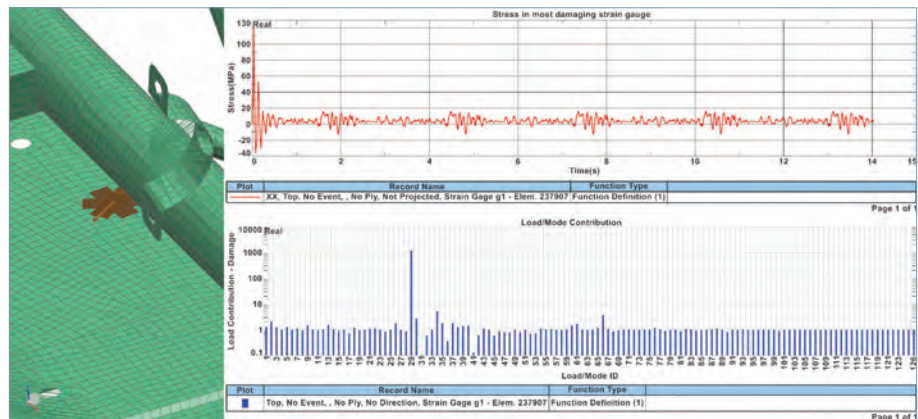

Simcenter 3D Specialist Durability solver

Using Simcenter 3D Specialist Durability solver is the basic solver for specialist fatigue analysis. It may be run on the same computer or independently in batch mode. It provides all standard durability methodologies but may easily be extended with any fatigue methodology due to unique openness via user-defined fatigue methods.

Module benefits

- Reduce fatigue analysis time
- Quick and accurate fatigue-life predictions based on realistic loading conditions
- Explore multiple design options and optimize the design for fatigue performance

Key features

- Industry standard fatigue-life solver with proven accuracy and speed
- Parallel processing enabled with the standard license
- All industry standard methods
- New and unique user defined methods interface
- Batch processing

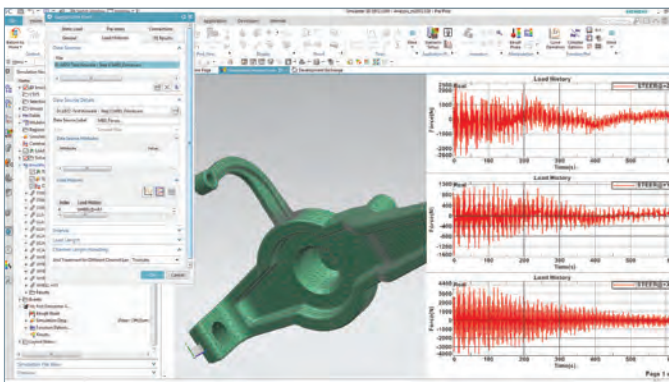

Simcenter 3D Specialist Durability Composite Fatigue

Simcenter 3D Specialist Durability Composite Fatigue provides a unique methodology for analyzing short and continuous-fiber composites. It can incorporate stiffness reduction and stress redistribution during the fatigue life of composites under complex load situations. New technologies reduce the effort it takes to test for parametrization of the methods.

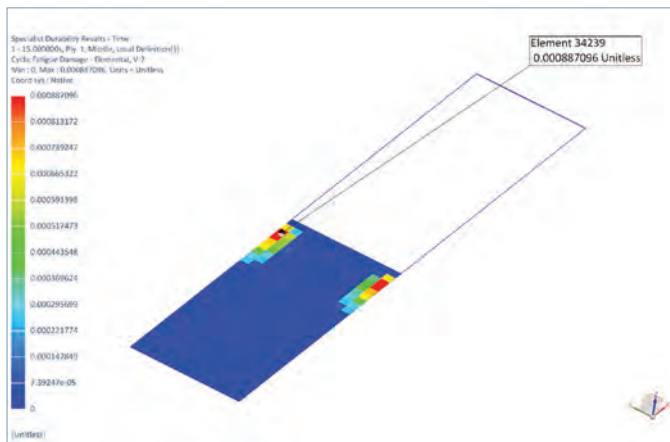

Module benefits

- Know the real progressive damage behavior of your composite material
- Allows damage-tolerant design
- Ability to predict fatigue damage to composite material
- Defined parameter identification processes available

Key features

- Unique workflow that enables stiffness reduction and stress redistribution
- Variable amplitude and multiaxial loads
- Ply-based fatigue behavior modeled with no tests on full stacking needed
- Master SN-curve approach for arbitrary short-fiber orientations
- Intra- and Interlaminar methods for continuous-fiber composites
- Integrated with continuous damage models and analysis with Simcenter Samcef® software solvers
- User-defined methods, including stiffness reduction and stress redistribution

Simcenter 3D Specialist Durability for Connections

Simcenter 3D Specialist Durability for connections allows you to set up and conduct special spot weld and seam weld analysis runs. Welds are taken from connections modeled in Simcenter 3D, defined in the xMCF format, or detected in existing meshes. The load setup and analysis are conducted with the same tools from Simcenter 3D Specialist Durability Modeling and may even be mixed in one analysis case.

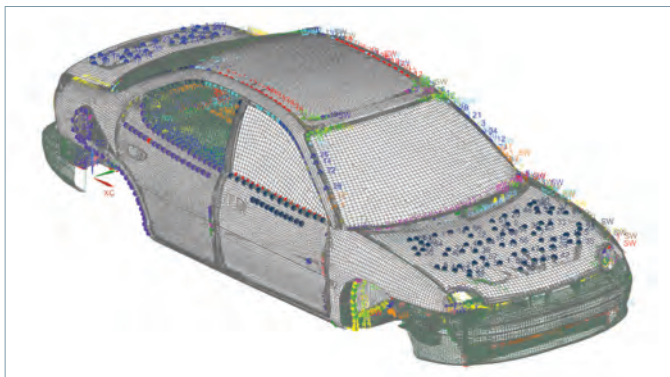
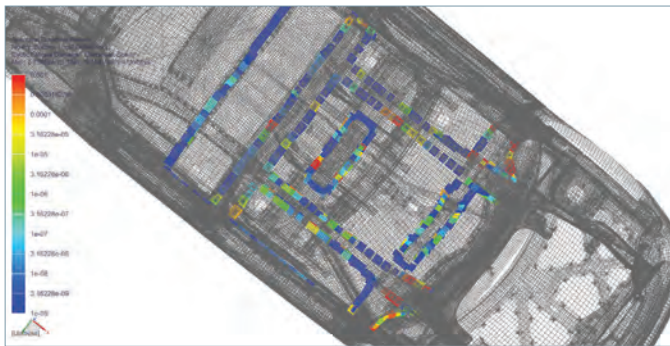
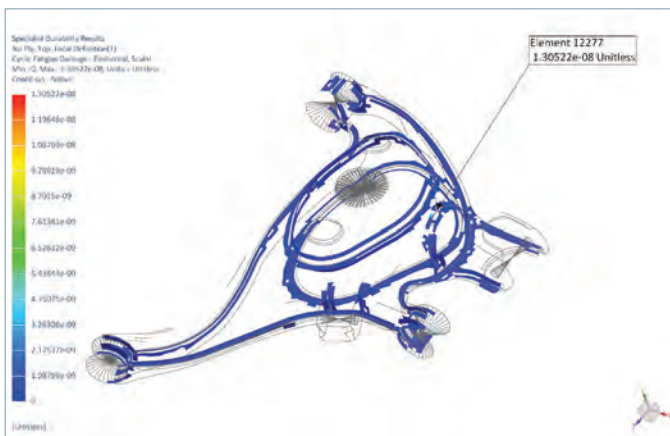

Module benefits

- Comprehensive software to predict fatigue of seam and spot welds under arbitrary loading conditions
- Provides most accurate prediction of seam welds fatigue life without remodeling
- Increases engineers' throughput by enabling automatic detection of weld topologies
- Powerful software to handle welded assemblies irrespective of size and number of welds
- Efficiently handles both traditional approaches and most accurate approaches on the same model
- Validate more weld variants and its fatigue life within shorter development cycles
- Understand and improve fatigue testing for seam-welded assemblies

Key features

- Innovatively designed algorithms: Automatic detection of welds and weld geometry from FE models and groups based on joint types, penetration grade and sheet thickness
- Support industry typical FE connection modeling for seam and spot welds
- Handles all load cases: transient, random, harmonic, proportional and non-proportional and schedules
- Special tools for seam welds: Mesh independent notch stress method (R1MS, R03MS, R005MS), including notch effects (effective notch stress method) using the microstructural length p^*
- User-defined methodologies can access all weld data

Capabilities chart

General capabilities	Specific capabilities	Simcenter 3D Durability Wizard	Simcenter3D Advanced Durability	Simcenter 3D Specialist Durability Modeling	Simcenter 3D Specialist Durability solver	Simcenter 3D Specialist Durability Composite Fatigue	Simcenter 3D Specialist Durability for Connections
Loads and stresses	Loads from Simcenter Testlab			•	•	•	•
	Loads from industry test formats (IST, MSC, EDAS,...)			•	•	•	•
	Loads from Simcenter 3D Motion		•	•	•	•	•
	Finite element results (Simcenter Nastran, Simcenter Samcef, ABAQUS, ANSYS, universal format)	•	•	•	•	•	•
	Block load events	•	•	•	•	•	•
	Superposition events (unlimited number of loadcases, automatic matching)			•	•	•	•
	Transient events (editor to select increments, change order, invert ordering)		•	•	•	•	•
	Pre-stress and static load cases		•	•	•	•	•
	Flexible event (directly analyse Simcenter3D Motion Flexible Body)			•	•	•	•
	Duty cycle events			•	•	•	•
	Duty cycles from spreadsheets			•			
	Random vibration loads		•	•	•		•
Materials	Simcenter3D material database	•	•	•	•	•	•
	Generation of material set based on existing material data (UML, universal slope, ...)			•			
	Material individually assigned to selection and groups	•	•	•			
	Weld standard data (IIW, Eurocode, BS, ...)		•	•			
	Durability databases		•	•			
Setup	Directly from finite element calculation	•	•	•			
	Inherit or overwrite materials	•	•	•			
	Parameter databases			•			
	User defined analysis types - define methods and parameters in one selection			•			
Fatigue methods and solver	High cycle fatigue – stress-life	•	•	•	•		
	Low cycle fatigue – strain-life	•	•	•	•		
	Infinite life – safety factor / margin of safety	•	•	•	•		
	User defined fatigue methods			•	•		
	Structural stress seam weld analysis		•				•
	Notch stress seam weld analysis (incl notch severity)						•
	Stress based spot weld analysis						•
	Force based spot weld analysis						•
	User defined weld methods						•
	Multiple mean stress influence methods		•	•	•	•	•
	Multiaxial fatigue		•	•	•	•	•
	Notch/size effects – stress gradient correction		•	•	•	•	•
	Localized parameters (material/parameter map)			•	•		
	Fatigue below surface method			•	•		
	Use material data for user defined probability of survival			•	•		•
	Multiple damage accumulation rules (linear)		•	•	•	•	
Short-fiber reinforced composites (master SN-curve approach)					•		

General capabilities	Specific capabilities	Simcenter 3D Durability Wizard	Simcenter3D Advanced Durability	Simcenter 3D Specialist Durability Modeling	Simcenter 3D Specialist Durability solver	Simcenter 3D Specialist Durability Composite Fatigue	Simcenter 3D Specialist Durability for Connections
Fatigue methods and solver (continued)	Intra-ply fatigue of endless-fiber composites (unidirectional/woven. etc)		•			•	
	Inter-ply fatigue of endless-fiber composites (unidirectional/woven. etc)					•	
	Automatic iteration of FE runs to account for global stiffness changes					•	
	Arbitrary damage accumulation					•	
	User defined damage rules for composites					•	
	Parallel processing (local and on external machines)				•	•	•
	Different methods (e.g. stress-life and weld) on different locations(groups) in one analysis			•	•	•	•
	Different methods (e.g.different parameters) on one group in one analysis				•	•	•
Postprocessing	Damage/lifetime	•	•	•	•	•	•
	Detailed analysis of stress (max/min/max amplitude, mean)		•	•	•	•	•
	Mileage/Real lifetime				•	•	•
	Design life factors				•	•	•
	Safety factors	•	•	•	•	•	•
	Individual for groups		•	•			
	Individual for events of duty cycles			•			
	For intermediate time steps			•		•	
	Hot spot detection			•			
	Detailed function analysis on strain gauge and individual nodes/elements			•	•		
	Function analysis on all critical planes				•		
	Damage accumulation time histories				•		
Load contribution analysis				•			

Legend:

• = included in module

Note: Simcenter 3D Engineering Desktop is a minimum prerequisite for all Simcenter 3D products. Other dependency or prerequisites may apply for individual products.

SIEMENS

Ingenuity for life

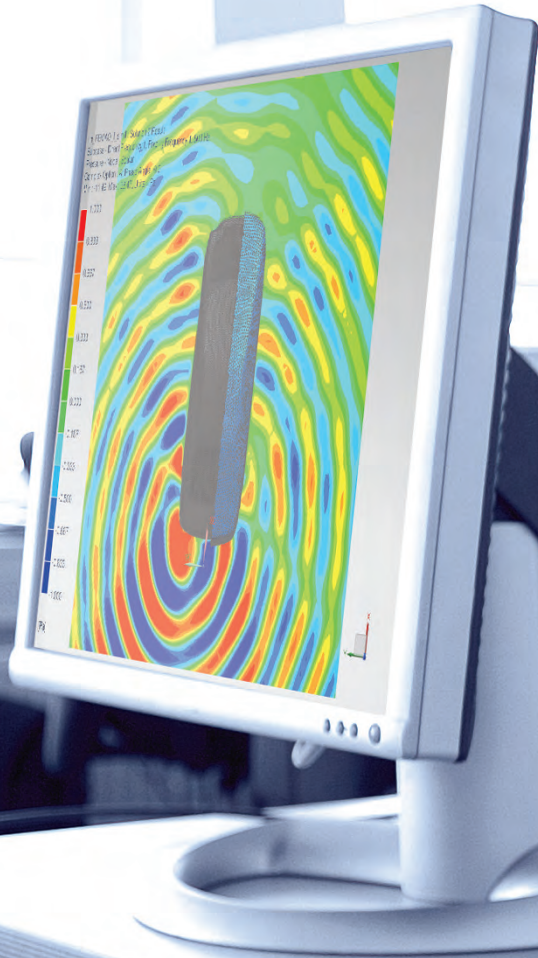

Siemens Digital Industries Software

Simcenter 3D for acoustics simulation

Optimizing the sound quality of products

[siemens.com/simcenter3d](https://www.siemens.com/simcenter3d)

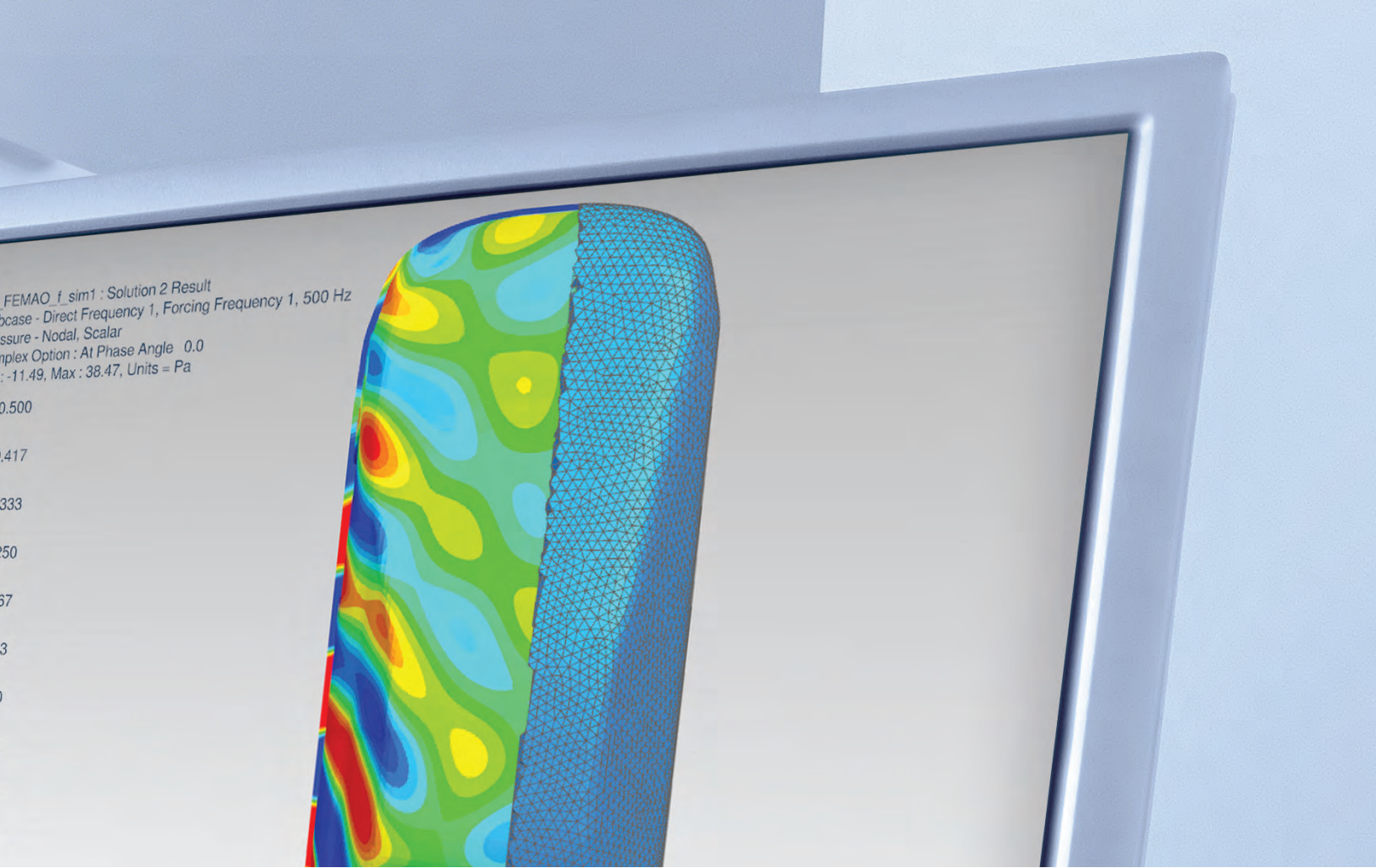

FEMAO_f_sim1 : Solution 2 Result
Case - Direct Frequency 1, Forcing Frequency 1, 500 Hz
Pressure - Nodal, Scalar
Complex Option : At Phase Angle 0.0
Min : -11.49, Max : 38.47, Units = Pa

Solution benefits

- Accelerate creation of acoustic simulation model from complex geometries, either from structural mesh model, CAD geometry or from scratch
- Use fast and efficient FEM/BEM solvers to more rapidly deliver acoustic computations
- Efficiently solve acoustics, vibro-acoustics and flow-induced noise problems from a single interface
- Simulate acoustic performance for interior, exterior or mixed interior-exterior problems
- Speed up multiple RPM acoustic computations involving engines, gearboxes and rotating components
- Perform realistic acoustic simulation: anechoic boundary condition, porous (rigid and limp frames) trim materials, acoustic source and more

Simcenter™ 3D software offers a comprehensive solution to minimize noise and optimize the sound quality of products. Dedicated acoustic modeling capabilities, efficient solvers and easy-to-interpret visualization tools allow you to quickly gain insight into a design's acoustic performance for uncoupled acoustics, coupled vibro-acoustics and aero-acoustic applications.

Accelerate acoustic meshing and modeling

Advanced features, such as surface wrapping, convex meshing, mesh thickening and the ability to create hybrid (hexa-tetra) meshes, help you accelerate acoustic meshing processes more than traditional preprocessors. The availability of various material models for both structure and fluid and the wide variety of structural and acoustic boundary conditions and loads allow you to efficiently set up your analysis.

Deliver high-fidelity vibro-acoustic simulations in the most efficient way

Simcenter 3D increases the realism in your simulations by providing support for loads or source creation from test data and predecessor multi-body or computational fluid dynamics (CFD) simulations. Simcenter Nastran®

Simcenter 3D for acoustics simulation

software is used to rapidly solve complex interior and exterior acoustics problems thanks to key features like automatically matched layer (AML) and finite element adaptive order (FEMAO) technology, which allow you to use small fluid meshes with an optimal number of degrees-of-freedom (DOF) per frequency.

Faster design-analysis iterations with CAD-CAE-test associativity

Simcenter 3D seamlessly links to computer-aided design (CAD), computer-aided engineering (CAE) and even test data. Any design modification can be easily introduced to the structural and/or acoustic model, eliminating multiple conversions between file formats and recreating models.

Gain instantaneous insight with acoustic-specific postprocessing

Simcenter 3D provides easy-to-interpret and intuitive postprocessing tools to investigate noise as sound pressure level (SPL), acoustic power or directivity. Path, modal and panel contribution analysis helps to rapidly identify the important noise sources and their propagation.

Providing a platform for multidiscipline simulation

The Simcenter 3D acoustics solution is part of a larger, integrated multidiscipline simulation environment with the Simcenter 3D Engineering Desktop at the core for centralized pre- and postprocessing for all Simcenter 3D solutions. This integrated environment helps you to achieve faster CAE processes and streamline multidiscipline simulations that integrate acoustics and other disciplines like, gear whine analysis from motion solutions, or NVH and vibro-acoustics analyses that require structural or flow-induced loads.

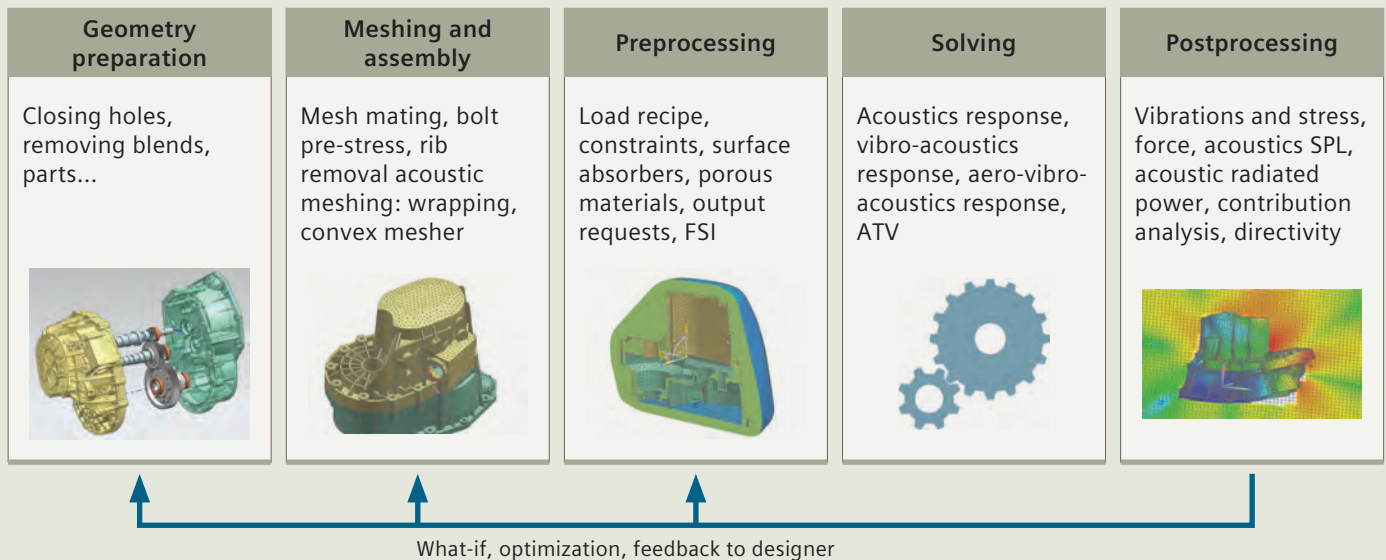
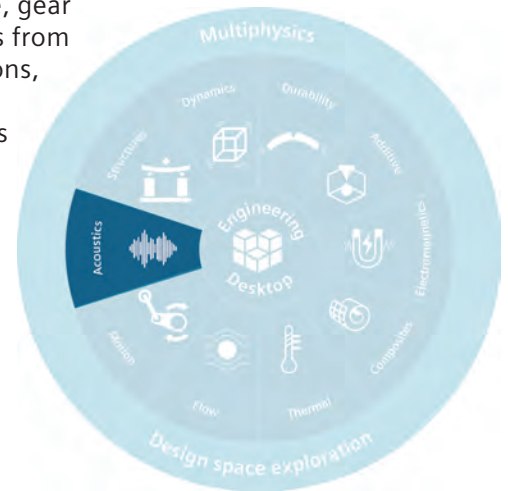

Industry applications

Since noise can impact health, and a quiet product is often perceived as higher in quality, companies are adopting efficient processes and tools to optimize the noise performance of their products.

Aerospace and defense

With Simcenter 3D, aviation engineers can predict cabin noise generated by turbulent boundary layers (TBL) on the fuselage or by aero-acoustic noise coming from the environmental control system (ECS). Exterior noise can be tackled using high-end boundary element method (BEM) and FEM solvers. Spacecraft engineers can reduce the risk of their acoustic verification tests by evaluating them virtually in Simcenter 3D.

Automotive and transportation

During vehicle development and improvement programs, the capabilities of Simcenter 3D can deliver noise, vibration and harshness (NVH) engineers with valuable insight into acoustic, vibro-acoustics and aero-acoustic noise contributions in the vehicle cabin and exterior environment.

Consumer goods

Building powerful, high-quality speakers, silent vacuum cleaners and washing machines and other noise-free consumer goods requires advanced noise engineering and sound characterization features provided by Simcenter 3D.

Industrial machinery

Simcenter 3D acoustic modules provide the necessary features to evaluate machine-radiated noise, including capturing the effect of encapsulations with sound treatments.

Marine

Acoustic features of Simcenter 3D can be used to study complex underwater radiation from ship hulls, propellers and submarine hull reflections of sonar waves.

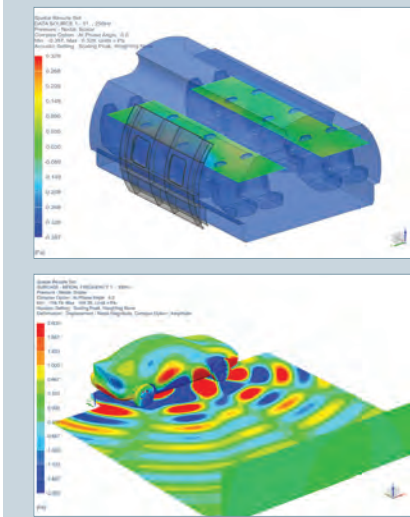
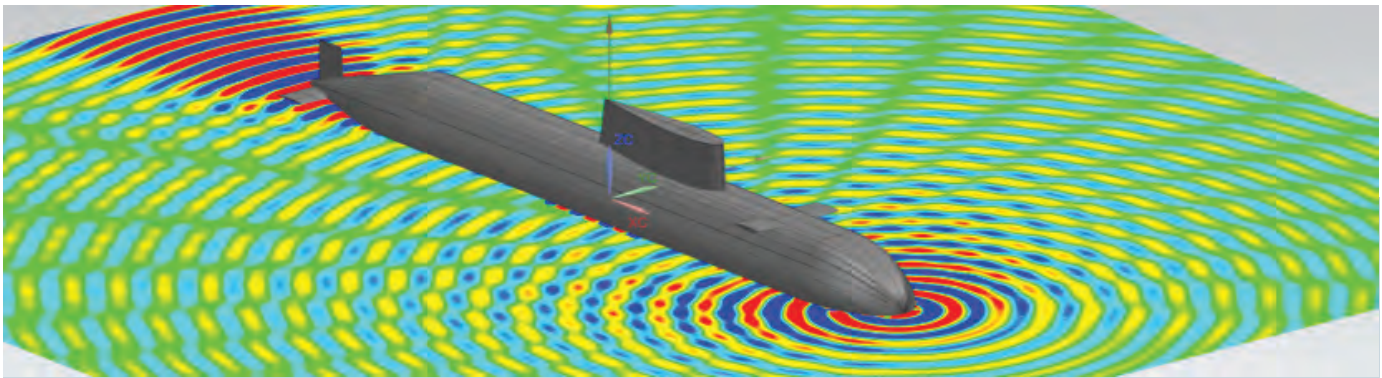

- Structural acoustics
- Aero-vibro-acoustics
- Component noise radiation
- Full vehicle scattering
- Cabin vibro-acoustics
- Transmission loss
- FEM / BEM

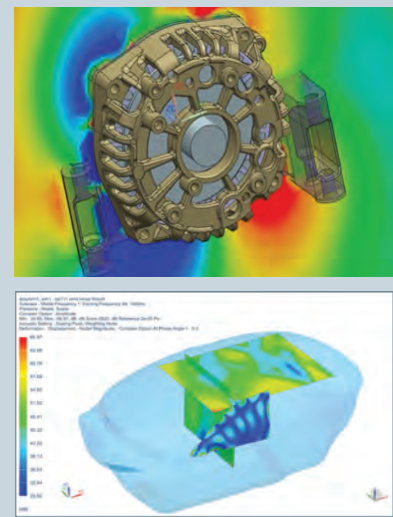



Simcenter 3D Meshing for Acoustics

Simcenter 3D Meshing for Acoustics software helps you create meshes for FEM and BEM acoustic analysis. The module provides user-friendly, leading-edge functionalities to create an acoustic fluid mesh, both for interior as well as exterior acoustic applications, starting from an existing structural mesh or CAD geometry.

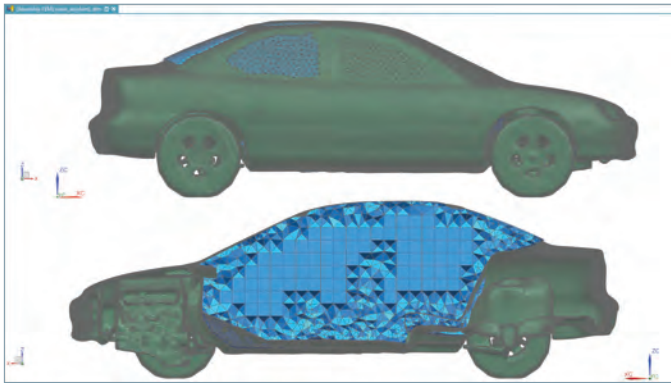

Module benefits

- Start from a structural FEM model or CAD geometry
- Accelerate the acoustic meshing process for complex geometries

Key features

- Hybrid mesh and polygon-based coarsening, hole-filling and rib-removal tools
- Interior and exterior surface-wrapping technology based on input of CAD or CAE model
- Easy creation of convex outer boundary surface to construct FEM meshes for exterior acoustics
- Hybrid hex a dominant hexa and tetra mesher for fluid volumes facilitating efficient solving
- Shell mesh thickening (reverse of mid-surfacing) to derive the boundary surfaces of fluid cavities, which is useful for muffler and other fluid FEM meshes

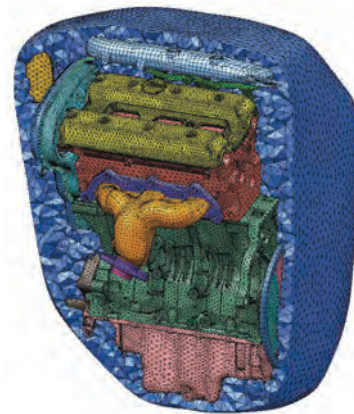

Simcenter Nastran Advanced Acoustics

Simcenter Nastran Advanced Acoustics software provides support for standard loads and boundary conditions, and key technologies like AML and FEMAO, to rapidly resolve acoustic simulations. It is well suited to study the acoustic radiation of components and pass-by noise of full vehicles, transmission loss of duct systems like intakes and exhausts or mufflers, and transmission loss of panels.

Module benefits

- Performs vibro-acoustic (SOL108/SOL111) simulations for interior or exterior noise
- Study exterior acoustics with lean FEM models thanks to embedded AML technology
- Efficiently simulate broadband acoustic problems using the adaptive FEMAO solver

Key features

- Support standard loads and boundary conditions, as well as specific acoustic boundary conditions like duct modes and acoustic diffuse field (random) loads
- Pressure loads on structural surfaces from other acoustic or CFD analysis
- Porous and temperature-dependent fluid materials, frequency-dependent surface impedance and transfer admittance between pairs of surfaces
- Compute sound pressure, intensity and power for virtual microphones located inside or outside the meshed fluid volume

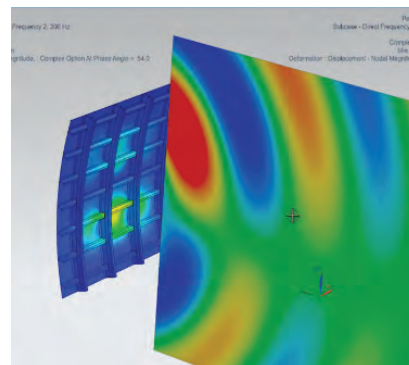
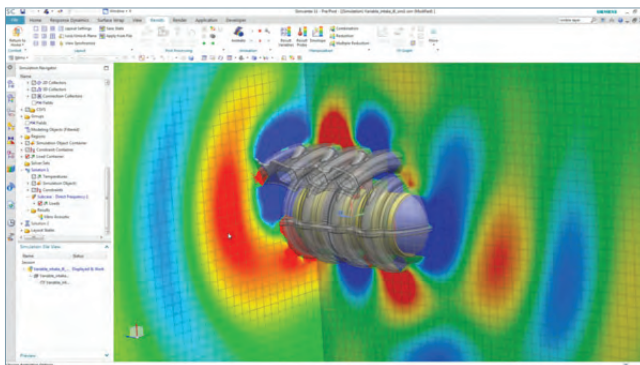
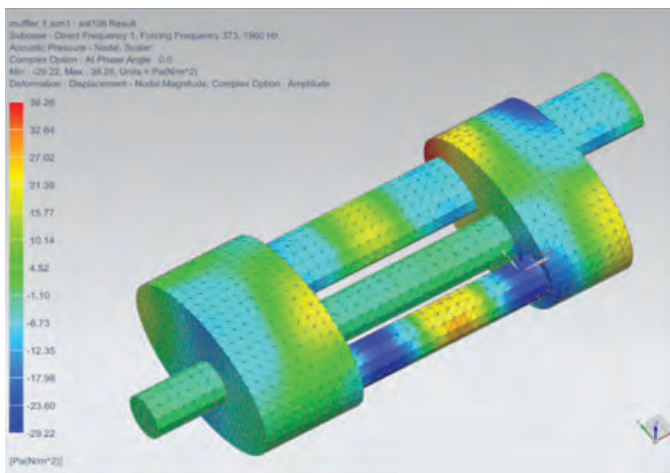

Simcenter 3D Acoustic Transfer Vector

Simcenter 3D Acoustic Transfer Vector software supports computing the acoustic transfer vector (ATV), expressing the sensitivity of the pressure response at a virtual microphone per-unit normal velocity at field points on a radiating surface. It can be re-used to quickly predict the acoustic response for any surface vibrations. Similarly, vibro-acoustic transfer vectors (VATV) express the sensitivity of microphone pressures for unit force applied at points on a structure. Also, VATV can be quickly re-used for predicting the acoustic response to any force loading.

Module benefits

- Use ATV to compute noise from rotating machines with multiple revolutions per minute (RPM) loads up to 100 times faster
- Use VATV to quickly evaluate cabin noise due to multiple load cases of flow-induced pressure loads, like wind loads and turbulent boundary layers

Key features

- ATV and VATV results are stored efficiently in a Nastran (op2) result file
- ATV can be interpolated when used in a forced response context
- Evaluate acoustic pressure and power and panel, grid and modal contributions for ATV response

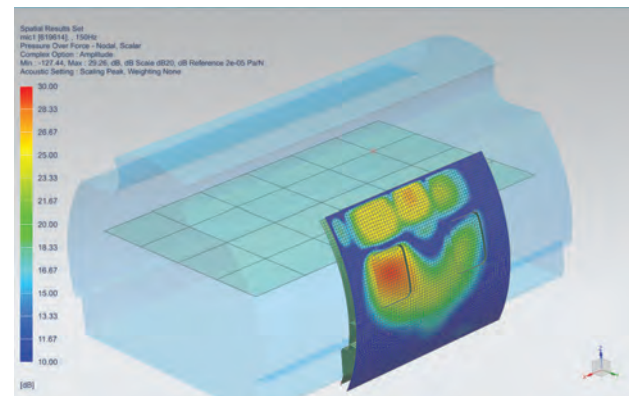
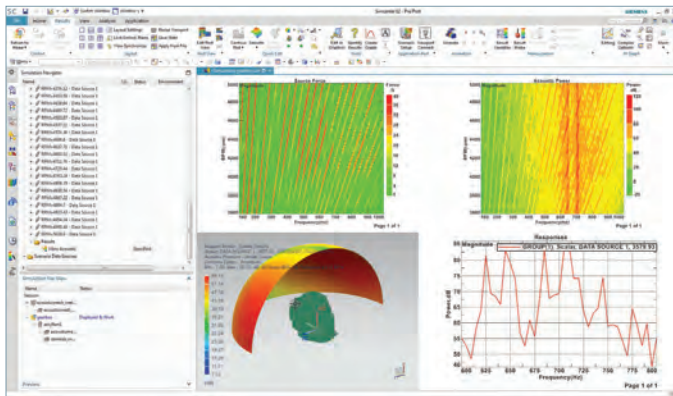

Simcenter 3D Aero-Vibro-Acoustics

Simcenter 3D Aero-Vibro-Acoustics software supports creating aero-acoustic sources close to noise-emitting turbulent flows and allows you to compute their acoustic response in the exterior or interior environment; for example, for noise from heating, ventilation and air conditioning (HVAC) and environmental control system (ECS) ducts, train boogies and pantographs, cooling fans, ship and aircraft propellers and more. The product also allows you to define wind loads acting on structural panels, leading to a vibro-acoustic response; for instance, in a car or aircraft cabin.

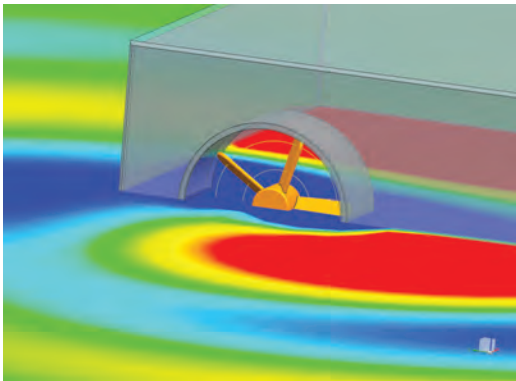
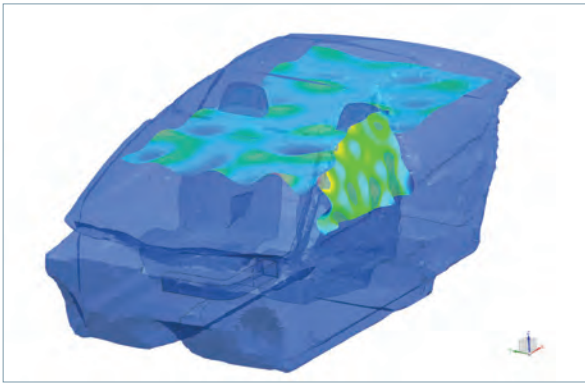

Module benefits

- Derive lean, surface pressure-based aero-acoustic sources for stationary and rotating surfaces
- Provide scalable and user-friendly load preparation for aero-vibro-acoustic wind noise simulations
- Import binary files with load data directly in Simcenter Nastran for response computation

Key features

- Conservative mapping of pressure results from CFD to the acoustic or structural mesh
- Equivalent aero-acoustic surface dipole sources
- Equivalent aero-acoustic fan sources for both tonal and broadband noise
- Wind loads, using either semi-empirical turbulent boundary layer models or mapped pressure loads from CFD results

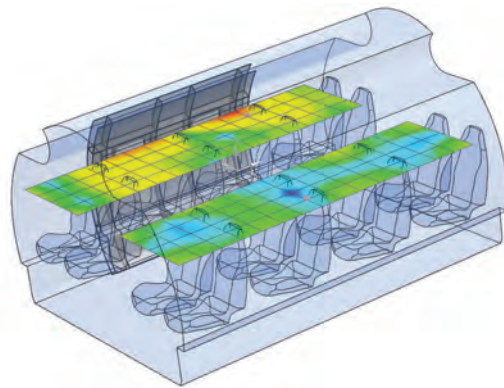

Simcenter 3D Environment for BEM Acoustics

Simcenter 3D Environment for BEM Acoustics software supports generating a ready-to-run acoustic or vibro-acoustic simulation model for direct BEM and indirect BEM solvers, and provides comprehensive postprocessing tools to analyze the acoustic or vibro-acoustic results.

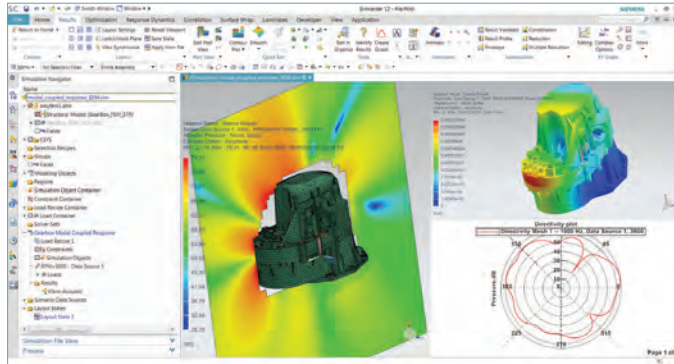
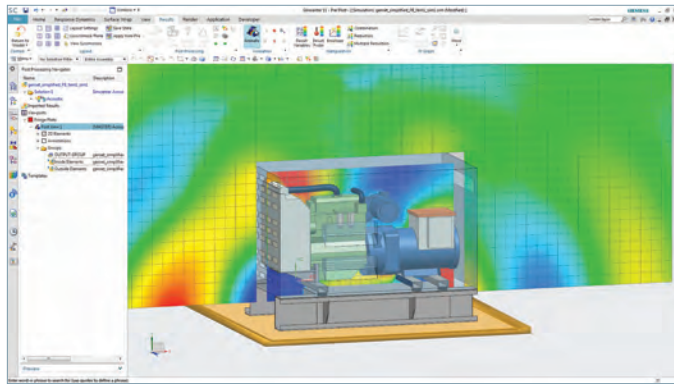

Module benefits

- Provide a user-friendly interface to streamline acoustic BEM model creation for both standard as well as accelerated BEM solvers
- Support pure acoustic problems as well as weakly or fully coupled vibro-acoustics response via modal-based definition of the structure
- Leverage dedicated postprocessing capabilities to improve users' engineering insight and productivity

Key features

- Provide all standard structural and acoustic loads and boundary conditions to describe your vibro-acoustic problems accurately
- Prepare deterministic as well as random acoustics and vibro-acoustics analysis
- Standard postprocessing of acoustic results like pressure and acoustic power and structural vibrations
- Dedicated diagnostic plots showing panel contributions and structural modal contributions to the acoustic pressure or power

Simcenter 3D Acoustics BEM solver

The Simcenter 3D Acoustics BEM solver is used to predict the acoustic response in both enclosed and unbounded domains using a mesh for only the boundary of the fluid domain. Vibro-acoustic analysis is supported by coupling the acoustic fluid with a structural modal model. Structural vibrations can also be imposed on the BEM fluid using weak vibro-acoustic coupling.

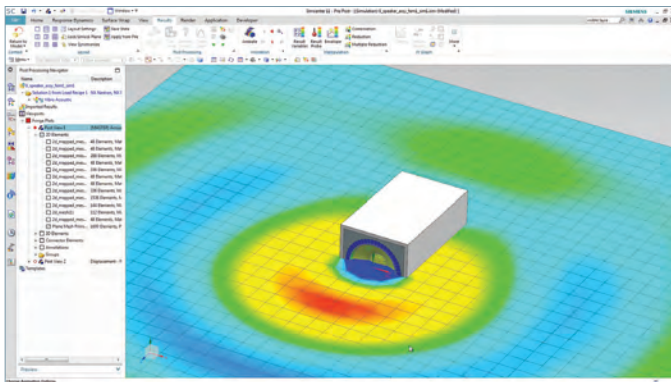
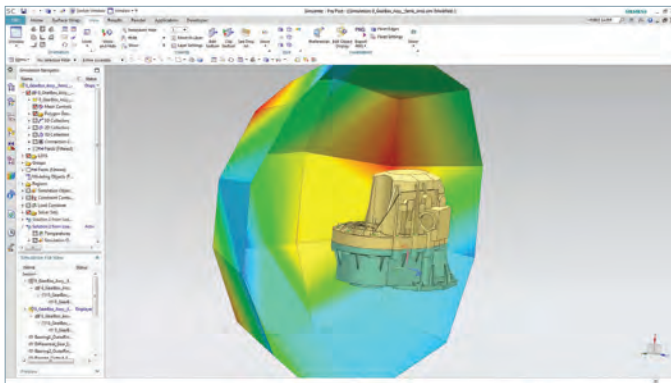

Module benefits

- Fast and efficient BEM solvers for solving both purely acoustic as well as vibro-acoustic problems
- A multitude of acoustic and structural loads and boundary conditions are supported for an accurate description of your vibro-acoustic simulation model
- Automatic BEM model corrections for free and junction edges

Key features

- Direct and indirect acoustic uncoupled solutions
- Indirect vibro-acoustic, weakly coupled and strongly coupled solutions
- Deterministic as well as random acoustics and vibro-acoustics analysis
- Returns standard acoustic and structural response results
- Provides structural panel contributions and modal contributions to the acoustic pressure or power

Simcenter 3D Acoustics Accelerated BEM solver

The Simcenter 3D Acoustics Accelerated BEM software provides hierarchical matrix (H-Matrix) BEM and fast multipole (FM) BEM solvers to extend the computational limits of standard solvers. These solvers are well suited for exterior acoustics of large structures like vehicles and large engines, aircraft, ships, submarines as well as high-frequency applications such as ultrasonic sensors.

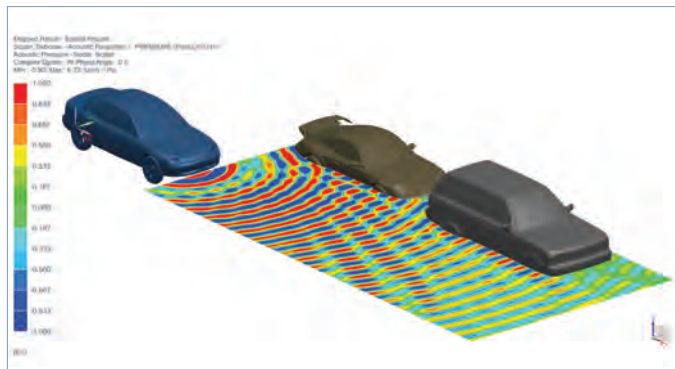
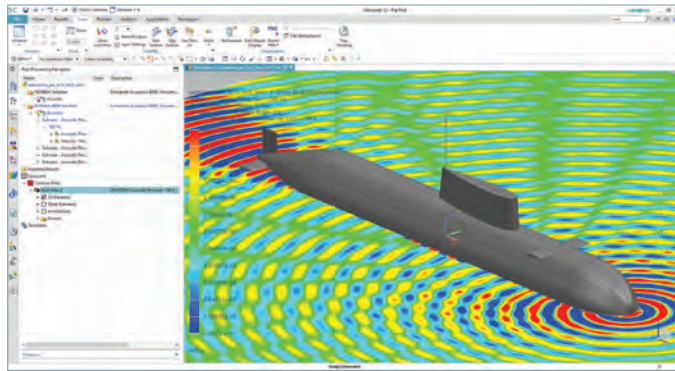

Module benefits

- Provides faster computations for large BEM models (larger geometry and/or higher frequencies)
- Requires lower system memory than standard BEM
- Supports uncoupled acoustics response as well as coupled vibro-acoustics response simulation

Key features

- Includes an iterative fast multipole solver as well as a direct hierarchical H-Matrix solver
- Both solvers support parallel computing, including up to four processes for free, or using more than four processes when combined with Simcenter 3D Acoustics High Performance Computing (HPC) software
- Supports the convection effect of a (uniform) mean flow on the acoustic wave propagation

Simcenter 3D Acoustics Time Domain BEM solver

Simcenter 3D Acoustics Time Domain BEM software enables BEM solutions to solve transient acoustic and vibro-acoustic phenomena. As opposition to the frequency-domain based BEM solvers, Simcenter 3D Acoustics Time Domain BEM Solver gives the possibility to solve problems involving impulsive short time excitation signals in the time domain. This BEM solver is well suited for applications such as parking sensor design and door slam analysis, for instance.

Module benefits

- Allows for accurate modeling of transient infinite domain problem
- Provides solutions for purely acoustics and vibro-acoustic problems
- Provides fast, efficient solver in time domain, also for large models

Key features

- Dedicated solver environment Simcenter 3D Acoustics Transient BEM for time-domain BEM computations, including two analysis types: transient acoustic and transient vibro-acoustic
- Supports multiple loads and boundary conditions:
 - Transient acoustic: acoustic monopole, plane wave, infinite plane, acoustic absorber, transfer admittance
 - Transient vibro-acoustic: force applied on structure (with mode set representation), pre-computed vibrations, infinite plane, acoustic absorber, transfer admittance, panel

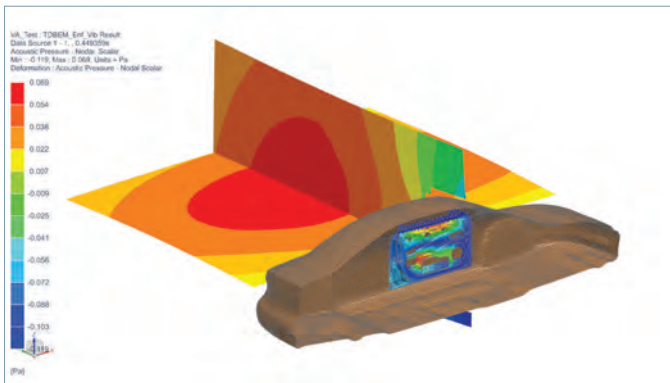
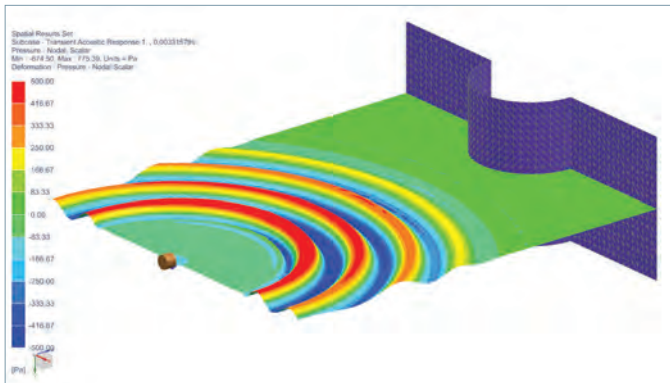

Simcenter 3D Acoustics HPC

Simcenter 3D Acoustics HPC software enables you to execute acoustic FEM or BEM computations in multi-processing mode on the parallel hardware of your choice. Parallel calculation sequences are implemented using the message passing interface (MPI) communication standard. In the case of FEM vibro-acoustics, this product embeds the distributed memory parallelization (DMP) capability of Simcenter Nastran.

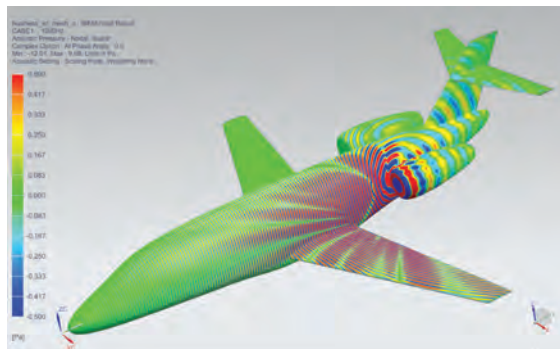
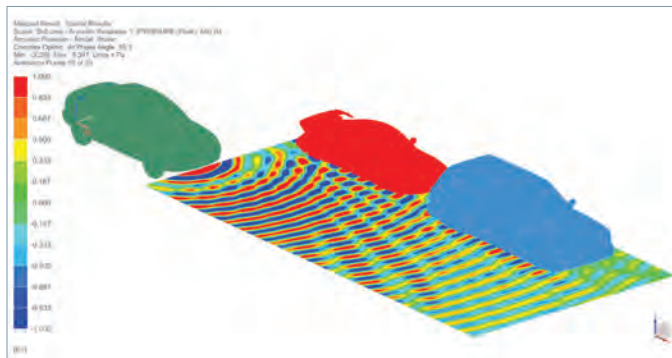

Module benefits

- Accelerates acoustic computations using multithreading, shared memory parallelization (SMP), multiprocessing and DMP
- This product supports high-performance computing for Simcenter 3D Acoustics FEM and BEM solvers

Key features

- Solvers can run in high-performance computing mode on multi-node clusters as well as on multi-core workstations
- Allows you to tackle problems with many frequencies with DMP for which a near-linear parallel speed up can be expected

Capabilities chart

General capabilities	Specific capabilities							FEM acoustics			BEM acoustics			Simcenter 3D Acoustics HPC
		Simcenter 3D Meshing for Acoustics	Simcenter 3D Noise and Vibration Modeling *	Simcenter Nastran Basic **	Simcenter Nastran Dynamic Response *	Simcenter Nastran Advanced Dynamics bundle *	Simcenter Nastran Advanced Acoustics	Simcenter 3D ATV	Simcenter 3D Aero-Vibro-Acoustics	Simcenter 3D Environment for BEM Acoustics	Simcenter 3D Acoustics BEM solver	Simcenter 3D Accelerated BEM solver	Simcenter 3D Acoustics Time Domain BEM solver	
Meshing	Surface wrapper mesh for FEM and BEM acoustics	•												
	Convex surface mesher	•												
	2D mesh with thickness (volumize)	•												
	Hybrid meshing for acoustics (tetrahedron and hexahedron)	•												
	Automatic open duct mesh creation	•												
	Generate acoustic envelope from structural mesh	•												
	Cavity meshing	•												
	Coarsener/remesher	•												
	Hole filling	•												
Rib removal	•													
Boundary condition	Acoustics loads: monopoles, plane waves						•						•	
	Acoustics loads: panel normal velocity						•						•	
	Acoustics loads: dipoles, distributed plane waves, enforced acoustic pressure						•						•	
	Aero-acoustic loads: fan source, surface dipoles								•					
	Turbulent boundary layer loads								•					
	Mapped force loads from flow induced loads		•						•					
	Duct modes						•							
	Transfer admittance to model perforated wall/sheet						•				•			•
	Acoustic absorber (impedance) boundary condition						•					•		
	Acoustic continuity to connect different domains						•							
	Infinite plane to represent reflective surfaces						•					•		
	Anechoic nonreflective boundary (AML)						•							
	Anechoic end duct						•							
Materials	Acoustic fluid						•					•		
	Porous materials - Craggs, Delany-Bazely-Miki and Jonhson-Champoux-Allard						•							
	Temperature dependent fluid for modeling		•						•					
	Temperature dependent fluid for solving						•							

General capabilities	Specific capabilities							FEM acoustics		BEM acoustics				Simcenter 3D Acoustics HPC
		Simcenter 3D Meshing for Acoustics	Simcenter 3D Noise and Vibration Modeling *	Simcenter Nastran Basic **	Simcenter Nastran Dynamic Response *	Simcenter Nastran Advanced Dynamics bundle *	Simcenter Nastran Advanced Acoustics	Simcenter 3D ATV	Simcenter 3D Aero-Vibro-Acoustics	Simcenter 3D Environment for BEM Acoustics	Simcenter 3D Acoustics BEM solver	Simcenter 3D Accelerated BEM solver	Simcenter 3D Acoustics Time Domain BEM solver	
Representations	Mode set representation		•											
	Mode set response			•						•	•	•		
	FRF set representation		•											
	FRF set response					•								
	ATV set representation		•											
	ATV set response							•						
	VATV set representation		•											
Solution	VATV set response							•						
	RDMODES (Recursive domain method for computing structural modes faster)					•								
	Fully/weakly coupled vibro-acoustics with finite element				•									
	Fully/weakly coupled vibro-acoustics with boundary element									•				
	Finite element method (FEM) acoustics					•								
	Finite element method adaptive order (FEMAO) acoustics						•							
	Acoustics transfer vector analysis (ATV)							•						
	Vibro-acoustic transfer vector analysis (VATV)							•						
	Indirect/direct boundary element method (BEM) acoustics									•				
	Hierarchical matrix boundary element method (H-matrix BEM) acoustics										•			
	Fast multipole boundary element method (FMBEM) acoustics										•			
	Transient boundary element method (Transient BEM) acoustics											•		
	Solving up to four parallel processes							•			•	•		
Solving with more than four parallel processes													•	
Post-processing	Pressure, acoustic velocity and intensity at microphone location and acoustic power (scenario based)		•							•				
	Contributions of structural modes, panel and grids on the total acoustic response		•							•				
	Directivity plots		•							•				

Legend:

If several • are present in a single row, interpret as “OR”
 If several cells are merged with one •, interpret as „AND”
 * = refer Simcenter 3D for structural dynamics
 ** = refer Simcenter 3D for structures

Note: Simcenter 3D Engineering Desktop is a minimum prerequisite for all Simcenter 3D products. Other dependency or prerequisites may apply for individual products.

SIEMENS

Ingenuity for life

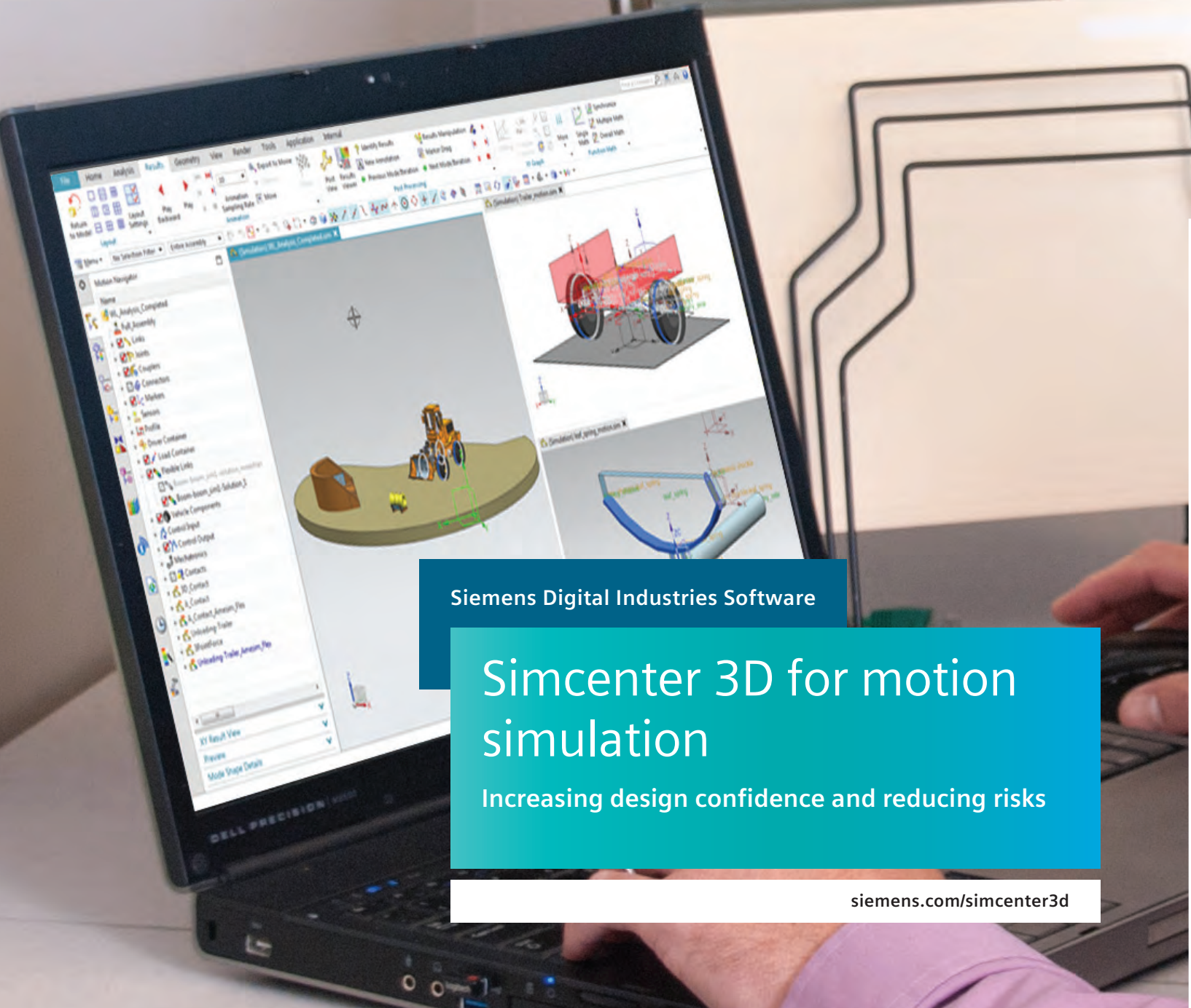

Siemens Digital Industries Software

Simcenter 3D for motion simulation

Increasing design confidence and reducing risks

[siemens.com/simcenter3d](https://www.siemens.com/simcenter3d)



Solution benefits

- Accurately predict complex mechanism behavior
- Quickly build and maintain motion models using an integrated CAE environment
- Integrate systems and controls to simulate mechatronic systems
- Use add-on modules to simulate specific applications like tires, drivetrains or flexible pipes
- Seamlessly share and use motion simulation results across Simcenter 3D as input for use in other types of CAE applications

Simcenter™ 3D software offers modeling and simulation that helps engineers understand and predict the functional behavior of mechanisms. It delivers a complete and robust set of capabilities to support all aspects of advanced dynamic, static and kinematics motion simulation. The early use of motion simulation is key to evaluating mechanism performance to increase design confidence and reduce risks.

Providing a platform for multidiscipline simulation

The Simcenter 3D motion solution is part of a larger, integrated multidiscipline simulation environment with the Simcenter 3D Engineering Desktop at the core for centralized pre-/post-processing for all Simcenter 3D solutions. This integrated environment

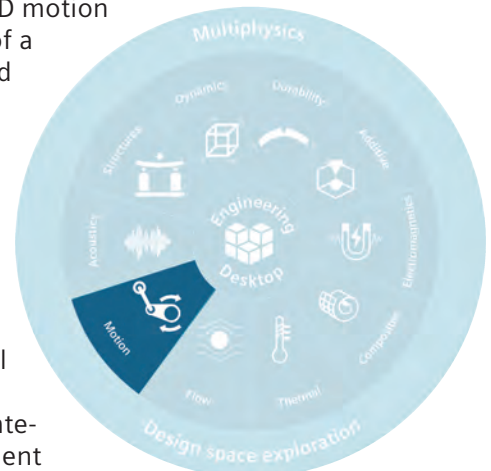

Simcenter 3D for motion simulation

helps you to achieve faster CAE processes and streamline multidiscipline simulations that integrate motion and other disciplines like finite element models for flexible body analysis as well as connections with acoustics for gear whine analysis.

A motion simulation solution for both analysts and designers

Designers and analysts typically approach motion simulation from two different perspectives, where CAD designers start with CAD data, and analysts often start with a blank slate. Simcenter 3D Motion solutions provide solutions that work with either user persona. Analysts can use Simcenter 3D Motion to create new mechanism models by hand using simple primitive geometry for linkages. This helps you understand how a new assembly mechanism might work before applying any detailed geometry. Designers working with computer-aided design (CAD) assembly models during the detailed design stage can quickly convert these assemblies into a working motion model in seconds by converting the geometry bodies into mechanism links and assembly constraints into corresponding motion joints. This can save designers critical modeling time, so they can begin realizing how geometry will impact the performance of their mechanism.

Accurately predict complex mechanism behavior

The Simcenter 3D Motion solver is built on more than 30 years of proven technology and uses the most advanced numerical multibody solving techniques to deliver fast, stable and robust simulation. Additionally, it provides accurate results for reaction forces, displacement, velocities and accelerations for rigid and flexible bodies. The loads obtained from the simulation can also be applied to structural analysis and durability, noise and vibration studies.

Integrate systems and controls to simulate mechatronic systems

Simcenter 3D can be integrated with leading control design tools and supports both model exchange and co-simulation methods to solve the mechanical system equations simultaneously with the controller or actuator system equations. This helps you understand how controls will impact the overall mechanism performance.

Seamlessly share results across Simcenter 3D

For certain types of structural, acoustics, vibration and durability analysis, it is critical to understand the loading conditions for the part or assembly being analyzed. You can seamlessly transfer loading conditions calculated with Simcenter 3D Motion solutions to the Simcenter 3D Engineering Desktop for use in other simulation applications. This will greatly improve productivity for you or your extended simulation team.

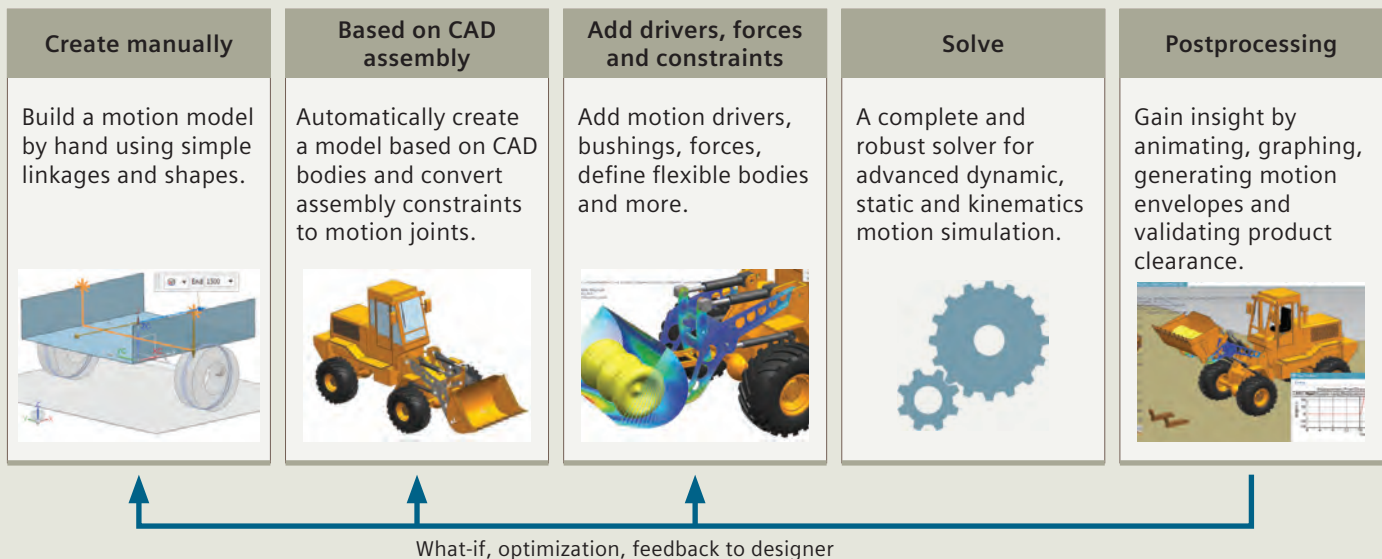

Industry applications

Understanding the operating environments for intricate mechanical systems – such as photocopiers, sliding sunroofs and wing flaps – can be challenging. Motion simulation calculates the reaction force, torque, velocity, acceleration and more for mechanical systems to allow you to study a broad range of product behaviors.

Automotive and transportation

Cars include a wide variety of mechanisms that impact vehicle performance and driver comfort. You can use Simcenter 3D to evaluate suspension and tire performance as well as sunroof, seat and automatic door mechanisms.

Aerospace and defense

Aerospace customers use Simcenter 3D Motion to evaluate landing-gear performance as well as wing-flap mechanisms.

Marine

Using Simcenter 3D can help engineers simulate how rudder systems perform in addition to other on-board mechanisms, like cranes on a cargo ship.

Industrial machinery

Industrial machines move constantly. From complex production machines and robots to conveyors, cranes and heavy equipment, machine developers can use Simcenter 3D to enable their machine to perform as expected.

Electronics

Electronics often have complex, well controlled moving mechanisms. Simcenter 3D can help you simulate the motion of photocopiers, scanners, disk drives and more.

Consumer products

Washing machines, dishwashers and toys all have mechanisms that end users rely on to meet their needs. Simcenter 3D can help you efficiently engineer these mechanisms.



Rigid body
 Flexible body
 Tire models
 Co-simulation with controls
 Interference checking
 Drivetrain



Simcenter 3D Motion Modeling

Simcenter 3D Motion Modeling software provides multibody pre- and postprocessing capabilities to model, evaluate and optimize mechanisms. The module delivers a complete, yet simple-to-use set of capabilities to study the complex aspects of kinematics and dynamics during product development in industries such as aerospace, automotive, industrial machinery and electronics.



Module benefits

- Reduce expensive physical prototypes by using motion simulation to understand mechanism performance
- Gain insight into the kinematic and dynamic performance of a mechanism by animating, graphing and generating motion envelopes and validating product clearance

Key features

- Quickly convert CAD geometry and assemblies into fully functional motion models
- Seamlessly transfer motion results to other Simcenter 3D applications for structural analysis, durability, acoustics and more
- Includes a natural and direct interface to Simcenter Amesim™ software for accurate behavior of electronics, hydraulics and control components throughout the system

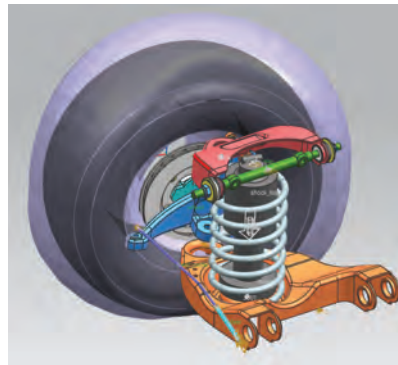
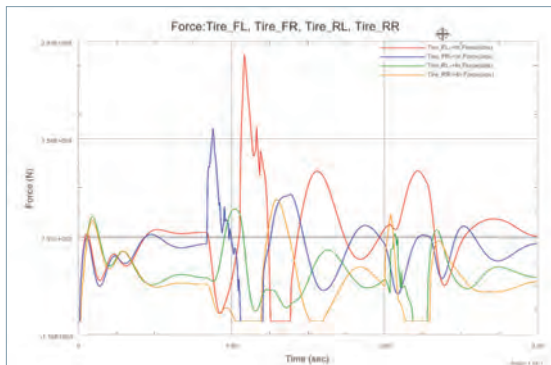

Simcenter 3D Motion solver

Simcenter 3D Motion solver helps engineers predict and understand the functional behavior of parts and assemblies. This multibody dynamic solver delivers a complete and robust set of capabilities to solve all aspects of advanced dynamic, static and kinematics motion simulation.

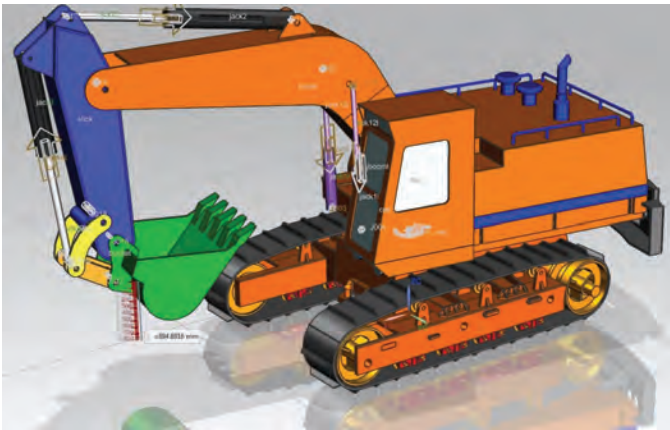
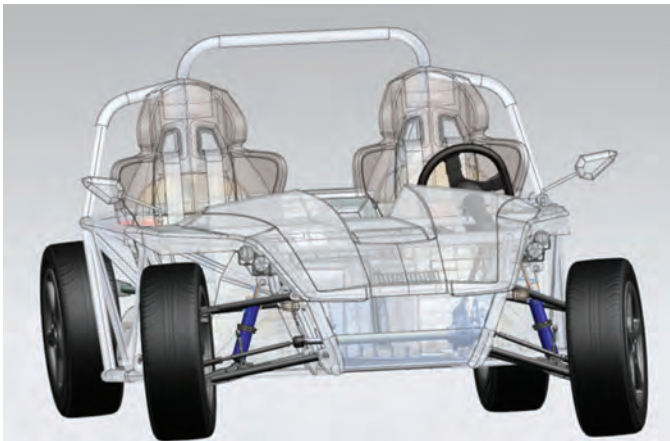

Module benefits

- Achieve highly accurate calculations (displacements, velocities, acceleration, reaction forces, flexible body results) using advanced multibody dynamics solving techniques
- Reduce costly physical prototypes by using motion simulation to understand mechanism performance

Key features

- Analysis types include kinematic, dynamic, static, quasi-static, time and step, articulation (interactively driven), spreadsheet (driven via a live Excel spreadsheet software table)
- An efficient set of sparse matrix algorithms to solve the linear equations formed in each type of analysis
- Explicit and implicit numerical integrators
- Support for model exchange and co-simulation
- User-defined subroutines.
- The Simcenter 3D Motion solver four node allows customers to share solver licenses over multiple cores and machines. It provides the advantage of sharing licenses of some add-on modules across cores and machines

Simcenter 3D Motion Systems and Controls

Mechanical engineers can easily predict how control systems affect their mechanisms, and control engineers can optimize their system designs with Simcenter 3D Motion Systems and Controls. This module provides a library of control modeling elements for the dynamic simulation of mechatronic systems. Through an interface to the MATLAB® environment and the Simulink® environment, you can easily connect motion models directly with control system designs to co-simulate both the motion and control models simultaneously. Simcenter 3D Motion Systems and Controls also includes a generic cosimulation interface for interfacing with other 3rd party or inhouse codes.

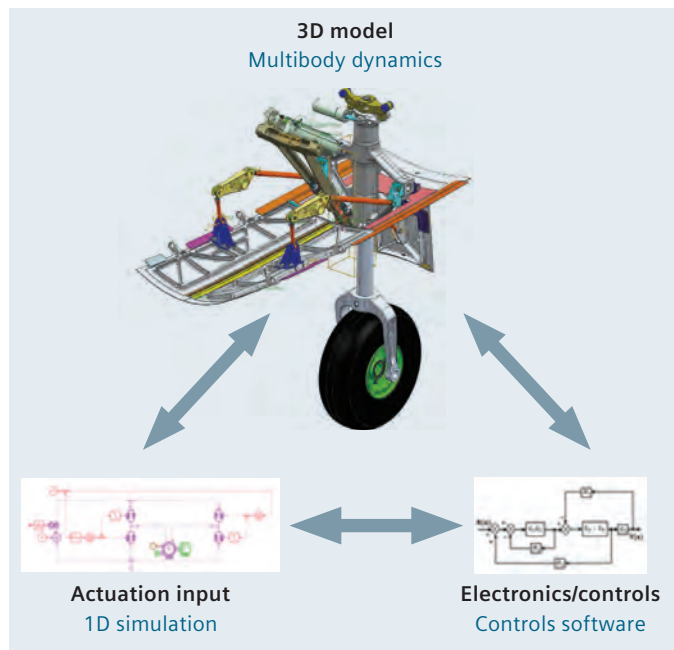

Module benefits

- Reduce risks from early design phases and gain engineering insight by correctly simulating the combined mechatronic system
- Design accurate and robust actuators and controllers

Key features

- Embedded library of control modeling elements
- Interface to MATLAB/Simulink for simulation of full nonlinear mechanical systems, including complex controls and actuators
- Support for Functional Mock-up Interface (FMI) standards

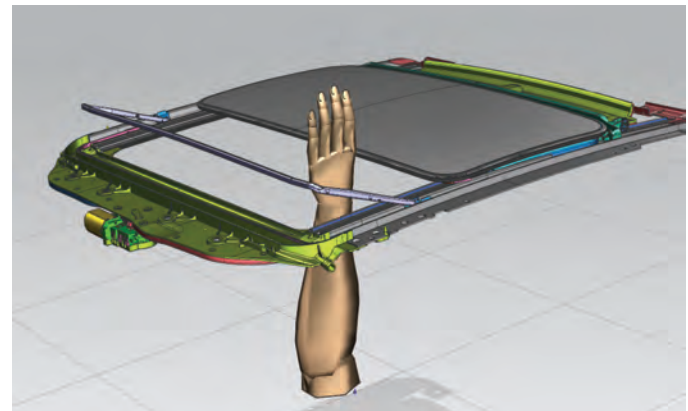

Simcenter 3D Motion Flexible Body

Using Simcenter 3D Motion Flexible Body helps increase the accuracy of multibody models by considering component deformations when simulating the motion of mechanisms. This approach allows you to combine the standard multibody simulation technology with a representation of body flexibility using a set of deformation modes.

Module benefits

- Increase the accuracy of the predicted motion of mechanisms with flexible components
- Accurately predict the structural behavior of a body based on exact loads from connections in a mechanism

Key features

- Component mode synthesis methods available with multiple FE solvers such as Simcenter Nastran® software, MSC Nastran, ANSYS and Abaqus
- Editing of flexible body properties: mass and moments of inertia, modal damping

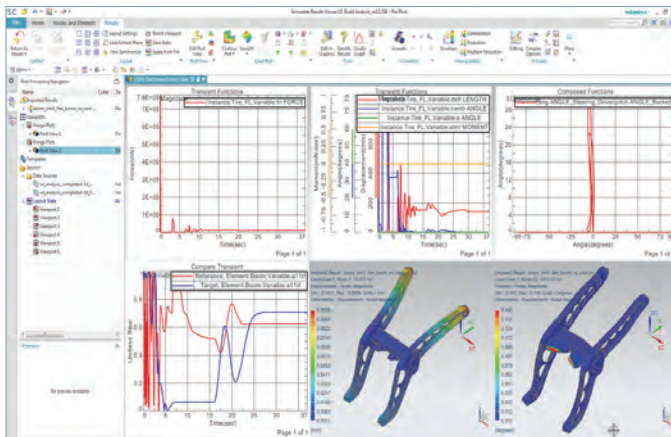
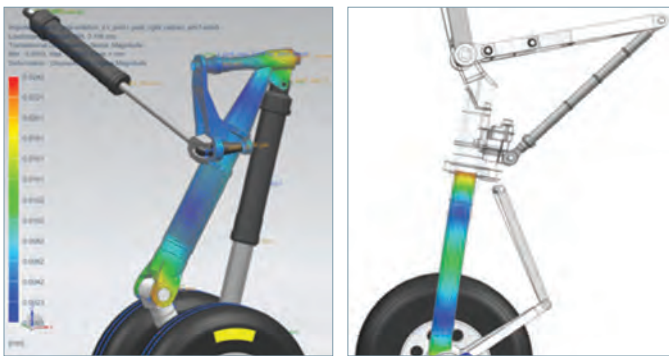

Simcenter 3D Motion Flexible Body Advanced

Simcenter 3D Motion Flexible Body Advanced extends modeling by using an automated process to turn existing geometry into a flexible body for motion analysis. It also allows you to model constraints and contact forces applied to flexible bodies.

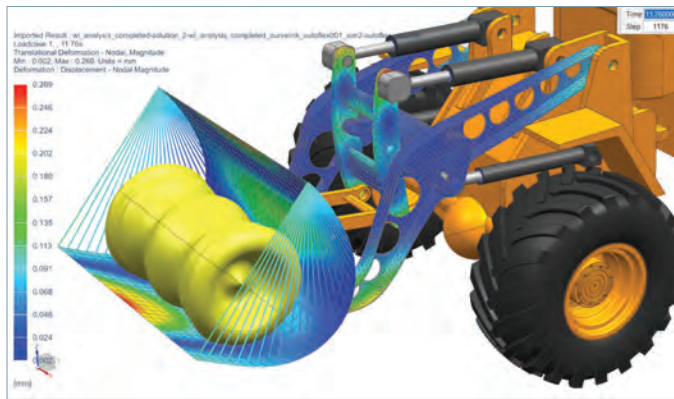

Module benefits

- Simplify the flexible body modeling process with time-saving guided procedures
- Facilitate simulation of distributed loads on flexible bodies due to contacts

Key features

- Automatic flex tool: It takes only a few mouse clicks to go from existing CAD geometry to a complete flexible body with associative finite element (FE) mesh representation and proper boundary conditions based on the connections to the mechanism
- Contact forces on flexible bodies: rigid-to-flex, flex-to-flex
- Point-on-curve constraints extended to flexible curves defined on FE nodes

Simcenter 3D Motion Standard Tire

Using Simcenter 3D Motion Standard Tire enables you to model any force component generated by a pneumatic tire in contact with a road surface, including normal and vertical, longitudinal and lateral, as well as all resulting moments.

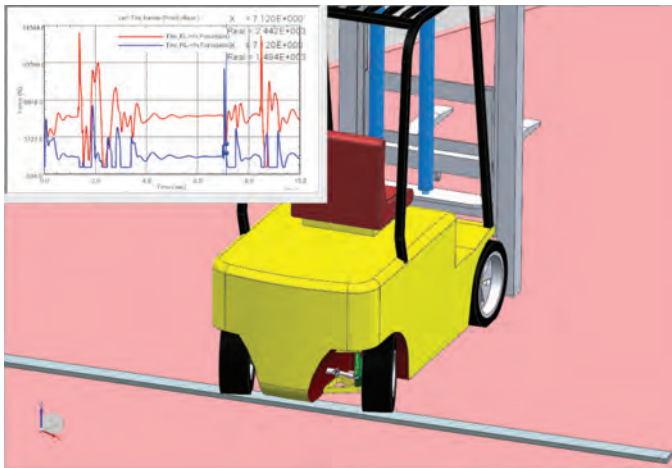

Module benefits

- Accurate prediction of tire-road interactions for computer-aided engineering (CAE) based driving dynamics assessment
- Predict ride comfort and handling performance of a vehicle with a limited number of tire and road parameters

Key features

- Access multiple tire force models with a scalable level of detail; suitable models for passenger cars, trucks and buses, agriculture and construction equipment vehicles and landing gear
- Perform high-frequency analyses, such as full-vehicle ride comfort behavior and durability analysis
- Includes three tire formulation models: noninertial, basic and motorcycle
- Enables support for Flexible Structure Tire Model (FTire) from cosin scientific software

Simcenter 3D Motion CD Tire

Simcenter 3D Motion CD Tire software delivers a family of tire models developed by ITWM Fraunhofer, available as third-party software in Simcenter 3D. These models are suitable for simulation of passenger cars, trucks and buses, off-highway vehicles, motorcycles and aircraft, and enable multibody analysts to accurately predict the tire behavior for full-vehicle handling, ride comfort and durability analyses.



Module benefits

- A dedicated family of tire models for vehicle ride comfort and durability assessment
- Accurately calculate tire forces for vehicles on arbitrary road surfaces
- Build scalable models with different levels of complexity and computational performance

Key features

- Covers a broad frequency range for durability, ride comfort and handling analyses of full vehicles and suspensions

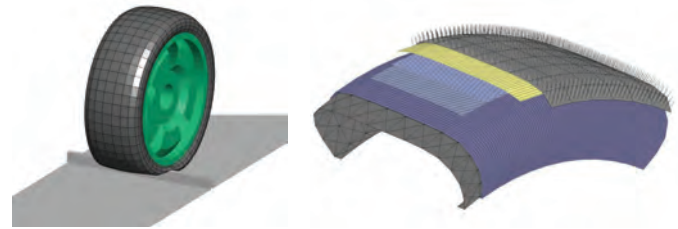

Simcenter 3D Motion MF-Tyre

Simcenter 3D Motion MF-Tyre enables you to create a tire model that corresponds to the Delft-Tyre implementation (revision 6.1.2) of the global standard, the semi-empirical Pacejka Magic Formula from professor Hans Pacejka. These models can be used to accurately and efficiently simulate tire-road contact forces from steady-state to high-frequency analyses for vehicle types such as passenger cars, motorcycles, trucks and aircraft landing gear.

Module benefits

- Simulate tire forces for assessing vehicle handling and controlling prototyping analyses
- Accurately predict vehicle handling behavior, including steady-state cornering, power-off in a turn, lane change, J-turn and more

Key features

- Model the steady-state and dynamic behavior of the tire within a frequency band that covers vehicle-handling analyses, as well as control prototyping and rollover simulations
- Simulate vehicle control systems such as antilock braking system (ABS), electronic stability control (ESP), vehicle dynamic control (VDC) and traction control system (TCS)

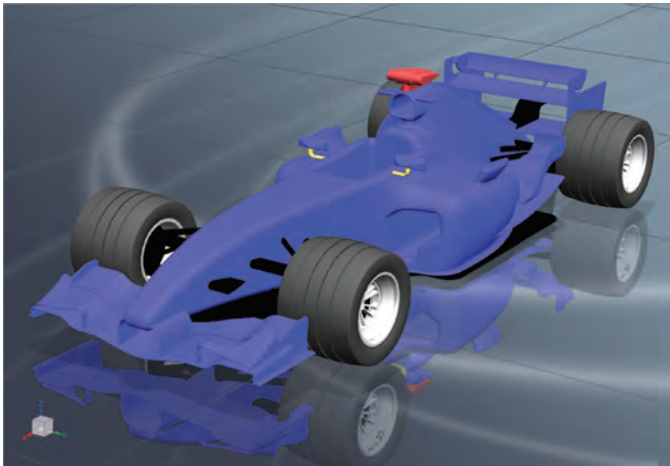

Simcenter 3D Motion MF-Swift Tyre

Using Simcenter 3D Motion MF-Tyre enables you to create a tire model that corresponds to the Delft-Tyre implementation (revision 6.2.0) of the global standard, the semi-empirical Pacejka Magic Formula from Pacejka. Simcenter 3D Motion MF-Swift is the higher-frequency extension, up to about 100 hertz (Hz) of the Magic Formula MF-Tyre model, enabling accurate full vehicle ride comfort, durability and vibration analyses. It can simulate vehicle control systems such as ABS, ESP, VSC, TCS and more over a wide range of operational conditions.

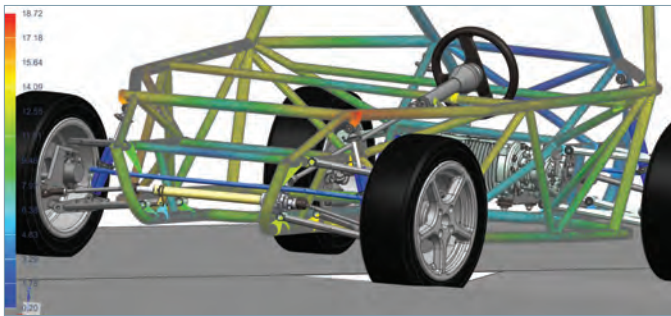

Module benefits

- Simulate tire forces for assessing vehicle handling and controlling prototyping analyses
- Accurately predict vehicle-handling behavior, including steady-state cornering, power-off in a turn, lane change, J-turn and more

Key features

- Extend the industry-standard Pacejka Magic Formula to higher-frequency applications such as vehicle ride comfort, suspension and driveline vibration analyses

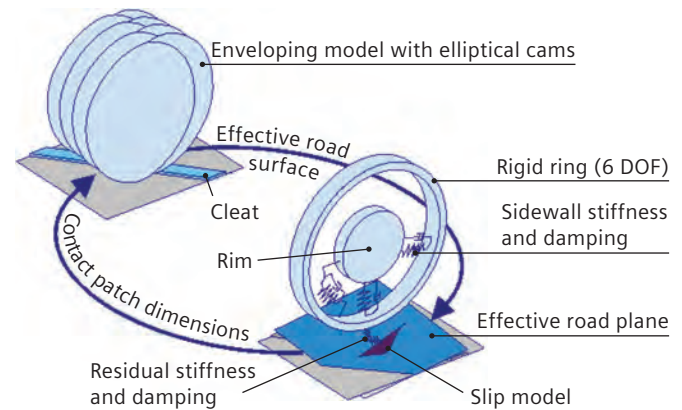

Simcenter 3D Motion Drivetrain

For the dynamic simulation of drivetrain elements, Simcenter 3D Motion Drivetrain groups several tools and features to facilitate creating detailed drivetrain models. The transmission builder brings in-depth, gearbox-specific ease of use into the multibody simulation process, so you can rapidly move from initial design specifications to accurate simulations. The discrete drivetrain capability also provides a convenient interface to simplify the modeling of complex chain, track and belt systems.

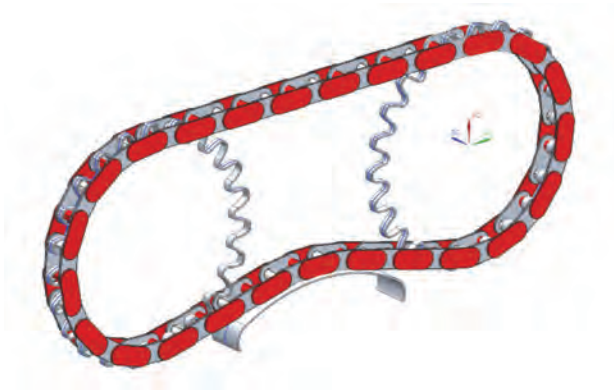
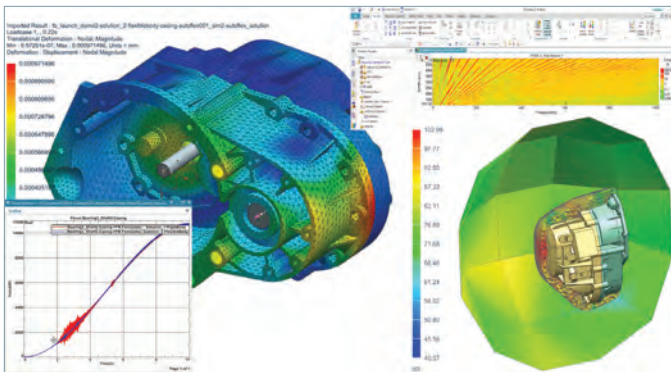

Module benefits

- Automatically create multibody transmission models based on industry standards, reducing time for creating models by up to 80 percent
- Perform end-to-end transmission simulation processes in a single environment
- Achieve reliable and fast multibody gear simulations with validated advanced solver methodologies
- Facilitate robust layout algorithm by using discrete drivetrain to simplify modeling of chain, belt and tracked systems, yet allow for creating custom geometry
- Get insight into complex dynamics of chain, belt and tracked systems to improve performance

Key features

- Automated multibody model creation for transmissions based on industry standards
- Manages single, multi-stage spur and helical assemblies for external or internal (such as in the planetary stage) gears
- Direct link to Simcenter 3D Acoustics to perform noise, vibration and harshness (NVH) assessment
- Define any pattern body with custom geometry such as chain links and track segments together with their connecting joints and forces
- Define layout components based on user-defined topology
- Predict the transient dynamic response – displacement, velocity, acceleration and loads on all pattern bodies and the related layout components



Simcenter 3D Motion TWR

Simcenter 3D Motion TWR (time waveform replication) software is a vertical application that leverages the software's multibody dynamics capabilities. It allows you to build a virtual test rig, calculate the frequency response of a given system, specify target signals, filter and condition the signals and ultimately produce conditioned drive signals using an iterative solution process.

Module benefits

- Reduce cost, save time and mitigate unnecessary risks associated with handling physical specimens in the lab by building a virtual test rig to excite a model of the specimen
- Enables you to perform vehicle simulation without hard to characterize tires and roads

Key features

- Compute a set of inputs that guarantees the equilibrium of your numerical model during simulation and the replication of many physical quantities measured at the same location as the experimental test

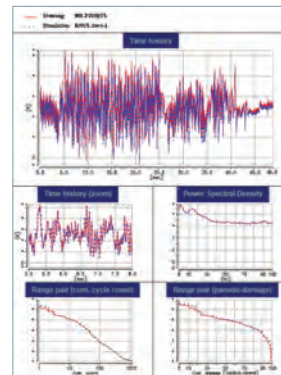
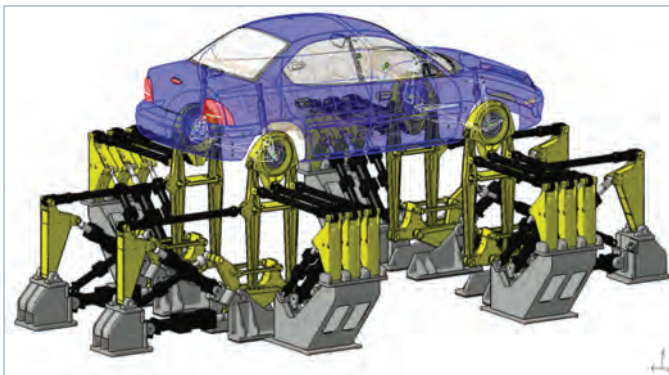

Simcenter 3D Motion Real-Time solver

The Simcenter 3D Motion Real-Time solver and supporting licenses enhance the capabilities of Simcenter 3D Motion models. It enables the user to unlock new external model integration possibilities; add a model to a real-time (RT) platform, integrate with other multi-physics models and combine with RT simulators and hardware-in-loop (HiL). Re-use existing models or extend the accuracy of RT models by adding more degrees-of-freedom (DOF) than ever possible with previously reduced models.

Module benefits

- Re-use Simcenter 3D Motion models in real time instead of recreating multiple models
- Avoid reducing models and maintain the original DOF
- Produce results faster for design-of-experiments (DOE)

Key features

- Available parallel solution for large industrial models
- Flexible body support
- Simcenter 3D Motion C-code export converts the model files into a format that can be used on third-party, real-time operating systems or in integration environments
- Simcenter 3D Motion Real-Time solver licenses are available to support the application and hardware that exist at the customer site

Simcenter 3D Flexible Pipe Standard Beam

Simcenter 3D Flexible Pipe Standard Beam software is an application dedicated to piping and tubing simulation. It allows designers and mechanical engineers to simulate mounting scenarios and calculate initial positions, operating positions and forces/moments within the pipe. In addition, it can be used to prevent a lack of fit between connectors and clips and check for excessive curvature or collision with other objects.

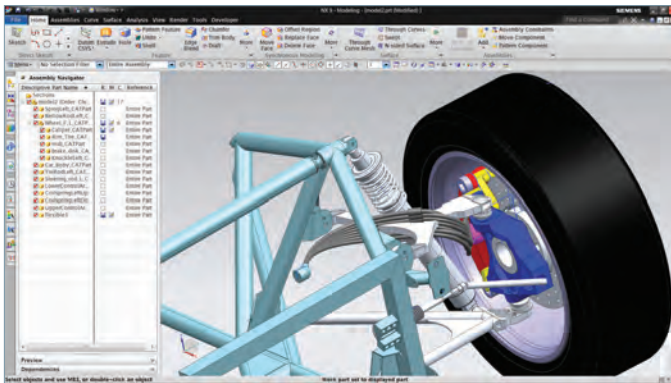

Module benefits

- Rapidly design flexible cables
- Avoid mounting/collision problems
- Provide accurate solutions by considering material properties
- Prevent fatigue problems by avoiding torsion in the mounting position
- Monitor reaction forces, torsion and bending radius

Key features

- Automatic zero-torsion analysis
- Compute positioning and kinematic movement of flexible cables (for example, brake cable, gearbox cable, fuel circuit), using the finite element method (FEM) beam calculation method
- Transient time/space temperature and pressure
- Compatible with motion kinematics results from Simcenter 3D

Simcenter 3D Flexible Pipe Standard Shell

Simcenter 3D Flexible Pipe Standard Shell software is an application dedicated to piping and tubing simulation. It allows designers and mechanical engineers to simulate mounting scenarios and calculate initial positions, operating positions and forces/moments within the pipe. In addition, it can be used to validate designs by checking crushing appearance and check for excessive curvature or collision with other objects.

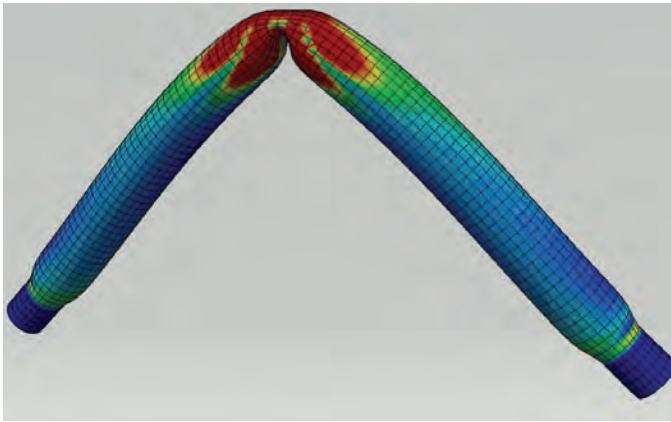

Module benefits

- Rapidly design flexible cables
- Detect crushing/buckling conditions prior to developing physical prototype
- Increase accuracy of results

Key features

- Avoid mounting/collision problems
- Allow definition of multilayer hoses

Simcenter 3D Flexible Pipe Linear Dynamic

Simcenter 3D Flexible Pipe Linear Dynamic is an extension that enables the computation of eigenmodes as well as the harmonic response of positioned pipes using either the FEM beam or the FEM shell calculation method.

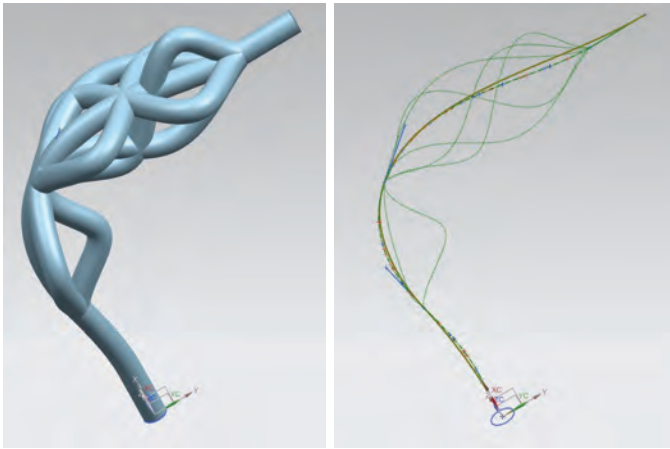

Module benefits

- Rapidly design flexible cables
- Avoid mounting/collision problems
- Detect crushing/buckling conditions prior to developing a physical prototype
- Avoid loose connections and leakage by simulating dynamic (harmonic and transient) effects

Key features

- Compute the eigenmodes as well as the harmonic response of positioned pipes

Simcenter 3D Flexible Pipe Nonlinear Dynamic

Simcenter 3D Flexible Pipe Nonlinear Dynamic is an extension that enables the computation of nonlinear movement analysis (transient response) using either the FEM beam or the FEM shell calculation method.

Module benefits

- Rapidly design flexible cables
- Avoid mounting/collision problems
- Detect crushing/buckling conditions prior to developing a physical prototype
- Avoid loose connections and leakage by simulating dynamic (harmonic and transient) effects

Key features

- Compute the nonlinear movement (transient response) of positioned pipes
- Compare with kinematic positioning
- Impose accelerations or displacements
- Compatible with motion kinematics results of Simcenter 3D
- Sensor monitoring (reaction forces, translation, acceleration)

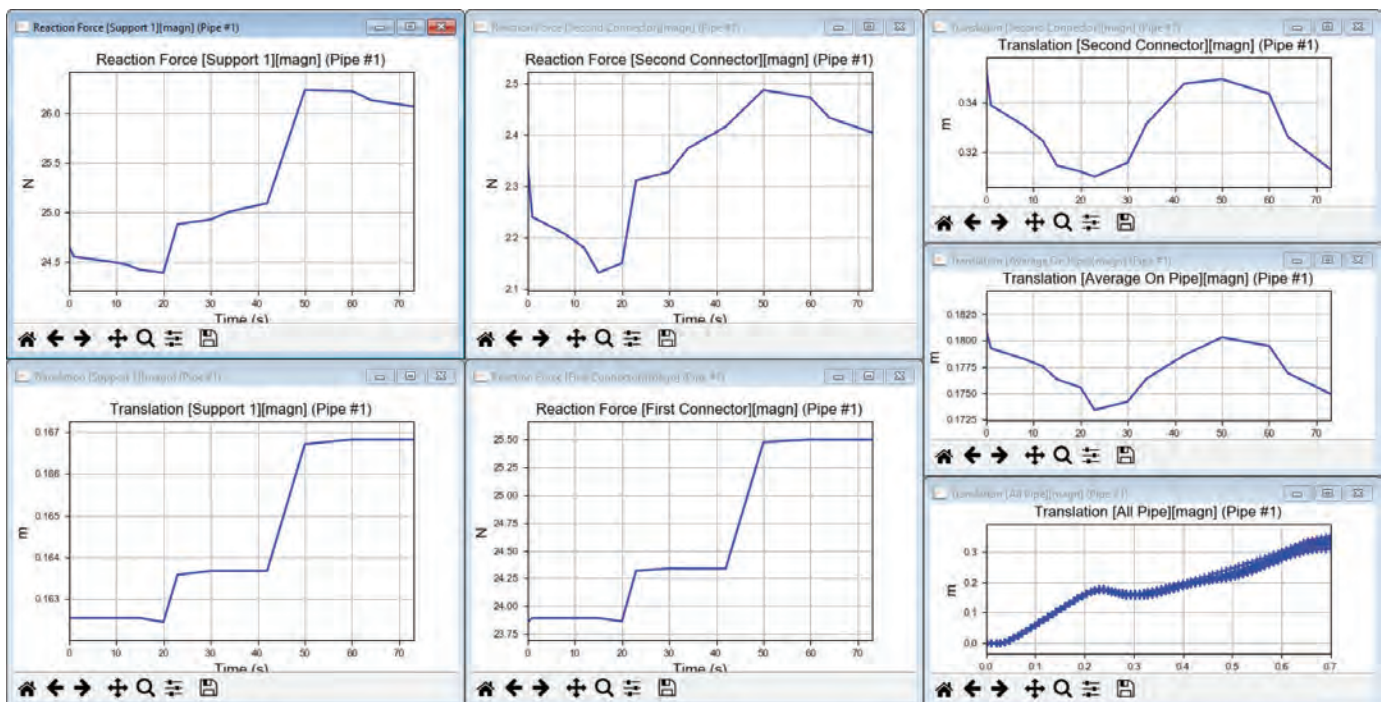

Simcenter 3D Flexible Pipe Optimization

Simcenter 3D Flexible Optimization software is an extension that enables you to compute parametric studies and optimize the position and orientation of components. It also allows the customer to perform a material characterization based on physical measurements.

Module benefits

- Rapidly design flexible cables
- Avoid mounting/collision problems
- Use parametric study to evaluate sensitivity of the design
- Use DOE analysis to explore the design space
- Optimize reaction forces, length, clearance

Key features

- Create parametric studies and optimize the position and orientation of components
- Perform a material characterization based on physical measurements

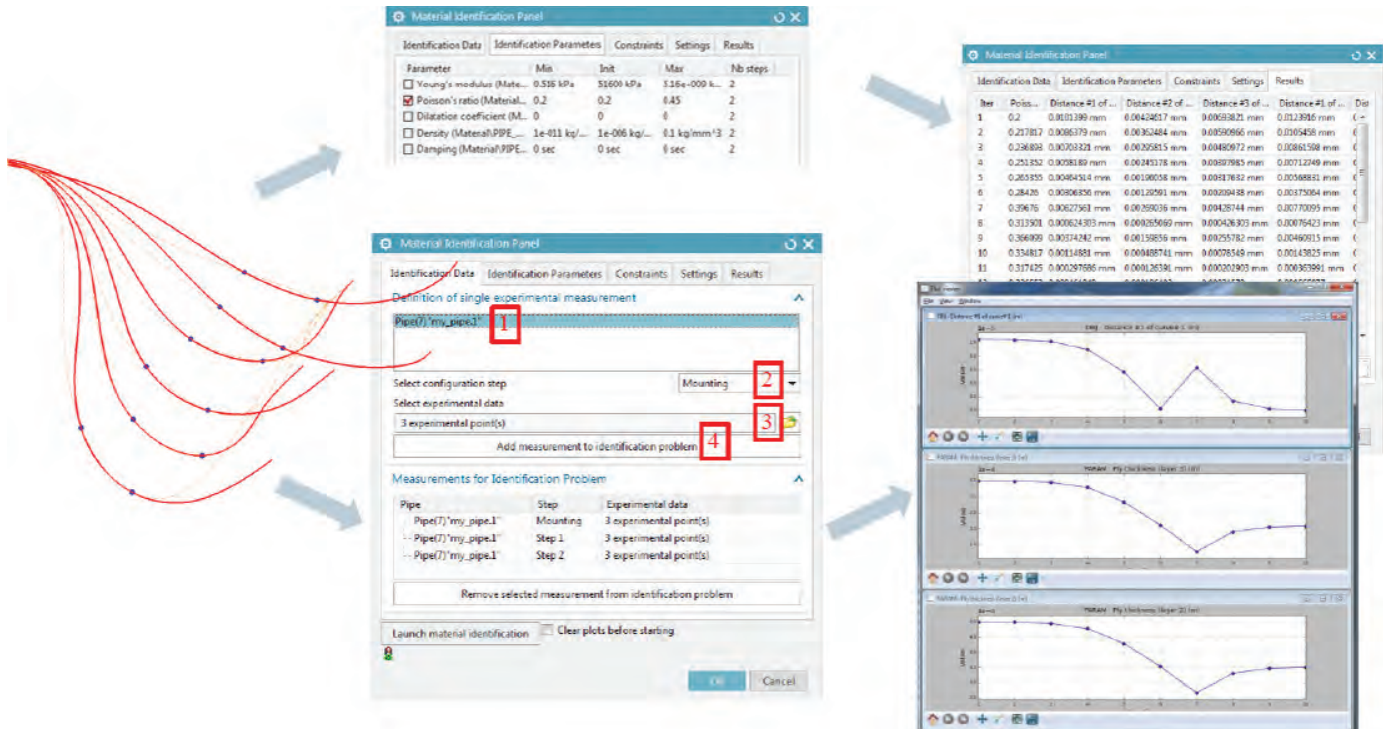

Simcenter 3D Flexible Electric Cables and Wire Harness option

The Simcenter 3D Flexible Electric Cables and Wire Harness (EC&WH) option is an extension that enables you to compute EC&WH. It allows the customer to perform an accurate harness design thanks to a bi-directional link with the NX™ software routing solution and the use of nonlinear materials. This is mandatory in the case of electric cables.

Module benefits

- Rapidly design electric cables and wire harness
- Direct import of existing NX electrical routing model
- Define bundle object (cables enclosed in an external protection layer)
- Accurate positioning and clearance checks of the harness
- Mounting and movements of electric flat cable

Key features

- Plasticity/hysteresis is captured for single cables and bundles
- Material characterization procedure for experimental load curves
- Material characterization procedure for virtual measurement of bundles
- Granularity/scalability of NX electrical routing solution for imported model (wire, cable, stock)
- Multiple cable contact
- Overstocks (taping) and clips (with relaxation) imported in a single click
- Optimal cross-section distribution



NX routing



Linear

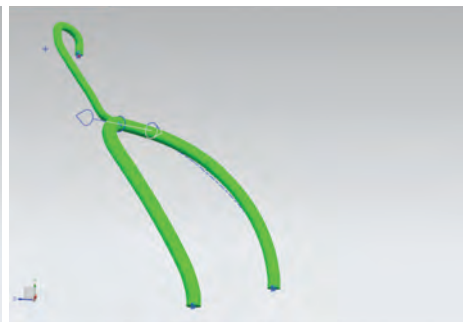

Nonlinear

Capabilities chart

NX and Simcenter 3D Motion capabilities

General capabilities	Specific capabilities	NX Motion	Simcenter 3D Motion Modeling	Simcenter 3D Motion solver	Simcenter 3D Motion Systems and Controls	Simcenter 3D Motion Flexible Body	Simcenter 3D Motion Flexible Body/Advanced	Simcenter 3D Motion Standard Tyre	Simcenter 3D Motion CD Tyre	Simcenter 3D Motion MF-Tyre	Simcenter 3D Motion MF-Swift Tyre	Simcenter Motion Drivetrain	Simcenter 3D Motion TWR	Simcenter 3D Motion Real-Time Desktop Solver	Ccode Exp	RT solver Node locked	Solver batch 4
		Modeling	Import of animation designer, assembly constraint and Tecnomatix® portfolio process simulate kinematics models	•	•												
Association to part and assembly geometry	•	•															
Quick creation of primitive graphics	•	•															
Joints, couplers, constraints	•	•															
Motion drivers	•	•															
Spring/damper and bushings	•	•															
Applied forces	•	•															
Joint friction	•	•															
Initial conditions	•	•															
3D body contact and analytical contact	•	•															
Submechanisms	•	•															
Text based elements		•															
Integration with Simcenter Amesim™ software			•														
Time waveform replication			+	+	+								•				
Postprocessing	Animation	•	•														
XY graphing	•	•															
Motion envelope, interference check, point trace, animation camera, load vectors	•	•															
Capture assembly arrangements during animation	•	•															
Multiple load case support	•	•															
Load transfer to Simcenter 3D Engineering Desktop	•	•															
Multiple output formats (the JT™ data format, VRML, animation movies, etc.)	•	•															
Analysis types and solver capabilities	Static equilibrium	•	+	•													
Kinematic simulation	•	+	•														
Dynamic simulation	•	+	•														
Driver control through articulation and spreadsheet	•	+	•														
User defined forces and subroutines		+	•														
Multi-processor batch solver		+	+														•
Real time solver		+	+										•	+	•		

General capabilities	Specific capabilities																
		NX Motion	Simcenter 3D Motion Modeling	Simcenter 3D Motion solver	Simcenter 3D Motion Systems and Controls	Simcenter 3D Motion Flexible Body	Simcenter 3D Motion Flexible Body Advanced	Simcenter 3D Motion Standard Tire	Simcenter 3D Motion CD Tire	Simcenter 3D Motion MF-Tyre	Simcenter 3D Motion MF-Swift Tyre	Simcenter Motion Drivetrain	Simcenter 3D Motion TWR	Simcenter 3D Motion Real-Time Desktop Solver	Ccode Exp	RT solver Node locked	Solver batch 4
Controls	Integration with Matlab		+	+	•												
	Integration with FMI/FMU 1.0 and 2.0		+	+	•												
	Integration with generic co-simulation		+	+	•												
	Control operations		+	+	•												
Flexible bodies	Linear flexible bodies		+	+		•											
	Automatic flexible body creation		+	+		+	•										
	Flexible body contact		+	+		+	•										
	Flexible body point-line constraint		+	+		+	•										
Drivetrain	Powertrain (combustion, tachometer, HD bearings)		+	+							•						
	Chains and Belts – timing or accessory		+	+							•						
	Transmission builder vertical and gear contact		+	+							•						
Vehicles	Tire/road modeling		+	+				•	•	•	•						
	Track vehicles		+	+							•						

Simcenter 3D Flexible Pipe capabilities

General capabilities	Specific capabilities											
		Simcenter 3D Flexible Pipe Standard Beam	Simcenter 3D Flexible Pipe Standard Shell	Simcenter 3D Flexible Pipe Optimization	Simcenter 3D Flexible Pipe Linear Dynamic	Simcenter 3D Flexible Pipe Nonlinear Dynamic	Simcenter 3D Flexible Pipe EC&WH option	Simcenter 3D Flexible Pipe Advanced Beam	Simcenter 3D Flexible Pipe Standard Beam and Shell	Simcenter 3D Flexible Pipe Simulation for EC&WH		
Modeling	FE hypothesis: long and small diameter pipe (brake hose, electric cable, HVAC, bowden cable)	•								•	•	•
	FE hypothesis: short and big diameter hoses (air/water hoses, FFC, FPC)		•								•	
	FE hypothesis: mostly for advanced thick pipes (electric cable)		•								•	
	Components: connectors, supports	•	•							•	•	•
	Components: separators, collectors (multi-pipes)	•	•							•	•	•
	Collision with external surfaces (check only)	•	•							•	•	•
	Collision with external surfaces (contact)	•	•							•	•	•
	Pipe-pipe contact	•	•							•	•	•
	Pipe-pipe contact using beam/beam contact	•								•	•	•
	Relaxation on connectors/supports/separators/collectors	•	•							•	•	•
	Variable diameter/reinforcements/spirals	•	•							•	•	•
	Advanced materials: elastic/plastic/visco/composite/harmonic	•	•							•	•	•
	Space-time dependent pressure and temperature	•	•							•	•	•
	Link with kinematics : NX Motion	•	•							•	•	•
Link with kinematics : Neutral file, XMO, axis systems, XML (CATIA Replay), arrangements	•	•							•	•	•	

General capabilities	Specific capabilities										
		Simcenter 3D Flexible Pipe Standard Beam	Simcenter 3D Flexible Pipe Standard Shell	Simcenter 3D Flexible Pipe Optimization	Simcenter 3D Flexible Pipe Linear Dynamic	Simcenter 3D Flexible Pipe Nonlinear Dynamic	Simcenter 3D Flexible Pipe EC&WH option	Simcenter 3D Flexible Pipe Advanced Beam	Simcenter 3D Flexible Pipe Standard Beam and Shell	Simcenter 3D Flexible Pipe Simulation for EC&WH	
Modeling (continued)	Pipe bundle: with pipe-pipe contact						•				
	Copy/paste: pipes and assemblies	•	•					•	•	•	
	Corrugated pipe	•	•					•	•	•	
	Corrugated pipe with slit		•						•		
	Bowden cable: cable sliding into an outer layer	•	•					•	•	•	
Analysis types	Quasi-static	•	•					•	•	•	
	Zero/free torsion mounting	•						•	•	•	
	Linear dynamic (frequency domain)				•			•			
	Random analysis (frequency domain)				•			•			
	Nonlinear dynamic (time domain)					•		•			
	Parametric design and optimization			•						•	
	Instant model update (Kineo)	•						•	•	•	
Material identification	Rubber-like hoses			•						•	
	Electric cables						•			•	
	From load curves of 1D pipe			•			•			•	
	Optimization: on assembly of pipes			•						•	
Post-processing	CAD results and animations	•	•					•	•	•	
	FE results/plots/HTML report	•	•					•	•	•	
Integration with other products	Connection with NX routing (stock mode)	•					•	•	•	•	
	Connection with NX routing (cable and wire mode)	•	•					•	•	•	
	Compatibility with Teamcenter® software	•	•					•	•	•	

Legend:

- = included in module
- + = prerequisite

Note: Simcenter 3D Engineering Desktop is a minimum prerequisite for all Simcenter 3D products. Other dependency or prerequisites may apply for individual products.

SIEMENS

Ingenuity for life

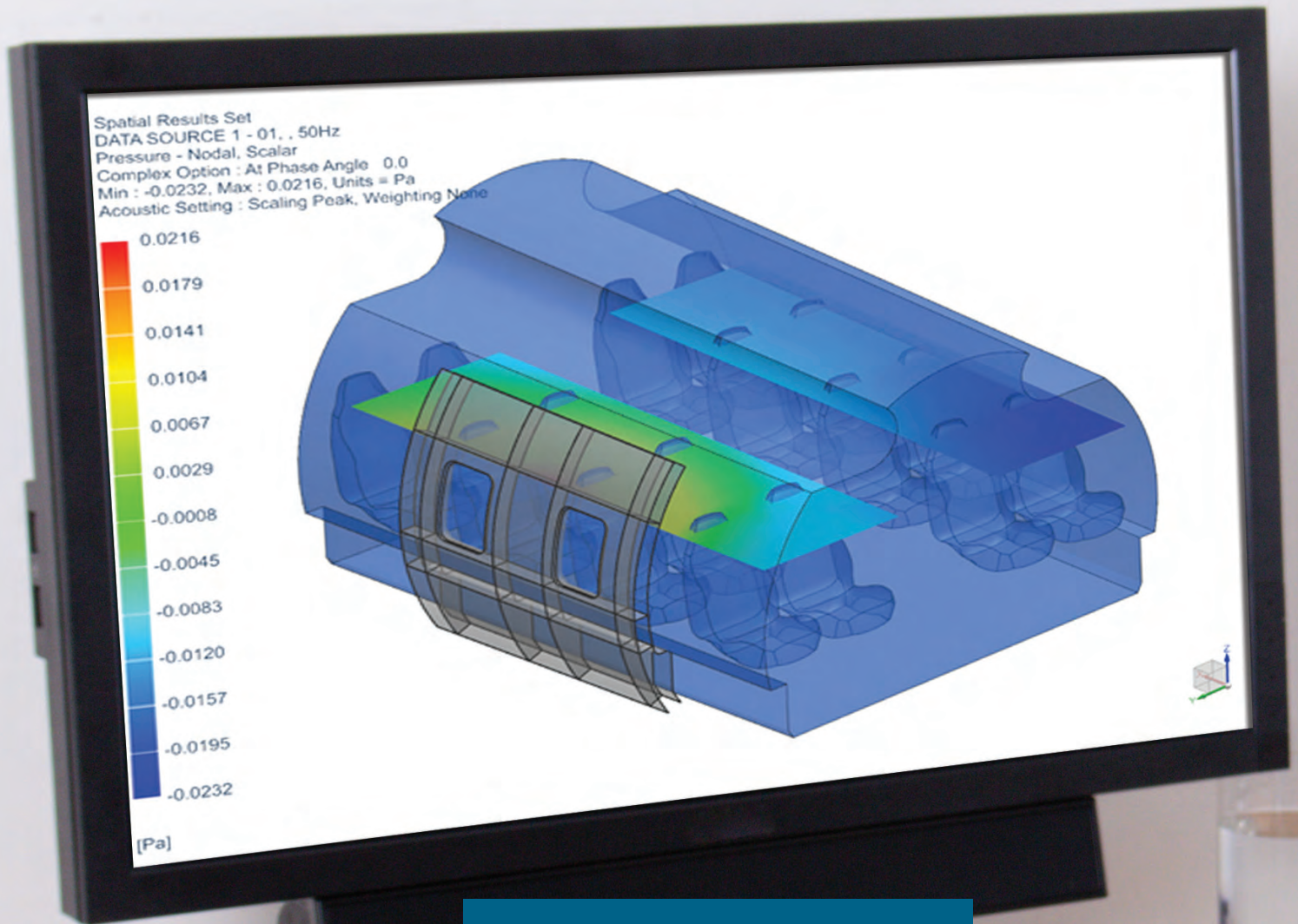

Siemens Digital Industries Software

Simcenter 3D for multiphysics simulation

Leveraging the use of industry-standard solvers
for a full range of applications

[siemens.com/simcenter3d](https://www.siemens.com/simcenter3d)



Solution benefits

- Enables users to take advantage of industry-standard solvers for a full range of applications
- Makes multiphysics analysis safer, more effective and reliable
- Enables product developers to comprehend the complicated behavior that affects their designs
- Promotes efficiency and innovation in the product development process
- Provides better products that fulfill functional requirements and provide customers with a safe and durable solution

Complex industrial problems require solutions that span a multitude of physical phenomena, which often can only be solved using simulation techniques that cross several engineering disciplines. This has significant consequences for the computer-aided engineering (CAE) engineer. In the simplest case, he or she may expect the solution to be based on a weakly-coupled scenario in which two or more solvers are chained. The first one provides results to be used as data by the next one, with some iterations to be performed manually until convergence is reached. But unfortunately, many physical problems are more complex! In that case, a complex algorithmic basis and fully integrated and coupled resolution schemes are required to achieve convergence (the moment at which all equations related to the different physics are satisfied).

Simcenter™ 3D software offers products for multiphysics simulation and covers both weak and strong coupling. The capabilities concern thermal flow, thermomechanical, fluid structure, vibro-acoustics, aero-vibro-acoustics, aero-acoustics, electromagnetic

Simcenter 3D for multiphysics simulation

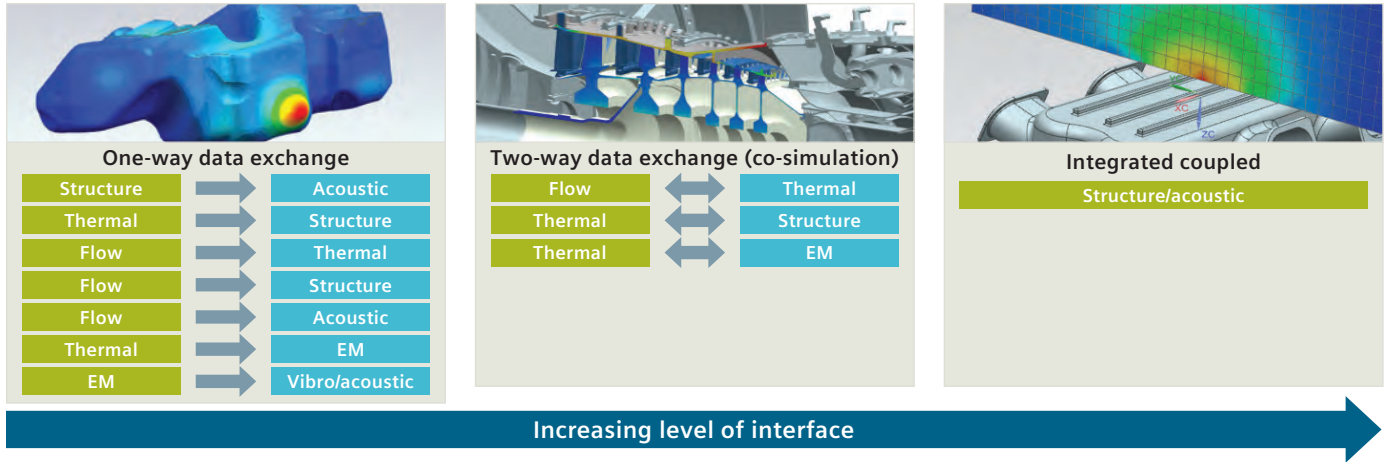

thermal and electromagnetic-vibro-acoustic. Fully coupled issues deal with thermomechanical, fluid-thermal and electromagnetic-thermal problems.

One integrated platform for multiphysics

Simcenter 3D combines all CAE solutions in one integrated platform and enables you to take advantage of industry-standard solvers for a full range of applications. This integration enables you to implement a streamlined multi-physical development process making multiphysics analysis safer, more effective and reliable.

This enables product developers to comprehend the complicated behavior that affects their designs. Understanding how a design will perform once in a tangible form, as well as knowledge of the strengths and weaknesses of different design variants, promotes innovation in the product development process. This results in better products that fulfill functional requirements and provide target customers with a safe and durable solution.

Enabling multiphysics analysis

Realistic simulation must consider the real-world interactions between physics domains. Simcenter 3D brings together world-class solvers in one platform, making multiphysics analysis safer, more effective and reliable. Results from one analysis can be readily cascaded to the next.

Various physics domains can be securely coupled without complex external data links. You can easily include motion-based loads in structures and conduct multi-body dynamic simulation with flexible bodies and controls, vibro-acoustic analysis, thermomechanical

analysis, thermal and flow analysis and others that are strongly or weakly coupled. You can let simulation drive the design by constantly optimizing multiple performance attributes simultaneously.

Quickening the pace of multiphysics analysis

With the help of Simcenter 3D Engineering Desktop, multiphysics models are developed based on common tools with full associativity between CAE and computer-aided design (CAD) data. Any existing analysis data can be easily extended to address additional physics aspects by just adapting physical properties and boundary conditions, but keeping full associativity and re-using a maximum of data.

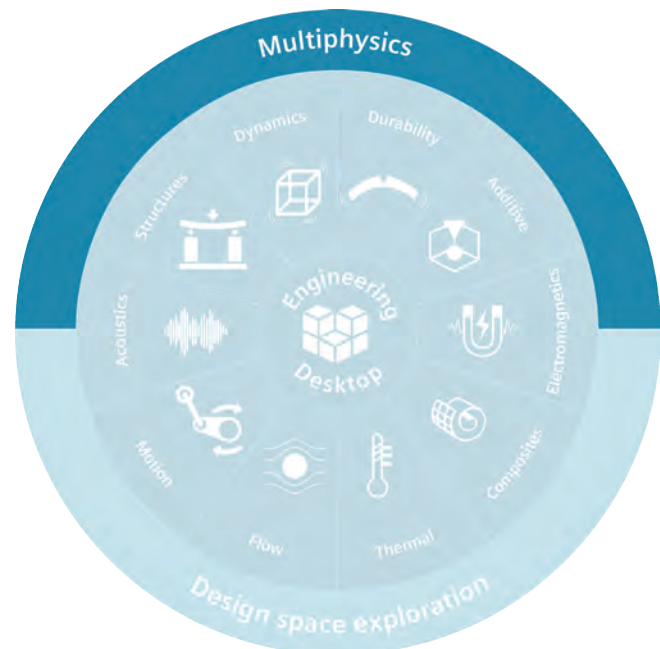

Industry applications

Simcenter 3D multiphysics solutions can help designers from many industries achieve a better understanding of the complex behavior of their products in real-life conditions, thereby enabling them to produce better designs.

Aerospace and defense

- Airframe
 - Thermal/mechanical temperature and thermal stress for skin and frame
 - Vibro-acoustics for cabin sound pressure stemming from turbulent boundary layer loading of the fuselage
 - Flow/aero-acoustics for cabin noise occurring in climate control systems
 - Thermal/flow for temperature prediction in ventilation
 - Curing simulation for composite components to predict spring-back distortion
- Aero-engine
 - Thermal/mechanical temperature and thermal stress/distortion for compressors and turbines
 - Thermal/flow for temperature and flow pressures for engine system
 - Flow/aero-acoustic for propeller noise
 - Electromagnetic/vibro-acoustics for electric motor (EM) noise in hybrid aircraft
 - Electromagnetic/thermal for the electric motor
- Aerospace and defense
 - Satellite: Thermal/mechanical orbital temperatures and thermal distortion
 - Satellite: Vibro-acoustic virtual testing of spacecraft integrity due to high acoustic loads during launch
 - Launch vehicles: Thermal/mechanical temperature and thermal stress for rocket engines

Automotive – ground vehicles

- Body
 - Vibro-acoustics for cabin noise due to engine and road/tire excitation
 - Flow/vibro-acoustics for cabin noise due to wind loading
 - Thermal/flow for temperature prediction and heat loss in ventilation

- Powertrain/driveline
 - Vibro-acoustics for radiated noise from engines, transmissions and exhaust systems
 - Thermal/flow for temperature prediction in cooling and exhaust systems
 - Electromagnetic/vibro-acoustic for EM noise
 - Electromagnetic/thermal for the electric motor performance analysis

Marine

- Propulsion systems
 - Vibro-acoustics for radiated noise from engines, transmissions and transmission loss of exhaust systems
 - Flow/acoustics to predict acoustic radiation due to flow induced pressure loads on the propeller blades
 - Thermal/flow for temperature prediction in piping systems
 - Hull stress from wave loads
 - Electromagnetic/thermal analysis for electric propulsion systems

Consumer goods

- Packaging
 - Thermal/flow for simulating the manufacture of plastic components
 - Mold cooling analyses

Electronics

- Electronic boxes
 - Thermal/flow for component temperature prediction and system air flow in electronics assemblies and packages
 - Flow/aero-acoustics noise emitted from cooling fans due to flow-induced pressure loads on fan blades
- Printed circuit boards
 - Thermal/mechanical for stress and distortion

Making multiphysics simulation more effective and reliable

Using Simcenter 3D enables you to map results from one solution to a boundary condition in a second solution. Meshes can be dissimilar and the mapping operation can be performed using different options.

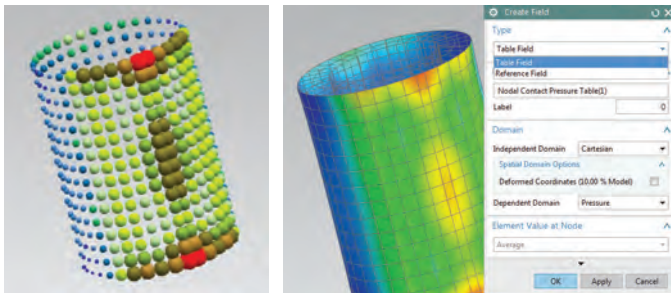
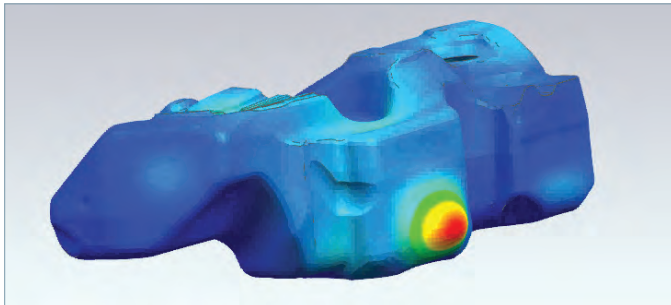

Benefits

- Make multiphysics analysis more effective and reliable by using a streamlined development process within an integrated environment

Key features

- Create fields from simulation results and use them as a boundary conditions: a table or reference field, 3D spatial at single time step or multiple time steps, scalar (for example, temperature) and vector (for example, displacement)
- Map temperature results from Simcenter 3D Thermal to Simcenter Nastran® software
- Use pressure and temperature results from Simcenter 3D Flow in Simcenter Nastran analysis
- Leverage displacement results from Simcenter Nastran for acoustics finite element method (FEM) and boundary element (BEM) computations
- Employ pressure and temperature results from Simcenter STAR-CCM+™ software for aero-vibro-acoustics analysis
- Exploit stator forces results from electromagnetics simulation for vibro-acoustics analysis
- Third-party solvers can be used for mapping: ANSYS, ABAQUS, MSC Nastran, LS-DYNA

Coupling multiphysics simulation of mechanical and thermal problems

Simcenter 3D Advanced Thermal leverages the multiphysics environment to solve thermomechanical problems in loosely (one-way) or tightly coupled (two-way) modes.

This environment delivers a consistent look and feel for performing multiphysics simulations, so the user can easily build coupled solutions on the same mesh using common element types, properties and boundary conditions, as well as solver controls and options.

Coupled thermal-structural analysis enables users to leverage the Simcenter Nastran multi-step nonlinear solver and a thermal solution from the Simcenter 3D Thermal solver.

Benefits

- Extend mechanical and thermal solution capabilities in Simcenter 3D to simulate complex phenomena with a comprehensive set of modeling tools
- Reduce costly physical prototypes and product design risk with high-fidelity thermal-mechanical simulation
- Gain further insight about the physics of your products
- Leverage all the capabilities of the Simcenter 3D integrated environment to make quick design changes and provide rapid feedback on thermal performance

Key features

- Advanced simulation options for coupled thermomechanical analysis of turbomachinery and rotating systems
- Tightly-coupled thermomechanical analysis with Simcenter Nastran for axisymmetric, 2D and 3D representations
- Combines Simcenter Nastran multi-step nonlinear solution with industry-standard Simcenter Thermal solvers

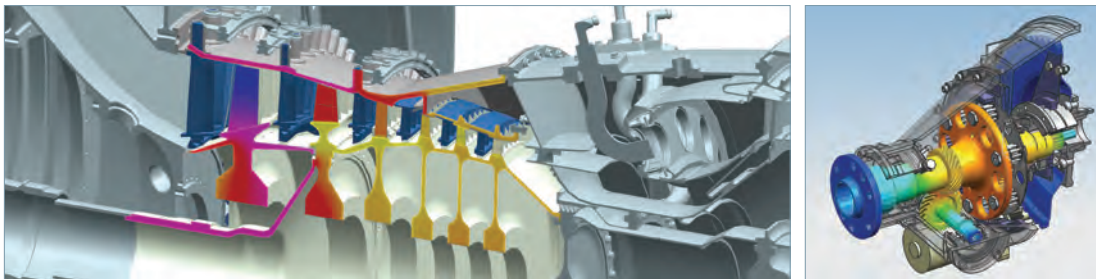

Coupling multiphysics simulation with flow and thermal problems

Simcenter 3D Advanced Flow software is a powerful and comprehensive solution for computational fluid dynamics (CFD) problems. Combined with Simcenter 3D Thermal and Simcenter 3D Advanced Thermal, Simcenter 3D Advanced Flow solves a wide range of multiphysics scenarios involving strong coupling of fluid flow and heat transfer.

Benefits

- Gain insight through coupled thermo-fluid multiphysics analysis
- Achieve faster results by using a consistent environment that allows you to quickly move from design to results

Key features

- Consider complex phenomena related to conjugate heat transfer
- Speed solution time with parallel flow calculations
- Couple 1D to 3D flow submodels to simulate complex systems

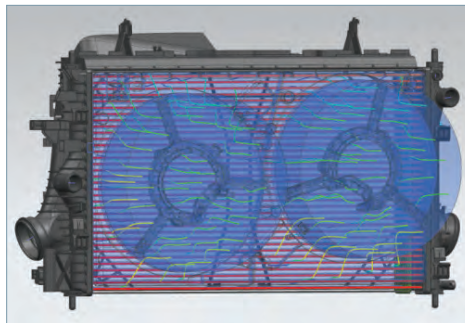
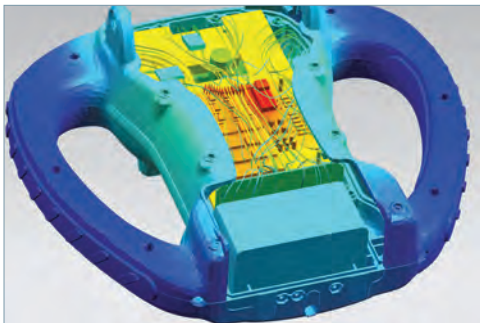

Coupled multiphysics simulation involving dynamics and acoustics

The Simcenter Nastran software Advanced Acoustics module extends the capabilities of Simcenter Nastran for simulating exterior noise propagation from a vibrating surface using embedded automatically matched layer (AML) technology. Simcenter Nastran is part of the Simcenter portfolio of simulation tools, and is used to solve structural, dynamics and acoustics simulation problems. The Simcenter Nastran Advanced Acoustics module enables fully coupled vibro-acoustic analysis of both interior and exterior acoustic problems.

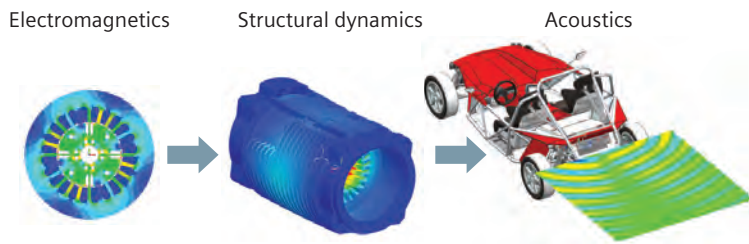

Benefits

- Easily perform both weakly and fully coupled vibro-acoustic simulations
- Simulate acoustic problems faster and more efficiently with the next-generation finite element method adaptive order (FEMAO) solver

Key features

- Simulate acoustic performance for interior, exterior or mixed interior-exterior problems
- Correctly apply anechoic (perfectly absorbing, without reflection) boundary conditions
- Correctly represent loads from predecessor simulations: mechanical multibody simulation, flow-induced pressure loads on a structure and electromagnetic forces in electric machines
- Include porous (rigid and limp frames) trim materials in both acoustic and vibro-acoustic analysis
- Request results of isolated grid or microphone points at any location
- Define infinite planes to simulate acoustic radiation from vibrating structures close to reflecting ground and wall surfaces

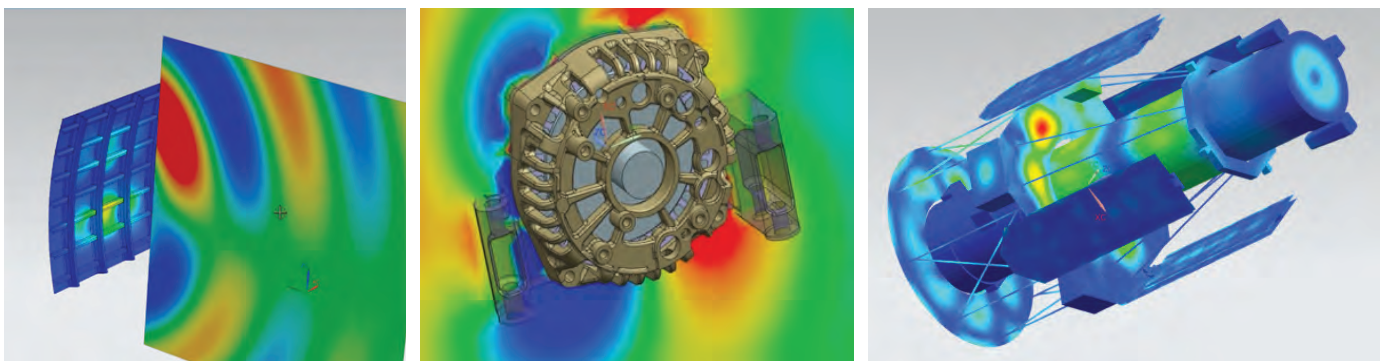

Simcenter 3D Aero-Vibro-Acoustics

This product supports creating aero-acoustic sources close to noise-emitting turbulent flows and allows you to compute their acoustic response in the environment (exterior or interior); for example, for noise from heating ventilation and air conditioning (HVAC) or environmental control system (ECS) ducts, train boogies and pantographs, cooling fans and ship and aircraft propellers. The product also allows you to define wind loads acting on structural panels, leading to vibro-acoustic response; for instance, in a car or aircraft cabin.

Module benefits

- Derive lean, surface pressure-based aero-acoustic sources for steady or rotating surfaces
- Scalable and user-friendly load preparation for aero-vibro-acoustic wind-noise simulations
- Import binary files with load data directly into Simcenter Nastran for response computations

Key features

- Conservative mapping of pressure results from CFD to the acoustic or structural mesh
- Equivalent aero-acoustic surface dipole sources
- Equivalent aero-acoustic fan source for both tonal and broadband noise
- Wind loads, using either semi-empirical turbulent boundary layer (TBL) models or mapped pressure loads from CFD results

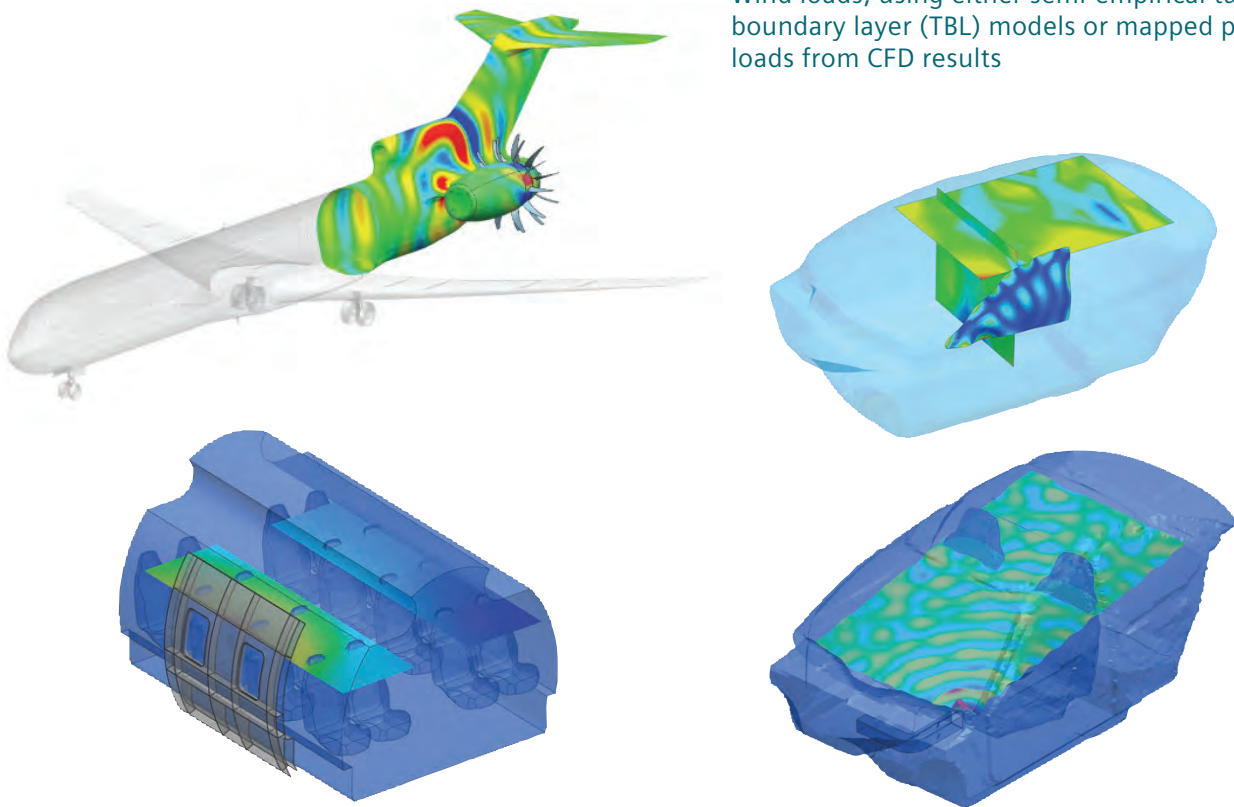

Simcenter 3D Electromagnetics/Thermal

Simcenter MAGNET™ Thermal software can be used to accurately simulate temperature distribution due to heat rise or cooling in the electromechanical device. Simcenter 3D seamlessly couples with the Simcenter MAGNET solver to provide further analysis: You can use power loss data from Simcenter MAGNET as a heat source and determine the impact of temperature changes on the overall design and performance.

Each solver module is tailored to different design problems and is available separately for both 2D and 3D designs.

Module benefits

- Achieve higher fidelity predictions by taking temperature effects into account in electromagnetic simulations
- Leverage highly efficient coupling scenarios

Key features

- Simulates the temperature distributions caused by specified heat sources in the presence of thermally conductive materials
- Couples with Simcenter MAGNET solver for heating effects due to eddy current and hysteresis losses in the magnetic system

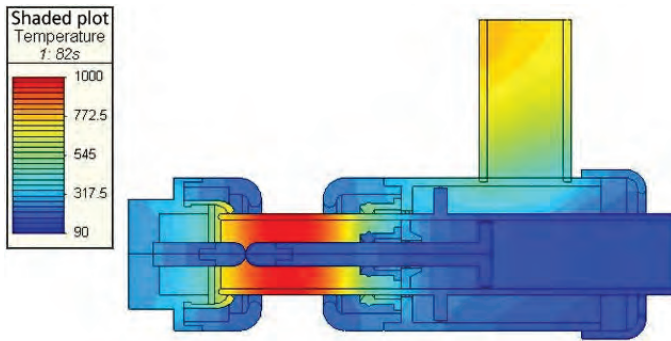



Capabilities chart

General capabilities	Types of coupling		Products involved							
	Weak	Strong	Simcenter 3D structural solutions	Simcenter 3D acoustic solutions	Simcenter 3D thermal solutions	Simcenter 3D flow solutions	Simcenter 3D electro-magnetic solutions	Simcenter 3D motion solutions	Other Simcenter portfolio solutions	Third-party tools
Legend • = type of coupling supported V = vibration A = acoustics F = flow T = thermal M = mechanical/structural S = structural E = electromagnetics FX = flexible body MBD = multibody dynamics/motion C = controls										
Supported analysis types										
Vibro-acoustics (V-A)	•	•	V-A	V-A				V		V
Thermal-mechanical (T-M)	•	•	M		T					
Flow-thermal (F-T)	•	•			T	F			F	F
Fluid-structure interaction (F-S)	•	•	S			F			F	
Thermal-fluid-structure interaction	•	•	S		T	F			F	
Aero-acoustics (F-A)	•		A	A					F	F
Aero-vibro-acoustics (F-V-A)	•	•	V-A	V-A					F	F
Thermal-electromagnetics (T-E)	•	•					T-E			
Vibro-acoustics - electromagnetics (V-A-E)	•		V-A	V-A			E			E
Flexible multibody dynamics (FX-MBD)	•		FX					MBD		FX
Motion-control simulation (MBD-C)		•						MBD	C	C

SIEMENS

Ingenuity for life



Siemens Digital Industries Software

Simcenter 3D for thermal simulation

Facilitating the modeling of nonlinear and transient heat transfer phenomena

[siemens.com/simcenter3d](https://www.siemens.com/simcenter3d)



Solution benefits

- Leverage the Simcenter 3D integrated environment to make quick design changes and provide rapid feedback on thermal performance
- Use Simcenter Nastran to understand thermoelastic effects with coupled physics analysis
- Minimize tedious rework and modeling errors with direct interfaces for ECAD systems
- Analyze condensation, humidity and dust particle transport in electronics systems
- Predict thermal performance for orbiting vehicles accurately and quickly
- Increase collaboration and team productivity with a thermal analysis solution that is easily integrated with your design and engineering process

Simcenter™ 3D software offers a complete solution for modeling nonlinear and transient heat transfer phenomena, accounting for conduction, convection, radiation and phase change. Dedicated thermal modeling capabilities are available, such as rapid thermal connection methods, an extensive physical model library and a wide array of thermal loads and boundary conditions. These provide flexibility and ease-of-use while addressing complex thermal challenges.

Gain reliable thermal insights

A pioneering tool in computational heat transfer modeling, Siemens Digital Industries Software's Simcenter 3D has been continuously developed for over three decades. It boasts a complete element, material and physical model library that is linked to an enriched, high-fidelity solver with a broad set of functionalities. This is further enhanced by intuitive pre-/postprocessing functionalities for thermal analysts.

Simcenter 3D for thermal simulation

Easily handle thermal exchange between dissimilar interfaces

Using Simcenter 3D, thermal connections can be automatically defined between disjoint components, dissimilar meshes and nonconforming geometry. Moreover, mesh congruence and proximity requirements are eliminated, which enables the user to build and solve large assemblies quickly.

Master complexity and productivity in industry verticals

The capabilities of Simcenter 3D for thermal simulation have been leveraged in vertical applications to satisfy specific industry needs. Simcenter 3D Space Systems Thermal enables the user to model the thermal performance and characteristics of orbiting and interplanetary vehicles. Simcenter 3D Advanced Thermal provides advanced capabilities for the aero-engine analyst community to perform analysis on the entire engine.

Automation and customization to manage a wide range of models

Simcenter 3D for thermal simulation provides an extensible solver architecture supporting user subroutines, user plugins, expressions and an open application programming interface (API) to automate and customize the product development workflow according to industry needs.

Providing a platform for multidiscipline simulation

The Simcenter 3D thermal solution is part of a larger, integrated multidiscipline simulation environment with the Simcenter 3D Engineering Desktop at the core for centralized pre-/postprocessing for all Simcenter 3D solutions. This integrated environment helps you to achieve faster CAE processes and streamline multidisciplinary simulation such as thermomechanical analyses based on structural solutions or conjugate heat transfer problems that are coupled with flow solutions.

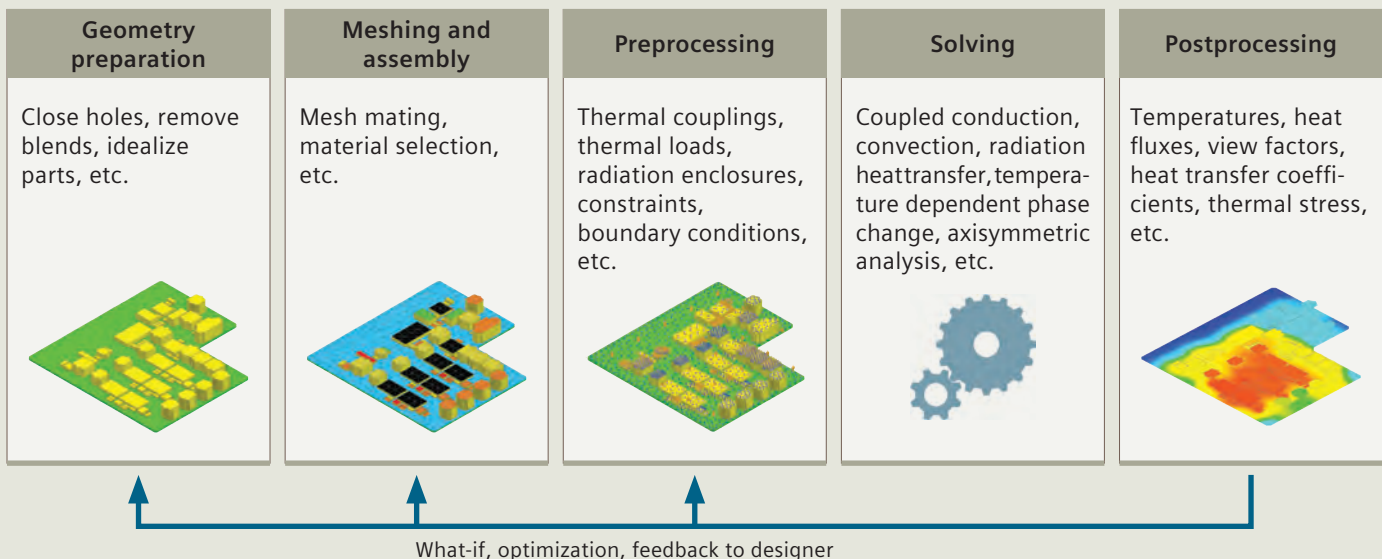

Industry applications

Thermal applications in Simcenter 3D include simulation and analysis for a range of heat transfer problems in aerospace, automotive, electronics, power generation, process and other industries.

Automotive and transportation

Simcenter 3D helps tackle a variety of analysis scenarios, such as under-hood thermal analysis, powertrain thermal management and thermal response and temperatures in automotive lighting systems. Simcenter 3D for thermal offers a complete solution for the thermal design of electric vehicles, including batteries and enclosures.

Aerospace and defense

Simcenter 3D includes the ability to model the thermal response from a single component to a global aircraft system. The aero-engine turbine, compressor and entire engine may be modeled for a thermal analysis or a coupled thermomechanical analysis with Simcenter Nastran® software. Thermal dissipation from electrical components can be modeled using the nonlinear Joule heating capability. Aerothermal or ablation analysis is an area of strength.

Electronics and consumer goods

Simcenter 3D thermal modules can be leveraged to meet the design requirements of compact and complex electronics systems. Examples include identifying recirculation zones and hot spots, predicting thermal response based on spatially varying and orthotropic conductivity and capacitance, and determining cooling strategies and heat sink modeling.

Industrial machinery

Simcenter 3D can be used to simulate a broad category of applications such as laser ablation and cutting, welding thermal response, mold-cooling analyses and phase change thermal analysis. In the cold-chain industry, Simcenter 3D can be used for performing predictive modeling of the quality of frozen and temperature-sensitive materials during shipping and handling.

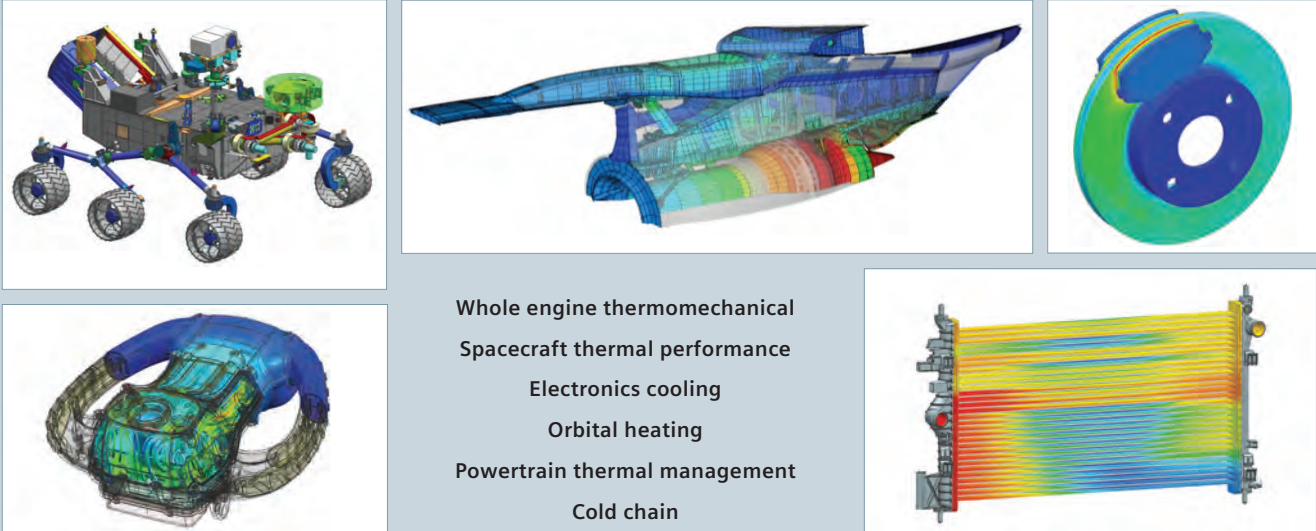

Whole engine thermomechanical
 Spacecraft thermal performance
 Electronics cooling
 Orbital heating
 Powertrain thermal management
 Cold chain



Simcenter 3D Thermal

Simcenter 3D Thermal provides heat transfer solutions and can simulate conduction, convection and radiation phenomena for complex products and large assemblies. The Simcenter 3D Thermal solver is based on a finite-element, finite-volume formulation to simulate heat transfer phenomena accurately and efficiently.

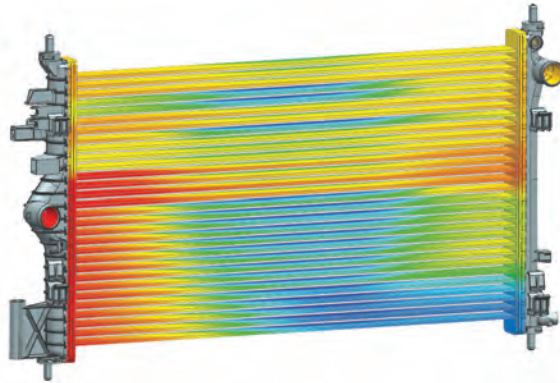
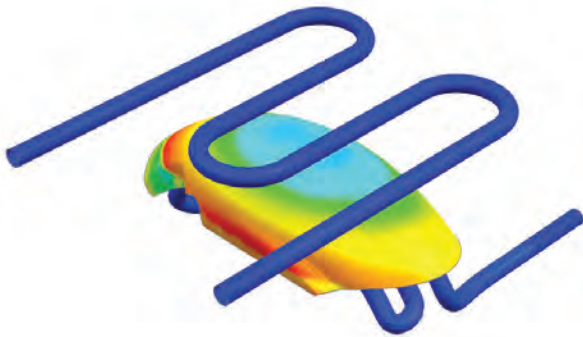

Module benefits

Use Simcenter Nastran software to understand thermomechanical effects of coupled physics analysis
Deliver full assembly finite element method (FEM) support to model complex systems

Key features

Fully coupled conduction, radiation and convection heat transfer simulation to steady-state and transient problems

Axisymmetric modeling and nonlinear thermal properties

Thermally connect disjoint and dissimilar mesh faces and edges

Spatially varying heat transfer coefficients can be defined for thermal boundary conditions

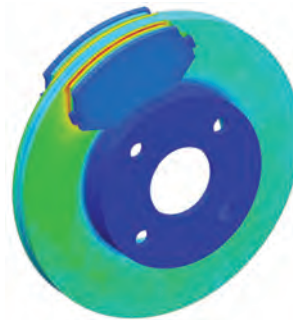

Simcenter 3D Advanced Thermal

Simcenter 3D Advanced Thermal provides a wide range of methods for sophisticated radiation analysis, advanced optical properties, radiative and electrical heating models, one-dimensional hydraulic network modeling and advanced material models such as phase change, charring and ablation. Thermal control devices and articulation may also be modeled.

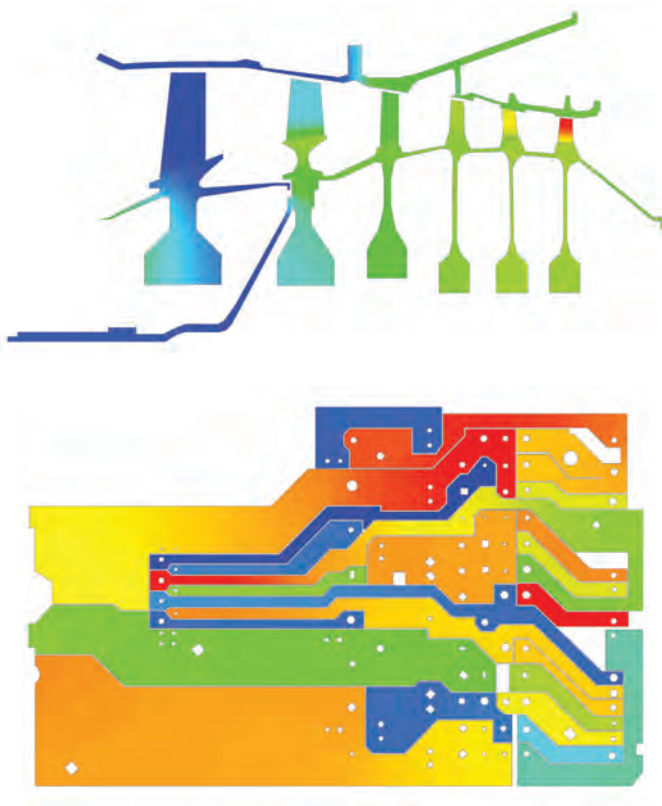

Module benefits

Solve complex heat transfer phenomena with a comprehensive set of modeling tools

Extend thermal solution capabilities in Simcenter 3D Thermal and Simcenter 3D Electronic Systems Cooling

Leverage open architecture to integrate user subroutines and grant greater control over the solution

Use parallelized thermal solver and view factor calculations to increase solution efficiency and reduce total run time

Key features

Simulate direction-dependent optical properties, bi-directional reflectance distribution function (BRDF)

Wavelength-dependent properties for nongray bodies

Advanced radiation methods such as deterministic and Monte Carlo ray tracing and nongray multiband radiative heat transfer

Simcenter 3D Space Systems Thermal

Simcenter 3D Space Systems Thermal is the vertical application that provides a comprehensive set of tools to perform orbital thermal analyses in the Simcenter 3D environment. Simcenter 3D Space Systems Thermal helps resolve engineering challenges early in the design process and is a valuable tool for predicting and understanding thermal physics for space-bound, orbiting and interplanetary vehicles.

Module benefits

Predict thermal performance for orbiting vehicles accurately and quickly

Increase collaboration and team productivity with a thermal analysis solution that is easily integrated with your design and engineering process

Maximize process efficiency with a highly automated solution that requires no additional input files and carries out the analysis in a single pass

Key features

Model orbital heating for all planets of the solar system

Transient view factor recalculations with articulating geometries such as sun-tracking solar panels and directional antennas

Multilayer shell formulation for modeling multilayer insulation, composite panels and thermal protection systems

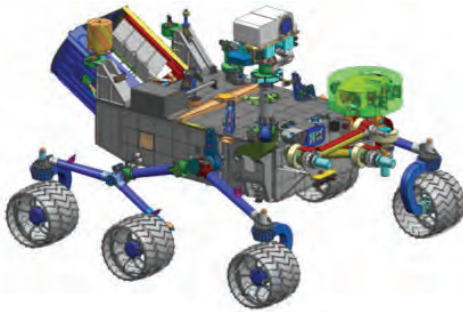

Simcenter 3D Electronic Systems Cooling

Simcenter 3D Electronic Systems Cooling software is an industry-specific vertical application that leverages Simcenter 3D Flow and Simcenter 3D Thermal solvers as well as NX™ software and the NX PCB Exchange module capabilities in an integrated multiphysics environment. This enables you to simulate 3D airflow and thermofluid behavior in densely packed, heat-sensitive electronic systems.

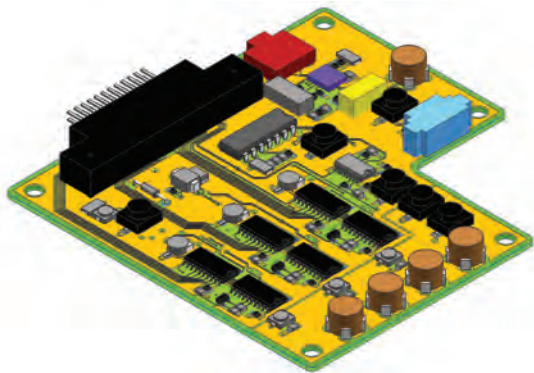
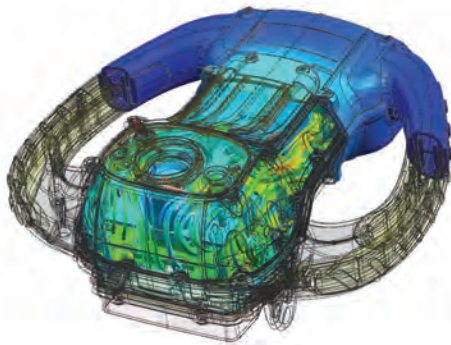

Module benefits

Simulate 3D airflow and thermal behavior in electronic systems

Minimize tedious rework and modeling errors with direct interfaces to electrical computer-aided design (ECAD) systems

Transport condensation, humidity and dust particles in electronics systems

Key features

With NX PCB Exchange, fully three-dimensional board designs can be obtained from the leading printed circuit board (PCB) and flexible printed circuit (FPC) layout software packages from companies such as Siemens Digital Industries Software, Zuken, Cadence and Altium

Radiation enclosures using hemicube-based view factor calculations (using graphics card hardware)

A catalog of fan curves is available out-of-the-box (OOTB), which can be extended with additional manufacturer data

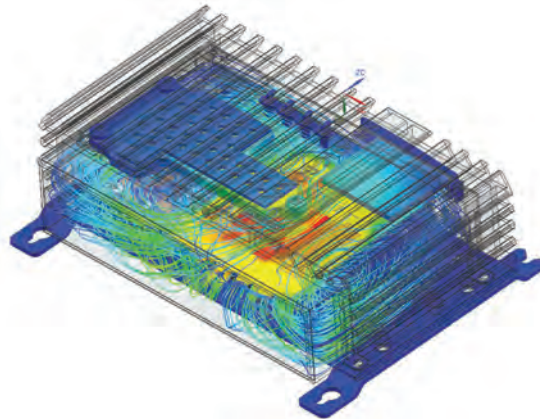

Simcenter 3D Thermal HPC

Simcenter 3D Thermal high-performance computing (HPC) leverages hardware systems configured as a multiprocessor desktop or a multi-node cluster. One license of Simcenter 3D Thermal HPC together with the prerequisite solver licenses can be used to produce a solve over as many processors as available.

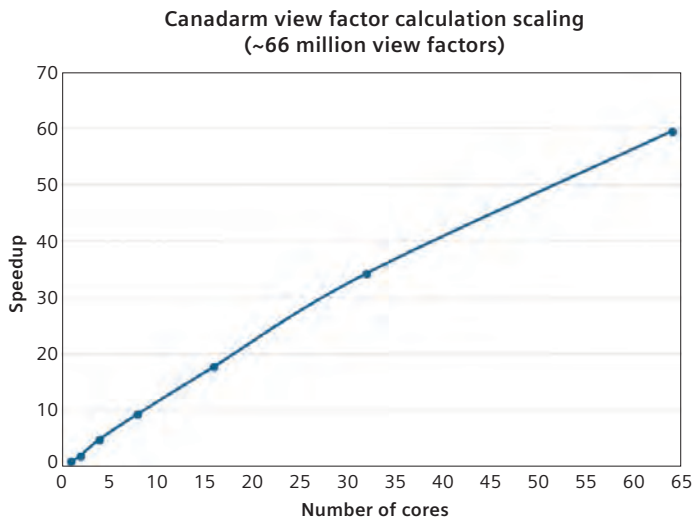

Module benefits

Leverage the flexibility of solving on a single machine or across a distributed network or cluster

Maximize the value of your hardware investments and greatly improve your solution

Key features

Cores may be co-located on a single workstation, distributed over a local area network (LAN), or exist within a standalone computational cluster

Limitations on the maximum number of cores are eliminated, allowing solve speeds to scale up or down based on the number of available cores, not the number of available licenses

Domain decomposition techniques are included for solving large-scale thermal models

The Simcenter 3D Thermal solver features parallel computation of radiation view factors, radiative heating and a solution for the thermal model

Capabilities chart

General capabilities	Specific capabilities	Simcenter 3D Thermal	Simcenter 3D Advanced Thermal	Simcenter 3D Space Systems Thermal	Simcenter 3D Electronic Systems Cooling	Simcenter 3D Thermal HPC
Solver(s)	DMP thermal parallel processing	+	+	+	+	•
	Thermal parallel processing (serial solver)		•	•	•	•
	Multiphysics solve		+	+		•
	Multithreading		•	•	•	
	User subroutine		•	•	•	
File export	cgns				•	
	esatan			•		
	INPF	•		•	•	
	Mapping constraint	•		•	•	
	primitive			•		
	Sinda-85			•		
File import	cgns				•	
	I-DEAS scratch file	•		•	•	
	INPF	•		•	•	
	NX xml	•		•	•	
	plot3d				•	
	primitive			•		
	Universal	•		•	•	
Modeling objects	Ablation charring		•	•		
	Active heater controller		•	•	•	
	Advanced parameters flow				•	
	Advanced parameters thermal	•		•	•	
	Axisymmetry source zone (multiphysics only)	•		•		
	Convection properties				•	
	Duct convection correction		•	•		
	Duct head loss		•	•		
	External conditions				•	
	External solver					
	Fan speed controller				•	
	Generic entity	•		•	•	
	Joint		•	•		
	Joint orbital tracker			•		
	Layer	•		•	•	
	Monte Carlo settings		•	•	•	
	Multiphysics thermal output request					

General capabilities	Specific capabilities	Simcenter 3D Thermal	Simcenter 3D Advanced Thermal	Simcenter 3D Space Systems Thermal	Simcenter 3D Electronic Systems Cooling	Simcenter 3D Thermal HPC	
Modeling objects (continued)	Nongeometric element	•		•	•		
	Orbit			•			
	PCB layer			•	•		
	PCB via			•	•		
	Planar head loss				•		
	Reference temperature	•		•	•		
	Rotational periodicity source zone (multiphysics only)	•		•			
	Target temperature	•		•	•		
	Target temperature change	•		•	•		
	Thermal parameters (multiphysics only)	•		•			
	Thermal source zone	•		•			
	Thermo optical properties	•		•	•		
	Thermo optical properties advanced		•	•			
	Thermo optical properties state		•	•			
	Thermostat	•		•	•		
	Void NGE		•	•			
	Loads	Gravity (component, magnitude and direction)		•	•		
		Rotation (model subset and whole model)		•	•		
		Thermal convecting zone		•	•		
		Thermal loads (heat load, heat flux, heat generation)	•		•	•	
Thermal stream			•	•			
Thermal void (with regions)			•	•			
Constraint	Association target zone	•			•		
	Convection to environment	•		•	•		
	Initial conditions	•	•	•	•		
	Film cooling		•				
	Flow mapping target set				•		
	Mapping	•		•	•		
	Rotational periodicity target zone	•		•	•		
	Simple environment radiation	•		•	•		
	Symmetry target zone	•		•	•		
	Temperature	•		•	•		
	Transverse gradient target set	•			•		

General capabilities	Specific capabilities	Simcenter 3D Thermal	Simcenter 3D Advanced Thermal	Simcenter 3D Space Systems Thermal	Simcenter 3D Electronic Systems Cooling	Simcenter 3D Thermal HPC
Simulation objects	Advanced thermal coupling		•	•		
	Convection coupling		•	•		
	Deactivation set	•		•		
	Deactivation set advanced		•	•	•	
	Disjoint fluid mesh pairing				•	
	Duct flow boundary condition		•	•	•	
	Flow blockage				•	
	Flow boundary condition					
	– Convective outflow				•	
	– Inlet				•	
	– Internal fan				•	
	– Opening				•	
	– Outlet				•	
	– Recirculation loop				•	
	– Static pressure				•	
	Flow surface				•	
	Free molecular heating			•		
	Immersed boundary				•	
	Interface resistance	•		•	•	
	Joule heating (current, electrical coupling, voltage)		•	•	•	
	Merge set			•		
Orbital heating			•			
Override set - thermal properties	•	•	•	•		
Particle injection						

General capabilities	Specific capabilities	Simcenter 3D Thermal	Simcenter 3D Advanced Thermal	Simcenter 3D Space Systems Thermal	Simcenter 3D Electronic Systems Cooling	Simcenter 3D Thermal HPC
Simulation objects (continued)	PCB component				•	
	Peltier cooler		•	•	•	
	Printed circuit board				•	
	Radiation (all radiation and enclosure radiation)	•		•	•	
	Radiation thermal coupling (gap and object-to-object)	•		•	•	
	Radiative element subdivision		•	•		
	Radiative heating		•	•		
	Report	•		•	•	
	Screen				•	
	Selective results				•	
	Solar heating		•	•		
	Solar heating space		•	•		
	Solid motion effects (articulation, spinning)		•	•		
	Symmetry plane				•	
	Thermal coupling	•		•	•	
	Thermal rotational periodicity		•	•		
	Catalogs	Advanced parameters	•		•	•
Component					•	
Correction			•	•		
Fan catalogs					•	
Fan curves					•	

Legend:

- = included in module
- + = additional product required

Note: Simcenter 3D Engineering Desktop is a minimum prerequisite for all Simcenter 3D products. Other dependency or prerequisites may apply for individual products.

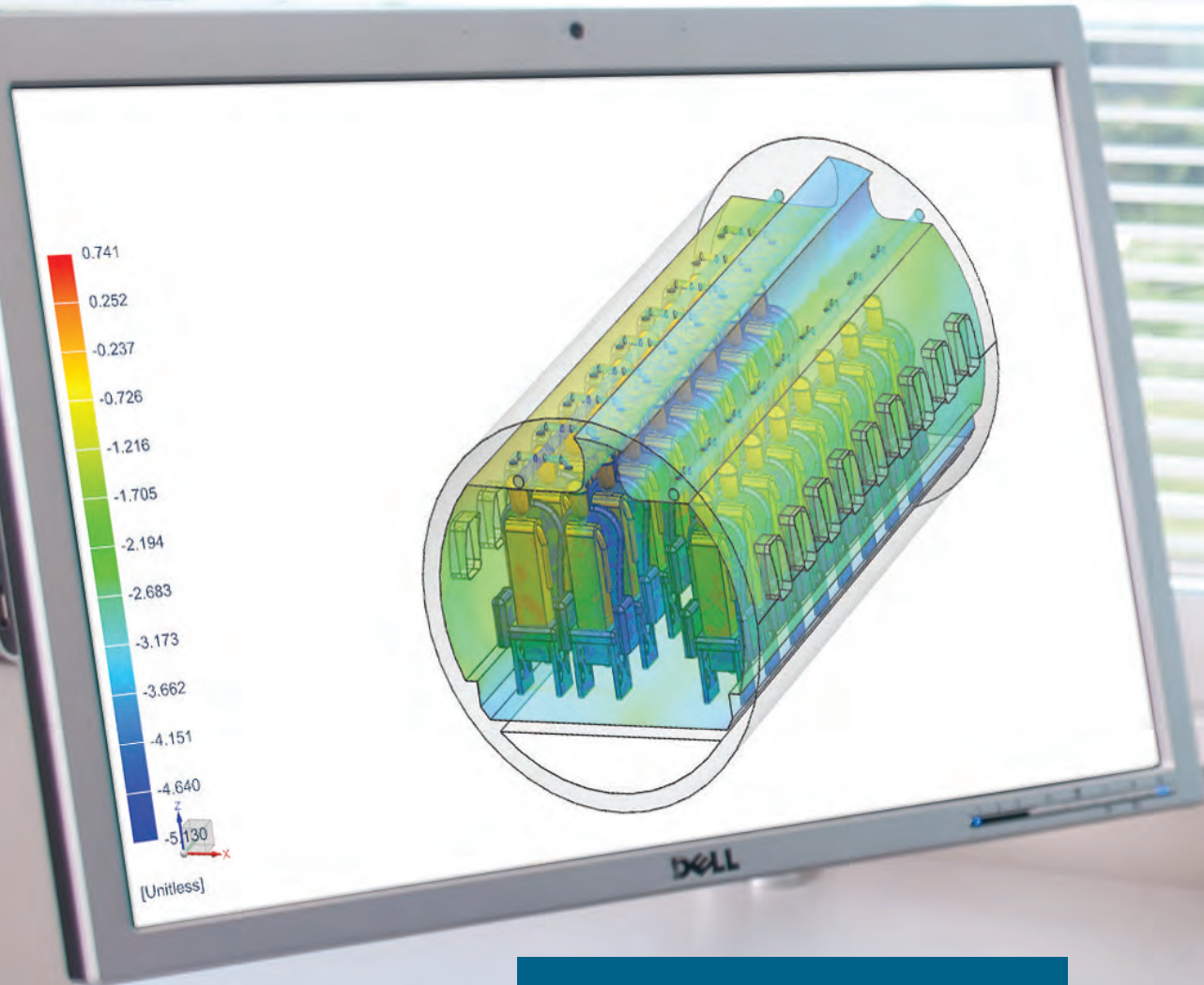

Siemens Digital Industries Software

Simcenter 3D for fluid dynamics simulation

Providing insight for flow in complex assemblies



Solution benefits

- Accurately solve the Navier-Stokes equations that describe fluid motion
- Speed up the preprocessing time for CFD analysis by rapidly creating fluid domain geometry and meshes from complex assemblies
- Achieve faster CFD results by using a consistent environment that allows you to quickly move from design to advanced CFD results
- Couple 1D to 3D flow submodels to efficiently simulate complex systems
- Integrate CFD solution with the broader Simcenter 3D platform to streamline simulation processes by 70 percent
- Speed solution time using parallel flow calculations

Simcenter™ 3D software offers a comprehensive set of sophisticated tools to model and simulate fluid flow for complex parts and assemblies. The integrated computational fluid dynamics (CFD) solution enables fast and accurate fluid-flow simulation and provides insight into product performance during all design development phases, limiting costly, time-consuming physical testing cycles.

A powerful and robust CFD solver

Siemens Digital Industries Software's Simcenter 3D fluid dynamics modules combine the power and accuracy of the well-established control-volume formulation with cell-vertex formulation to discretize and efficiently solve the fluid motion describing Navier-Stokes equations. The Simcenter 3D fluid dynamics solver employs a robust algebraic multigrid solution scheme in combination with multiple first and second order discretization options and time integration schemes to deliver a capable and fully integrated CFD solution. Within the Simcenter environment, it also uses an immersed boundary, flux-based halo-node approach for quick and easy thermal-flow evaluation.

Simcenter 3D for fluid dynamics simulation

Rapidly create fluid domains

Automatically and rapidly extracting fluid domains using traditional Boolean operations, surface wrapping and defining immersed bodies helps improve CFD analysis productivity. Treating dissimilar fluid meshes at interfaces between parts allows the user to quickly investigate many what-if simulation scenarios involving complex assemblies.

A strong coupling with thermal solver

The flow and thermal modules of Simcenter 3D can be seamlessly coupled. CFD and thermal models can be created separately and then combined by simply dragging and dropping the boundary conditions into the coupled simulation. This provides a powerful and easy-to-use solution for applications that require explicit modeling of CFD along with detailed thermal analysis.

A dedicated tool for electronics system cooling

Simcenter 3D Electronic Systems Cooling provides a fully associative end-to-end electronics thermal design capability. Changes in the electronics computer-aided design (ECAD) can be seamlessly propagated to the thermal/CFD model to recover the new system temperatures and airflows.

Providing a platform for multidiscipline simulation

The Simcenter 3D fluid dynamics solution is part of a larger, integrated multidiscipline simulation environment with the Simcenter 3D Engineering Desktop at the core for centralized pre-/postprocessing for all Simcenter 3D solutions. This integrated environment helps you to achieve faster CAE processes and streamline multidiscipline simulations that integrate flow and other disciplines like aero-vibro-acoustics that requires acoustics and structural solution, fluid-structure interaction or thermal coupled problems that require thermal solutions.

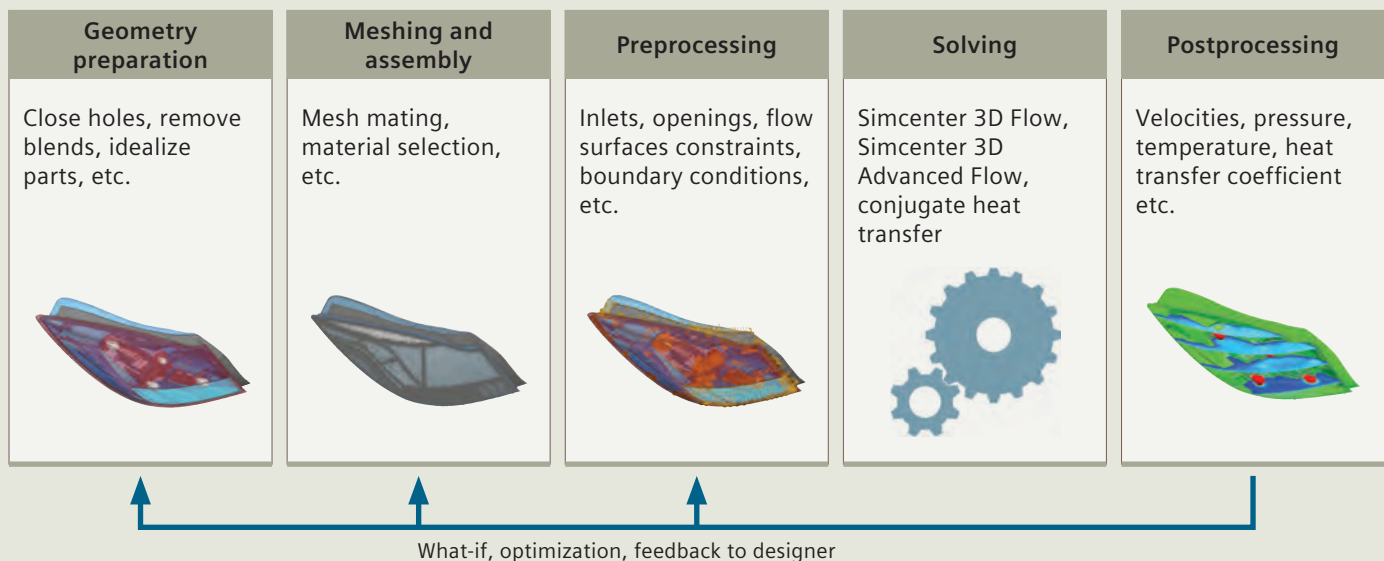
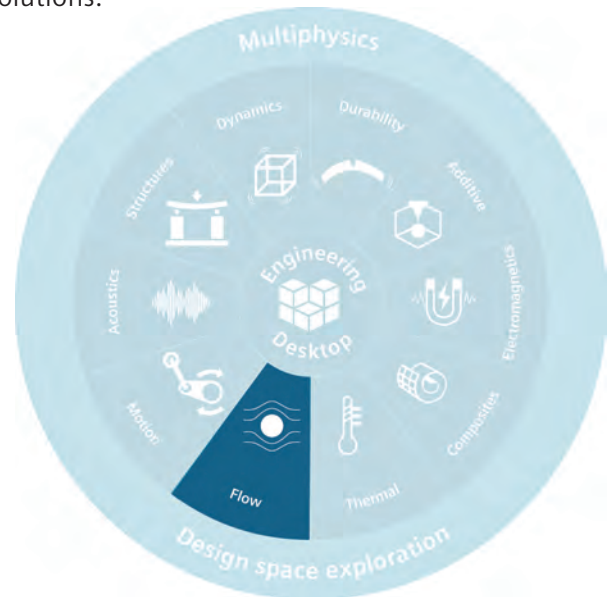

Industry applications

From the gust of air that pushes a sailboat to the hot exhaust exiting an automobile’s tailpipe to the burst of medication issuing from the nozzle of an oral inhalation device, fluid dynamics are an essential and inextricable part of industry applications.

Automotive and transportation

Simcenter 3D provides porous blockage models for a quick and effective simulation of under-hood components like radiators, charge air coolers and condensers. Further automotive applications include thermal management in automotive lighting systems, cabin comfort and humidity analysis, gas mixture modeling of exhaust and pollutant species transport.

Aerospace and defense

Transporting humidity along with film condensation modeling, the flow simulation capabilities of Simcenter 3D can be used to obtain estimates of passenger comfort. Lift and drag forces can be computed and reported, based on the pressure and viscous shear acting on flow surfaces. The fluid dynamic forces can be automatically mapped to structural solutions.

Electronics and consumer goods

Critical thermal design issues such as open and closed electronics enclosures can be addressed using Simcenter 3D flow modules, which offer a complete solution for the thermal design of electrical and electronics systems. Humidity and film condensation on electronics components can be readily simulated.

Industrial machinery

Flow in rotating machinery can be modeled using the rotating frame of reference methods. Mold cooling simulations can be performed, including forced/free convection and non-Newtonian material behavior, flow in porous filters and heavy-particle-laden flow. Two-phase flow conditions, with constituents having significantly different densities and viscosities, are also supported.

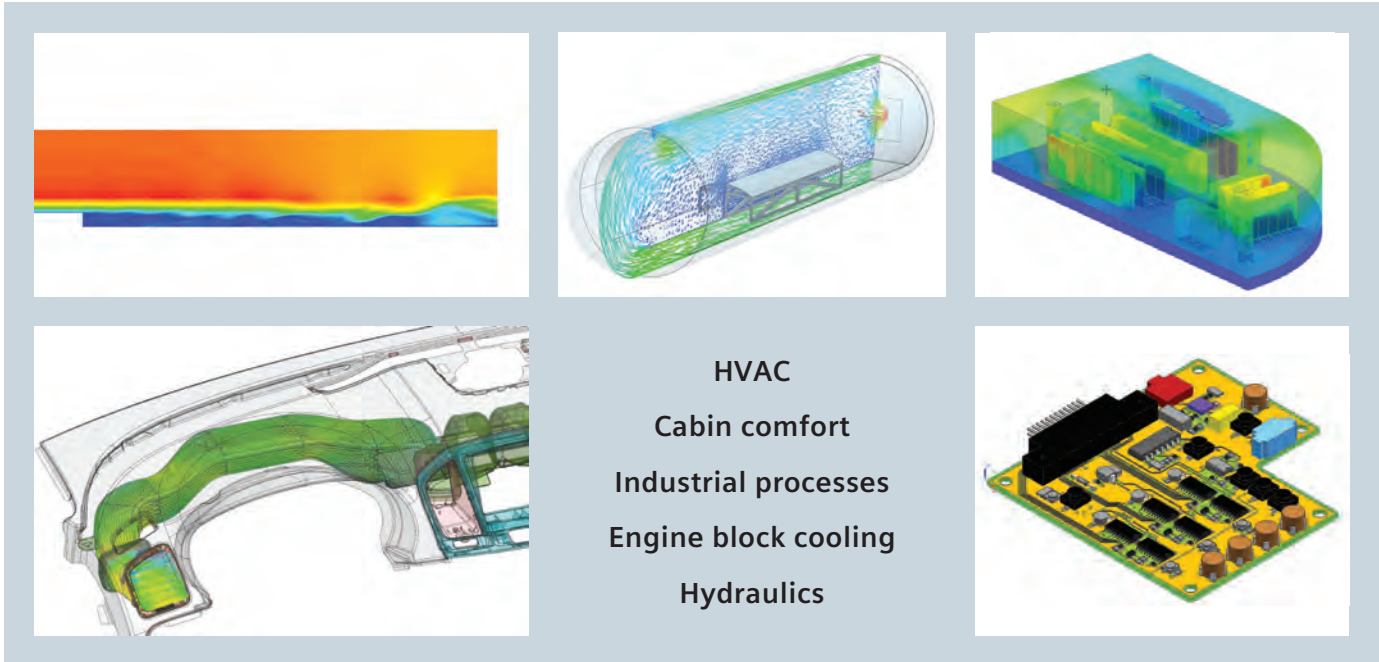

HVAC
 Cabin comfort
 Industrial processes
 Engine block cooling
 Hydraulics

Simcenter 3D Advanced Fluid Modeling

Simcenter 3D Advanced Fluid Modeling delivers state-of-the-art tools to rapidly and efficiently create complex fluid models used for either CFD or acoustic simulations. Simcenter 3D Advanced Fluid Modeling enables you to create fluid domain geometry from complex component or assembly models along with specialized boundary layer meshing capabilities that deliver accurate results.

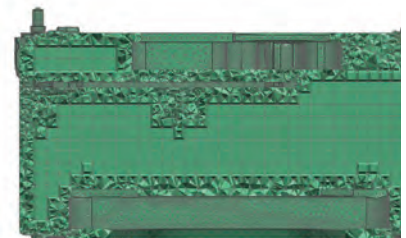
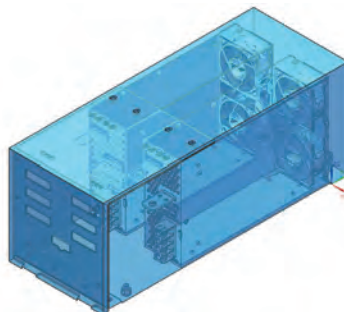
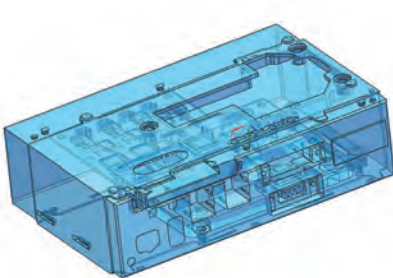
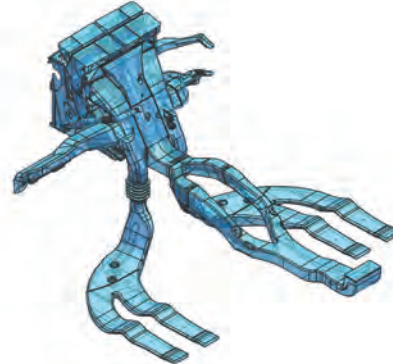
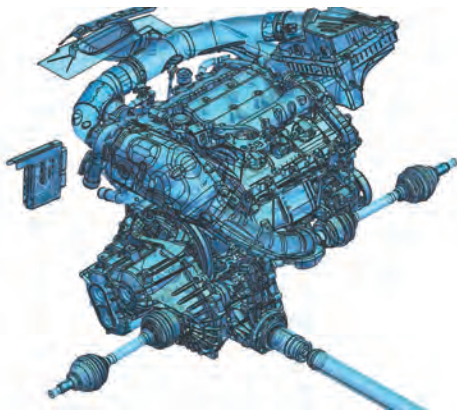

Module benefits

Reduces time spent creating meshes for CFD and acoustic simulations

Rapidly creates fluid domain geometry from complex assemblies

Accurately meshes fluid domain and boundary layers

Supports full-assembly to extract air volume in complex systems as well as mesh assemblies

Key features

Enables fast and intuitive direct geometry editing using synchronous technology

Creates an airtight envelope based on the selected geometry or mesh using an advanced surface wrapping algorithm

Delivers a complete set of tools to define the boundary layer mesh and ensures optimal wall-adjacent meshes for turbulence modeling

Provides hybrid hex-tet meshing with a significant number of structured elements

Simcenter 3D Flow

Simcenter 3D Flow is a CFD solution that provides sophisticated tools to model and simulate fluid flow for complex parts and assemblies. Simcenter 3D Flow combines the power and accuracy of the well-established control-volume formulation with cell-vertex formulation to discretize and efficiently solve the fluid motion described by the Navier-Stokes equations.

Module benefits

- Reduce costly physical prototypes by simulating fluid flow in a virtual environment
- Streamline processes that require a multidisciplinary simulation approach
- Save time and avoid errors due to transfer of data and results for multiphysics simulation

Key features

- Simulate internal- or external-flow problems in turbulent, laminar and mixed flows
- Account for forced, natural and mixed convection
- Connect dissimilar fluid meshes at interfaces between complex assemblies

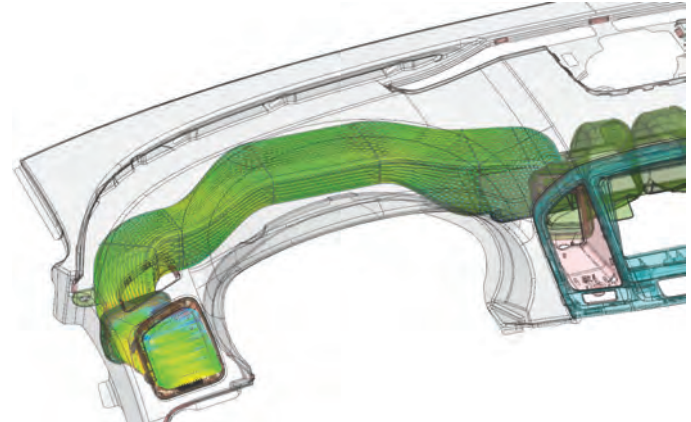
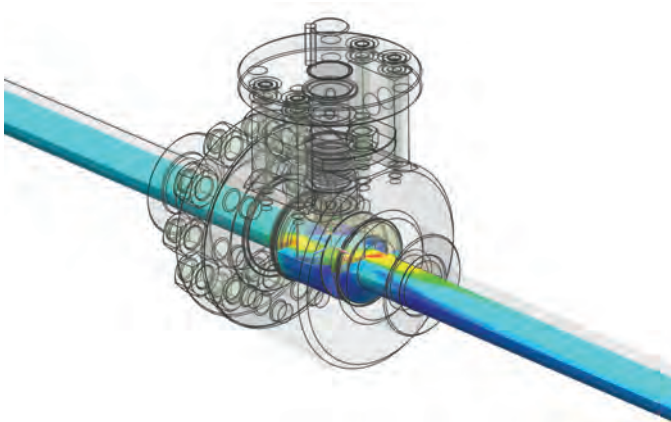

Simcenter 3D Advanced Flow

Simcenter 3D Advanced Flow is an add-on module to both Simcenter 3D Flow and Simcenter 3D Electronic Systems Cooling. It extends the flow-simulation capabilities of these products to encompass internal or external fluid flow, including compressible and high-speed flows, non-Newtonian fluids, tracking of heavy particles and multiple rotating frames of reference.

Module benefits

Readily track the interface between two fluids in a sloshing problem

Efficient and accurate rotating machinery simulation

Couple 1D hydraulic networks with 3D flow models to simulate complex systems

Key features

Single and multiple rotating frames of reference

Additional turbulence models such as RNG k-epsilon, Realizable k-epsilon, SST, k-omega and LES

Multi-species filling and emptying

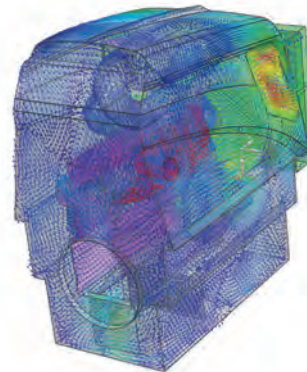
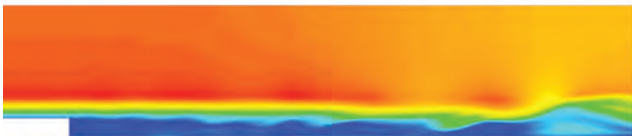
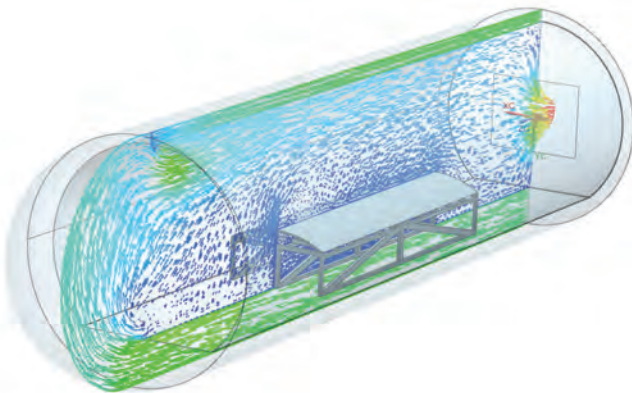

Simcenter 3D Flow HPC

Simcenter 3D Flow high-performance computing (HPC) makes use of hardware systems configured as a multi-processor desktop or a multi-node cluster. One license of Simcenter 3D Flow HPC together with the prerequisite solver licenses can be used to produce a solve over as many processors as available.

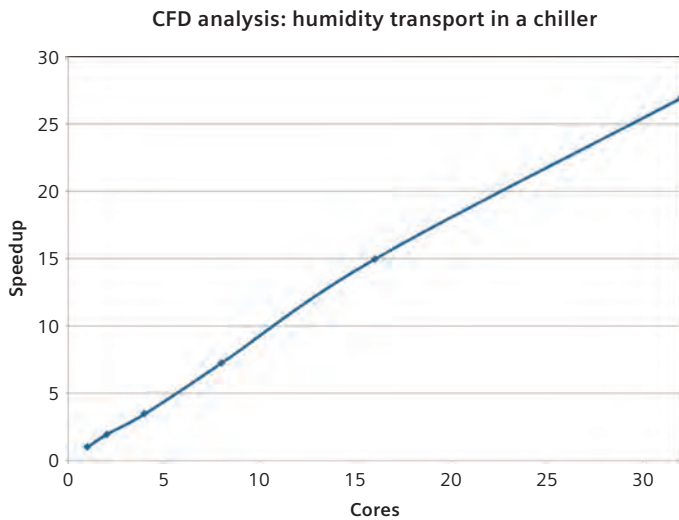

Module benefits

Enjoy the flexibility of solving on a single machine or across a distributed network or cluster

Maximize the value of your hardware investments and greatly improve your solution

Key features

Cores may be co-located on a single workstation, distributed over a local area network, or exist within a standalone computational cluster

Limitations on the maximum number of cores are eliminated, allowing solve speeds to scale up or down based on the number of available cores, not the number of available licenses

Domain decomposition techniques are included for solving large-scale flow models

Capabilities chart

General capabilities	Specific capabilities	Simcenter 3D Advanced Fluid Modeling	Simcenter 3D Flow	Simcenter 3D Advanced Flow	Simcenter 3D Flow HPC
Solver(s)	DMP flow parallel processing		+	+	•
	Flow parallel processing (serial solver)			•	•
	Multiphysics solve		+	+	•
	Condensation and evaporation			•	
File export	cgns		•		
	INPF		•		
	Mapping constraint		•		
File import	cgns		•		
	I-DEAS scratch file		•		
	INPF		•		
	NX xml		•		
	Universal		•		
Advanced fluid modeling required during solve as well	3D Hybrid mesh	•			
	Constraint - auto refinement	•			
	Constraint - contact prevention	•			
	Constraint - local resolution	•			
	Boundary layer mesh control	•			
	CGNS import / export	•			
	PLOT3D import	•			
	Sim fluid domain SSSO	•			
	Sim fluid domain mesh	•			
	Recipe create (output body)	•			
	Recipe create (output body + 2D mesh)	•			
	Recipe create (output 2D mesh)	•			
	Recipe create from 2D element faces	•			
	Tet Mesh (with BL mesh control)	•			
	WRAP (output body)	•			
	WRAP (output body + 2D mesh)	•			
	WRAP (output 2D mesh)	•			
	WRAP recipe with constraints	•			
	WRAP recipe from 2D element faces	•			

General capabilities	Specific capabilities	Simcenter 3D Advanced Fluid Modeling	Simcenter 3D Flow	Simcenter 3D Advanced Flow	Simcenter 3D Flow HPC	
Solution attributes and parameters	Fixed turbulent viscosity		•			
	Standard K-epsilon		•			
	RNG K-epsilon			•		
	Realizable K-epsilon			•		
	K-Omega turbulence model			•		
	LES-Large eddy simulation			•		
	Mixing length			•		
	Laminar flow			•		
	Spalart-Allmaras				•	
	Shear stress transport				•	
	Modeling objects	Advanced parameters flow		•		
		Convection properties		•		
		Duct convection correction				•
		Duct head loss				•
		External conditions			•	
		Fan speed controller				•
Generic entity				•		
Homogeneous gas mixture					•	
Immiscible fluid mixture					•	
Non-Newtonian fluid					•	
Planar head loss				•		
Thermostat				•		
Loads	Tracer fluid			•		
Thermal loads (heat load, heat flux, heat generation)			•			
Constraint	Association target zone		•			
	Initial conditions		•	•		
	Flow mapping target set		•			
	Mapping		•			
	Temperature		•			

General capabilities	Specific capabilities	Simcenter 3D Advanced Fluid Modeling	Simcenter 3D Flow	Simcenter 3D Advanced Flow	Simcenter 3D Flow HPC
Simulation objects	Convection coupling			•	
	Deactivation set		•		
	Deactivation set advanced				
	Disjoint fluid mesh pairing		•		
	Duct flow boundary condition			•	
	Flow blockage (porous, isotropic, orthotropic, solid)		•		
	Flow boundary condition				
	– Bursting membrane				•
	– Convective outflow			•	
	– Flap				•
	– Inlet			•	
	– Internal fan			•	
	– Opening			•	
	– Outlet			•	
	– Recirculation loop			•	
	– Static pressure			•	
	Flow surface (boundary and embedded, with obstructions)			•	
	Fluid domain (fluid mesh and surface mesh)	•			
	Immersed boundary	•	•		
	Mixing plane (disjoint and joint)				•
	Moving frame of reference (rotating and translating)				•
	Particle injection				•
	Peltier cooler				
	Periodic boundary condition (rotational and translational)				•
	Report			•	
Screen			•		
Selective results			•		
Supersonic inlet				•	
Symmetry plane			•		



General capabilities	Specific capabilities	Simcenter 3D Advanced Fluid Modeling	Simcenter 3D Flow	Simcenter 3D Advanced Flow	Simcenter 3D Flow HPC
Catalogs	Advanced parameters		•		
	Correction			•	
	Fan curves		•		

Legend:

- = included in module
- + = additional product required

Note: Simcenter 3D Engineering Desktop is a minimum prerequisite for all Simcenter 3D products. Other dependency or prerequisites may apply for individual products.

SIEMENS

Ingenuity for life

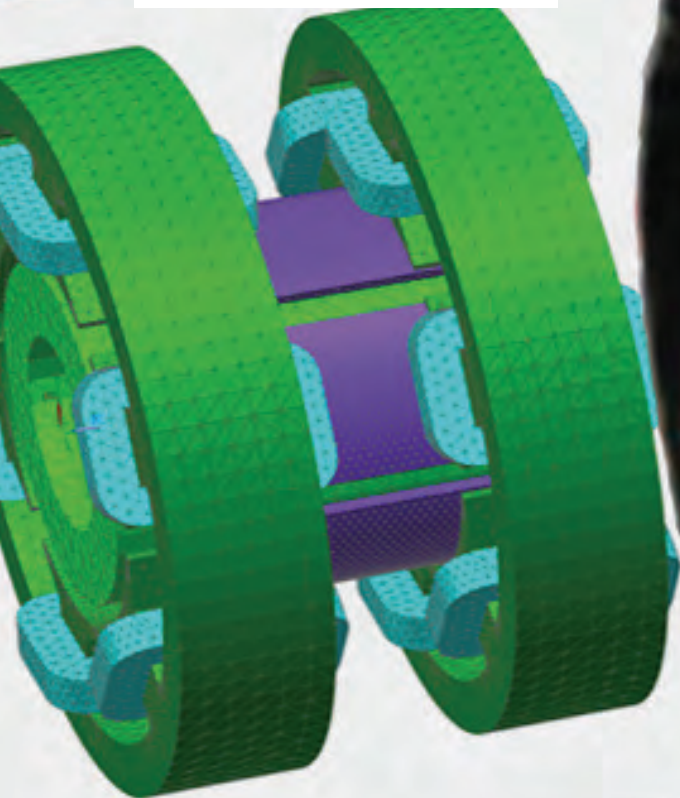

Siemens Digital Industries Software

Simcenter 3D for electromagnetics simulation

Integrating Simcenter MAGNET and high-frequency EM solvers to achieve excellent electromagnetic performance

[siemens.com/simcenter3d](https://www.siemens.com/simcenter3d)

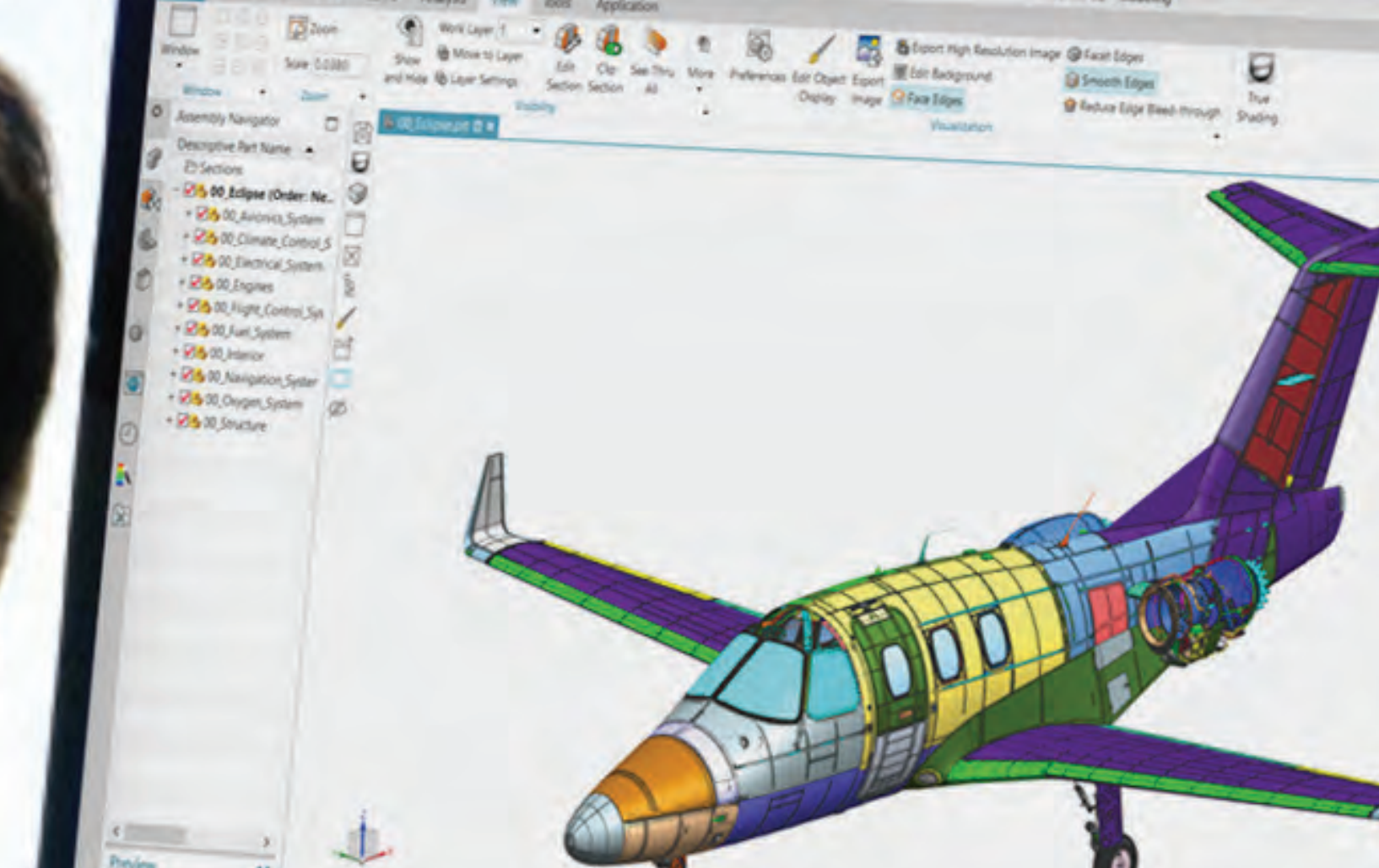

Solution benefits

- Enable low- and high-frequency electromagnetics simulation in a multidiscipline integrated environment
- Manage and simulate multiscale models of the highest complexity in a reasonable amount of time
- Use advanced algorithms to enhance readily available material data for high-fidelity simulations
- Use integrated EM-thermal solvers to predict permanent magnets' demagnetization and hot spots for increased robustness

Simcenter™ 3D software for electromagnetics (EM) offers an integrated, low-frequency solver with Simcenter MAGNET™ software and a variety of high-frequency solvers for wave propagation challenges. The comprehensive set of capabilities provides insight into diverse design challenges: performance of electromechanical components and energy conversion, antenna design and siting (small to large scale), electromagnetic compatibility (EMC) and electromagnetic interference (EMI).

Analyze large scale, system-level problems efficiently

Siemens Digital Industries Software's Simcenter 3D for electromagnetics integrates capabilities that can generate, manage and simulate multiscale models of the highest complexity in a reasonable amount of time and with minimal computational resources. There are efficient and effective methods tuned for each frequency/time range, application field and scale of device.

Simcenter 3D for electromagnetics simulation

Dedicated and robust electromagnetic solvers

Simcenter 3D for electromagnetics is designed for robustness and computational efficiency. A range of dedicated solvers (time and frequency based; linear and nonlinear, finite and boundary element based) with novel boundary conditions and smart mesh refinements offers a transformative computer-aided engineering (CAE) process, with simulations ranging from a fast, initial analysis to inherent realism for final verification.

Further refinement with integrated thermal simulations

Reliable and accurate results can only be obtained when models incorporate the right level of sophistication. Coupling high fidelity electromagnetic and thermal solvers facilitates realistic predictions of the temperature distribution and the corresponding effect on materials and low-frequency electromagnetic fields. This integrated thermal simulation provides further insights, ultimately resulting in reduced risk for demagnetization and performance drop.

Deliver high-fidelity simulations with advanced material models

The Simcenter 3D electromagnetics solution uses advanced algorithms to enhance readily available material data so simulation results strongly correlate with test data and expected performance. These capabilities include modeling manufacturing processes,

temperature dependencies and magnetization imprints. Smart or engineered materials, which have uncommon electromagnetic properties, are modeled with high fidelity.

Providing a platform for multidiscipline simulation

The Simcenter 3D EM solution is part of a larger, integrated multidiscipline simulation environment with centralized pre- and postprocessing for all Simcenter 3D solutions. This integrated environment helps you to achieve faster CAE processes and streamline multidiscipline simulations that integrate electromagnetics and other disciplines like NVH and CFD in order to generate a high fidelity digital twin and examine all core physics for product compliance, safety and performance verification.

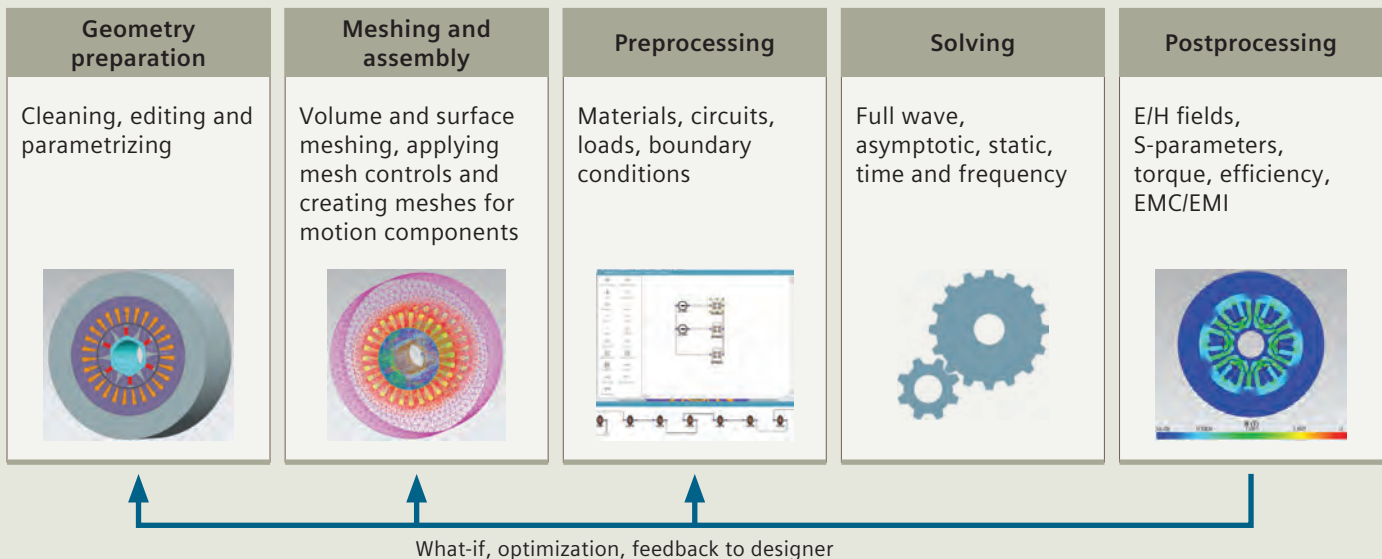
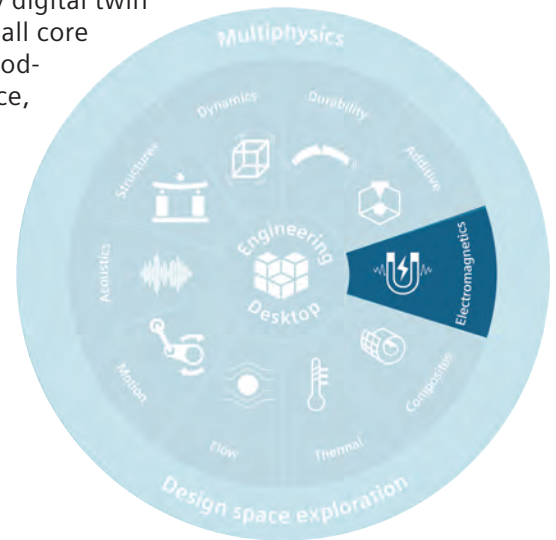

Industry applications

Electromagnetics heavily impacts the safety, performance and reliability of a product, so having a digital twin that can faithfully predict the multiple characteristics of this phenomena is critical for design success.

Automotive and transportation

Simcenter 3D for EM provides the tools for designing electric vehicles (EVs) and hybrid electric vehicle (HEV) powertrains and electromechanical components (pumps, actuators), and verifying electromagnetic emissions (both radiated and conducted) to meet regulations and develop antennas and communication devices for vehicle to vehicle or infrastructure (V2x) connectivity.

Aerospace and defense

Simcenter 3D can tackle the complex large-scale simulations of high-intensity radiated fields and lightning on the fuselage. Also, EMC requirements for avionics can be addressed for the most complex systems. New electric propulsion can be designed with high-end electromagnetic motion solvers.

Marine

Simcenter 3D can provide insight into antenna placement and minimization of radar signature also for aeronautical applications. The performance of propulsion motors, energy storage systems and rails can also be predicted.

Industrial machinery

Simcenter 3D provides the necessary features to evaluate the performance and durability of the electromechanical components used in heavy vehicles, inspection and extraction equipment.

Consumer goods

Simcenter 3D can be used to verify EMC/EMI requirements and hence guarantee proper function of the electronics in all environments. Further, it is used to evaluate the performance of communication systems based on antenna types and provide insight into electromechanical components (motors, pumps, fans) used in home appliances, including wireless charging.

Static, harmonic and transient low frequency field simulations

Coupled EM-thermal and EM-motion solvers

MoM and MLFMA

UTD and IPO

Synthetic antenna models

Surface-partial element equivalent circuit (S-PEEC)

Simulate multiscale models



Simcenter 3D Low Frequency EM

Simcenter 3D Low Frequency EM software allows you to create and edit Simcenter MAGNET models. Using the Simcenter 3D graphical interface, you can import or build 3D electromechanical models in native NX CAD, use and define sophisticated magnetic materials and define properties, boundary conditions and loads, including loads using an integrated 1D circuit modeling tool.

Once solved, the product also allows you to do sophisticated postprocessing of the results.

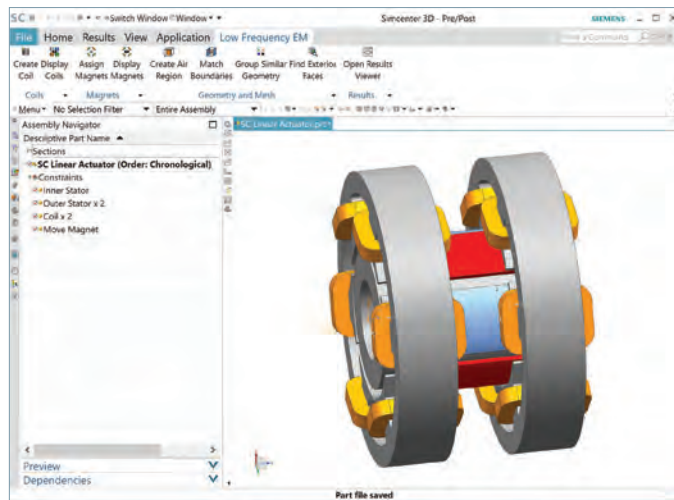

Module benefits

- Associativity between electromagnetic performance and the fully parametrized CAD model
- Highly efficient way of defining complex electromechanical devices
- Integrated world-class material database
- Supports multidiscipline scenarios from the integrated environment

Key features

- From 2D to full 3D detailed analysis
- Includes static, harmonic and transient solvers, including motion for any number of components
- Material models for low-frequency EM materials (advanced models such as hysteresis, de-magnetization)
- Integrated thermal analysis

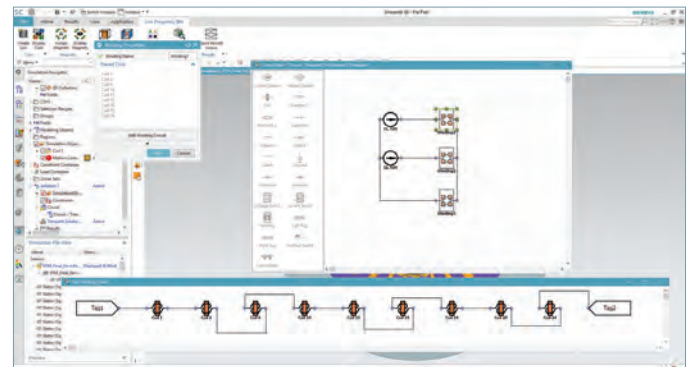

Simcenter MAGNET solver

The Simcenter MAGNET solver is based on low-frequency electromagnetic solving technology, which is built on several decades of expertise, incorporating a wide range of capabilities and technologies for maximum performance for each application. The solver includes static, harmonic, transient solver capabilities including motion. It is designed for motor engineers and electromagnetic engineers who want to improve design and achieve maximal performance and efficiency in their electromechanical systems.

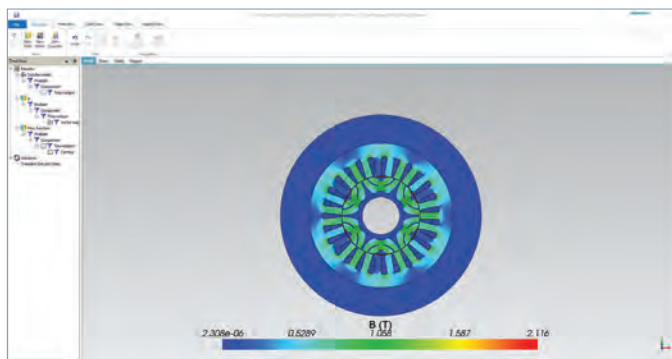
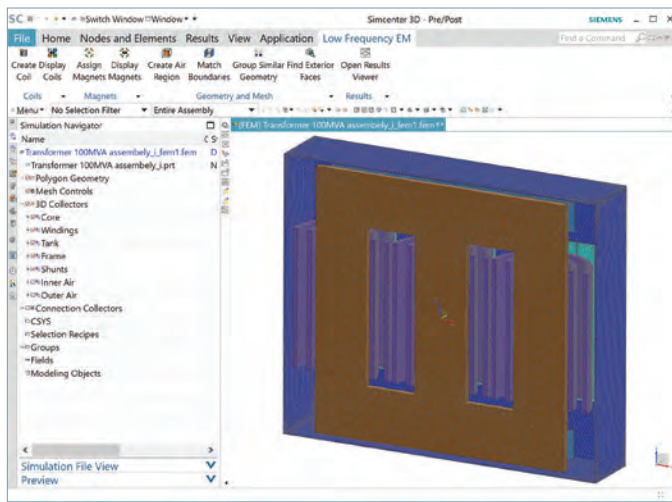

Module benefits

- Achieve great accuracy due to outstanding capabilities
- Fast solvers, adapted and optimized for applications
- Benefit from an extensive electromagnetic materials library

Key features

- From 2D axisymmetric and 2D translational to full 3D models
- From static to harmonic and full transient
- From single component to any number of components with motion
- Sophisticated loss models including iron loss, hysteresis
- Circuit editor for co-simulation

Simcenter MAGNET Thermal solver

The thermal and electromagnetic modules of Simcenter MAGNET can be used to simulate steady-state and transient temperature distribution, considering losses in the windings as well as the core, including the eddy current and hysteresis losses.

Module benefits

- Increase efficiency of electromechanical devices by considering the thermal aspects
- Assess risk of demagnetization of permanent magnets and increase robustness
- Run your models in different operating conditions and easily assess effect of thermal behavior on device performance (torque, efficiency, demagnetization)

Key features

- Coupled thermal-electromagnetics co-simulation
- Steady state
- Transient

Simcenter 3D High Frequency EM

Simcenter 3D High Frequency EM software allows you to create, edit and postprocess high-frequency electromagnetic analyses from the Simcenter 3D graphical interface. The user can define complex materials, element properties, boundary conditions and excitations, including highly performant equivalent antenna models, all while keeping associativity to CAD.

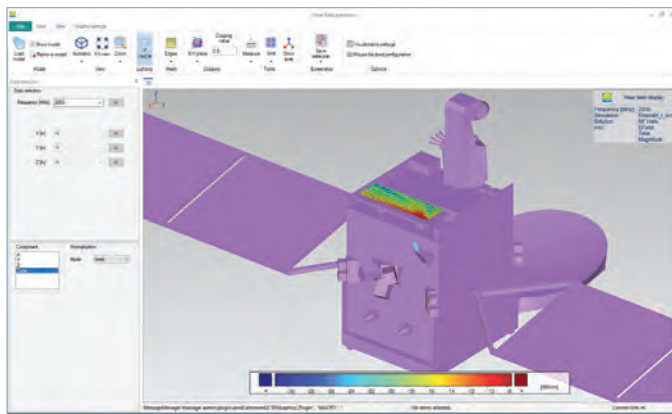
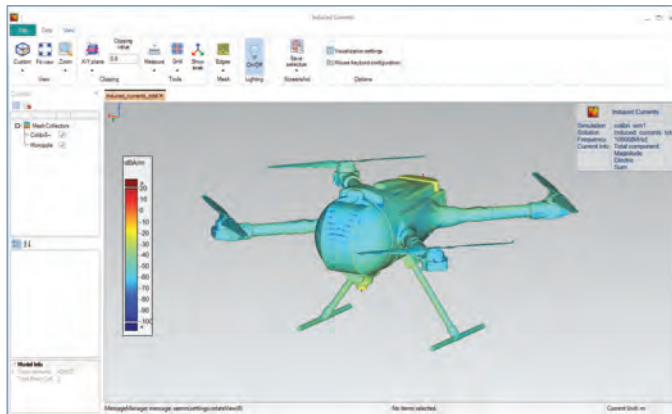

Module benefits

- Enable end-to-end efficient process using associativity between the electromagnetic performance and the CAD model
- Facilitate straightforward handling of large, system-level models such as full aircraft, satellites, ships and cars
- Address a wide frequency spectrum with a range of dedicated solvers
- Leverage existing knowledge built on 30 years of expertise in the high-frequency electromagnetics domain

Key features

- Simcenter 3D environment for high-frequency EM
- Setting up for a range of dedicated solvers: uniform theory of diffraction (UTD), 3D and 2.5D (for devices and antennas based on multilayered PCB technology) accelerated multilevel fast multipole algorithm (MLFMA, DDM...) MoM-based solvers
- Material models for high-frequency electromagnetics
- Postprocessing of analysis: EM fields, SYZ parameters, coupling, far-field and near-field results, magnetic and electric currents, antenna pattern
- CAD based and equivalent models of antenna (antenna modeling starting from incomplete data)

Simcenter High Frequency EM solver

The Simcenter High Frequency EM solver embeds full-wave solvers based on integral methods (MoM and FMLFMA) for solving Maxwell's electromagnetic equations. In addition, asymptotic methods are available based on the UTD and IPO. A variety of solvers are incorporated to efficiently solve for 2.5D as well as for full 3D field problems. Solver acceleration options (Multi-boundary conditions MoM-based algorithms, accelerated through MLFMA, DDM and other fast algorithms) are embedded to speed up computation times for large systems.

Module benefits

- Availability of a wide range of solvers allows you to select the most appropriate one for the job
- Ultra-large-scale problems (large electric size) can be handled
- Run models with different length scales (small antennas integrated in large systems can be handled efficiently)
- Solver accelerators provide extra speed

Key features

- Full wave: MoM, MLFMA and S-PEEC
- Asymptotic: UTD and IPO
- Variety of sources: plane wave, dipole, port excitation, directivity pattern
- Synthetic (equivalent) antenna models
- Multilayer substrates

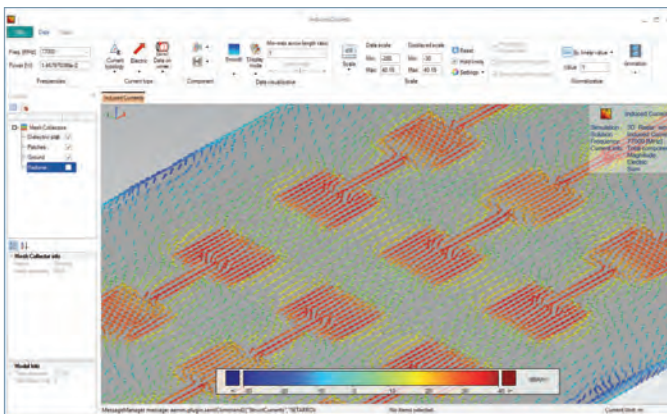
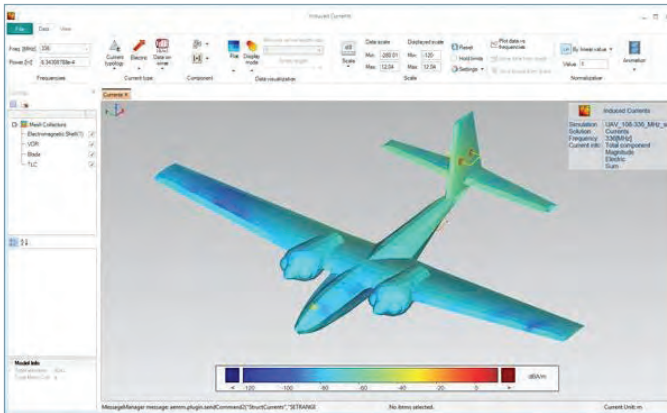

Capabilities chart

General capabilities	Specific capabilities	Simcenter 3D Low Frequency EM	Simcenter MAGNET solver	Simcenter MAGNET Thermal solver
Low-frequency electromagnetics				
Meshing	Automatic airgap remeshing with motion		•	
Boundary condition	Coils definition (body, face)	•		
	Periodic	•		
	Flux tangential	•		
	Field normal	•		
	Thin plate	•		
	Perfect electric insulator	•		
	Surface impedance (linear and nonlinear model)	•		
	Coil excitation (current and voltage driven)	•		
	Circuit (strongly coupled)	•		
	Motion components (velocity and load driven, multiple degrees-of-freedom)	•		
Materials	Material library for low-frequency EM (extensive set of materials)	•		
	Models for low-frequency EM materials (advanced models: hysteresis, demagnetization)	•		
Analysis and solutions	2D axisymmetric		•	
	2D translational		•	
	3D		•	
	Electromagnetic		•	
	Coupled thermal - electromagnetic (steady state or transient thermal)			•
	Coupled thermal - electric field (steady state or transient thermal)			•
	Static		•	
	Transient		•	
Transient with motion		•		
Time harmonic		•		
Post-processing	Field results (B-field, E-field, temperature, etc.)	•		
	Quantities (voltage, current, energy, loss, force, torque, flux-linkage, temperature, heat flow, etc.)	•		
	Motion (magnetic force/torque, load force/torque, position, speed, acceleration, etc.)	•		

General capabilities	Specific capabilities	Simcenter 3D High Frequency EM	Simcenter High Frequency EM solver
High-frequency electromagnetics			
Boundary condition	Electric field integral equation (EFIE)	•	
	Magnetic field integral equation (MFIE)	•	
	Combined field integral equation (CFIE)	•	
	Poggio-Miller-Chang-Harrington-Wu-Tsai (PMCHWT)	•	
	Impedance boundary conditions (IBC) of first and high order	•	
	Network IBC (NIBC) of first and high order	•	
	Thin sheet of first and high order	•	
	Mixed-potential integral equation (MPIE)	•	
Excitation	Port excitation (delta-gap)	•	
	Magnetic and electric dipoles	•	
	Plane wave	•	
	Synthetic antenna models	•	
	SWE (spherical wave expansion)	•	
Materials	3D pattern	•	
	Models for high-frequency EM materials	•	
Solution	PEC, lossy metallic surface, dispersive materials, RAM, bulk dielectrics structure, composite laminate stack up, characterized by measurements	•	
	2.5D frequency domain MoM		•
	3D frequency domain MoM		•
	Surface-partial element equivalent circuit (S-PEEC)		•
	Asymptotic ray based UTD		•
	Asymptotic current-based (iterative physical optics)		•
	Inter-antenna coupling		•
	Fast antenna modeling tools		•
	Reverse sourcing tools		•
	Acceleration methods	Sparse matrix-adaptive integral method (SM-AIM)	
Multi-resolution - multilevel fast multiple algorithm (MLFMA)			•
Fast near-/far-field computation			•
Adaptive cross approximation (ACA)			•
Fast far-field approximation (FaFFA)			•
Hardware: multi graphics processing unit (GPU)		•	



General capabilities	Specific capabilities	Simcenter 3D High Frequency EM	Simcenter High Frequency EM solver
High-frequency electromagnetics (continued)			
Postprocessing	Port parameters (SYZ , etc.)	•	
	Inter-antenna coupling	•	
	Port impedances	•	
	Induced currents	•	
	Far-field	•	
	Near-field	•	

Note: Simcenter 3D Engineering Desktop is a minimum prerequisite for all Simcenter 3D products. Other dependency or prerequisites may apply for individual products.

SIEMENS

Ingenuity for life

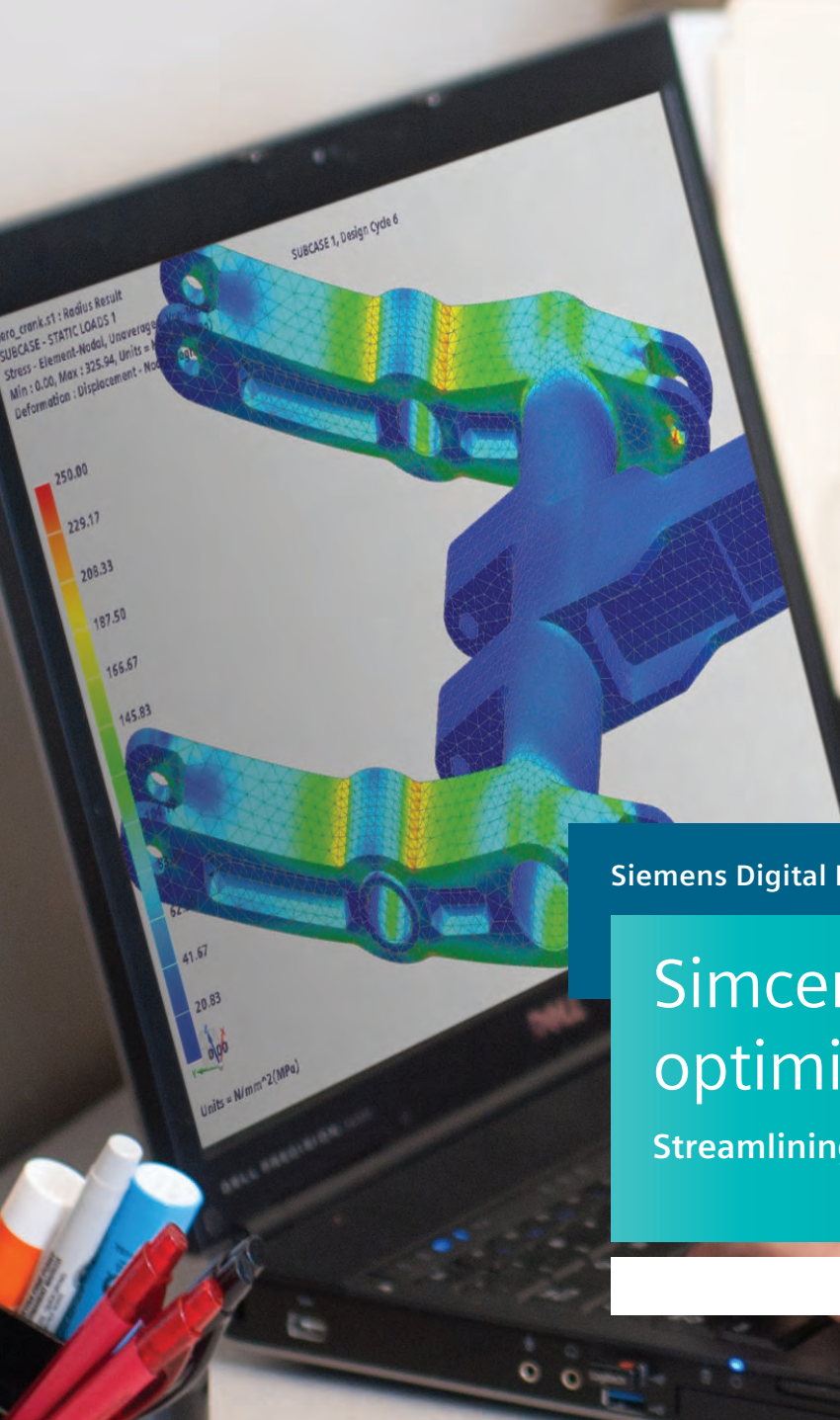

Siemens Digital Industries Software

Simcenter 3D for optimization

Streamlining the design exploration process

[siemens.com/simcenter3d](https://www.siemens.com/simcenter3d)



Solution benefits

- Discover a better design faster
- Eliminate model simplification, model fitting or surrogates
- Eliminate design overhead and achieve significant productivity gains
- Reduce research time, product development costs and product design risks
- Support design reviews by providing sensitivity to design variable

Simcenter™ 3D software optimization solutions relieve the burden of improving product designs by automating the iterative process. This enables you to compare your design's performance against specifications. It enables you to start at topology optimization and extend to design space exploration with more classical parametric optimization capabilities.

Automating the product performance process

Simcenter 3D optimization solutions streamline and automate that process by using sophisticated algorithms to search the entire design space and find the right combination of parameters that will yield optimal design and performance. To help the program know what you mean by optimal, you specify design and performance objectives for characteristics such as



Simcenter 3D for optimization

minimum weight, shape constraints and minimum stress or strain. Design parameters that you can vary include geometric, material and connectivity properties.

Reduce design risk and accelerate innovation

By better understanding the complex relationships among design parameters and how changes affect them, you can gather insight into product performance risk and accelerate innovation by determining feasible designs that satisfy all requirements.

Shorten time-to-market with confidence

Analyze your product performance deviations from specifications in a variety of operating conditions, and shorten time-to-market by automating thousands of simulations that would otherwise have to be performed manually.

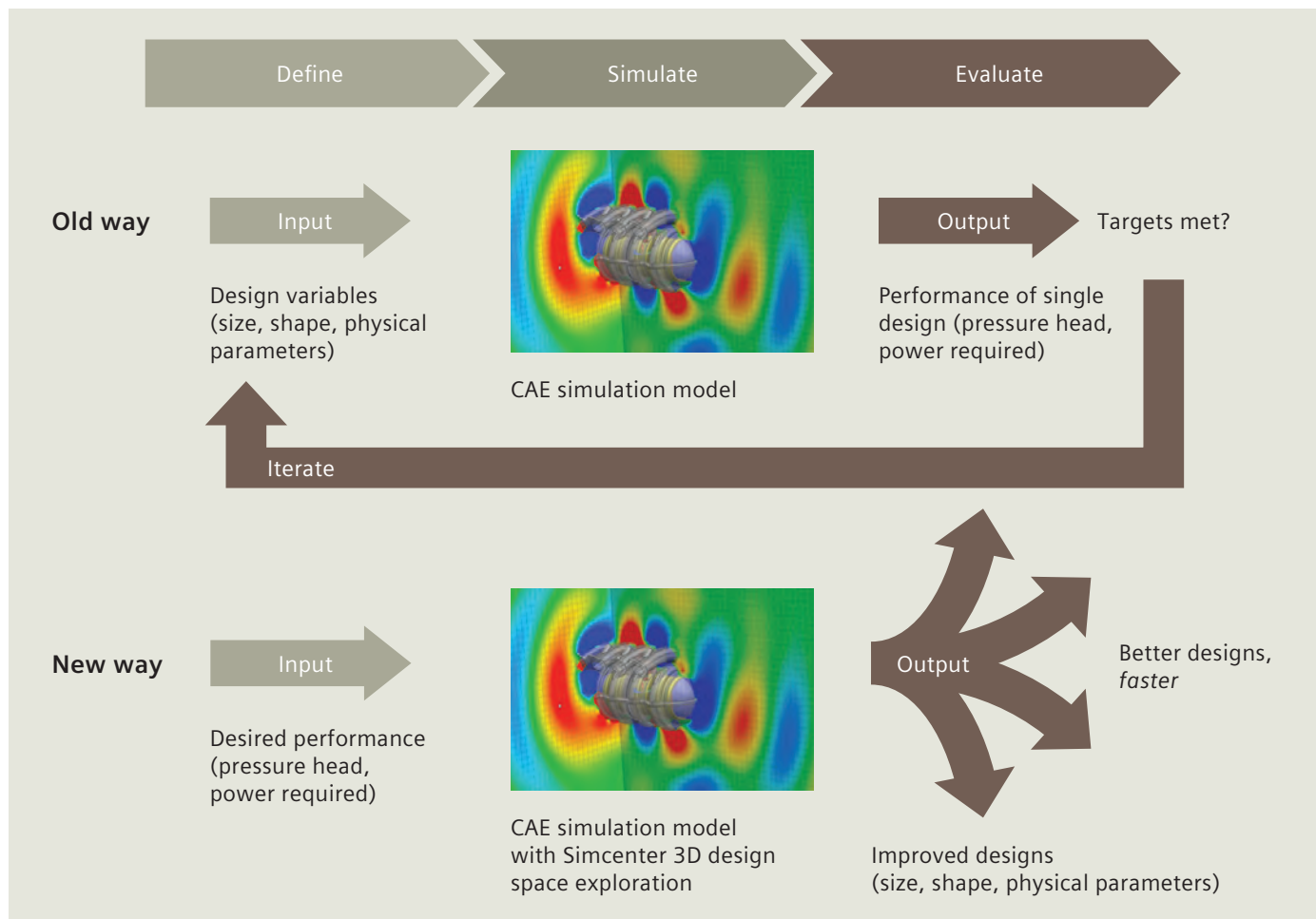

Industry applications

The Simcenter 3D optimization solution can help designers in virtually any industry to achieve a better understanding of the complex relationships among design parameters and how changes affect these relationships. It can also help them realize a better design.

Aerospace and defense

- Airplane frame weight reduction and balancing attributes such as stiffness, modal frequencies, buckling loads
- Airplane wing weight reduction and balancing attributes such as stiffness, modal frequencies, buckling loads
- Airplane weight reduction and balancing attributes for composite airplanes (laminate/ply thicknesses)
- Satellite optimization for thermal stress and distortion, composites, modal frequency
- Launch structure weight reduction
- Aero engine fan shape optimization (compensation for centrifuge and other mechanical effects)
- Aero engine compressor weight reduction and performance balancing
- Aero engine turbine weight reduction and performance balancing
- Aero engine casing weight reduction

Automotive and transportation

- Body roof crush, panel strength, stiffness, frame durability
- Powertrain/driveline performance optimization, torque loads, thermal stress and distortion
- Chassis harshness loads, suspension deflections
- Suspension performance optimization and weight reduction
- Off-highway vehicles balancing weight reduction with strength, durability, rollover protection structure (ROPS), stability
- Manufacturing tool thermal stress and distortion, modal frequency, bolted stresses
- Support structure stability, stress

Marine

- Full ship stiffness, deformation, strength optimization, weight reduction

Consumer goods

- Packaging shape optimization

Simcenter Nastran Optimization

Simcenter Nastran® Optimization software enables customers to establish design sensitivity based on simulated performance conditions and then synthesize and optimize designs. Efficient algorithms permit the use of hundreds of design variables and responses for the largest models. A broad range of robust optimization algorithms and approximation methods provide the backbone of a solution that allows numerous design variables and constraints to be more easily linked and rationalized to identify critical issues.

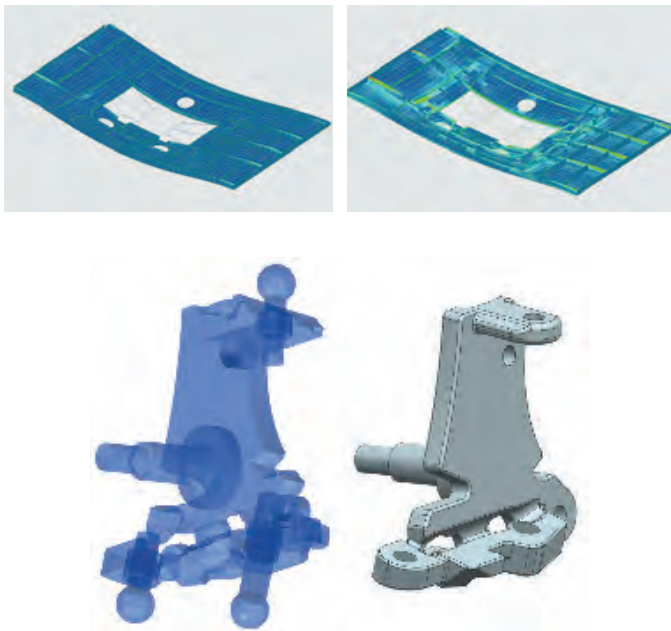

Module benefits

- Reduce design risk by better understanding the complex relationships among design parameters and how changes affect these relationships
- Improve confidence that your product will perform to specifications under a variety of operating conditions and manufacturing tolerances
- Accelerate innovation by determining feasible new designs that satisfy all requirements
- Shorten time-to-market by automating thousands of simulations that would otherwise have to be performed manually

Key features

- Optimization of Simcenter Nastran models
- Constraints related to static, normal modes and buckling analysis
- Optimization capabilities associated with Simcenter Nastran Enterprise Advanced analysis types, such as superelements, dynamic response, modal frequency response, direct frequency response, modal transient response, acoustic analysis, static aeroelasticity and flutter
- Large scale optimization problems thanks to robust optimization algorithms and sparse matrix solutions
- There are hundreds of responses available for the objective and constraints
- Synthetic variables and responses can be created and combined with other responses in equations to responses for the objective and constraints

Simcenter Nastran Topology Optimization

Simcenter Nastran Topology Optimization software offers the capability to optimize many different criteria in support of generative engineering. The solution enables the user to optimize the topology of regions defined as solids or shells and offers the capability to predict solid and lattice zones.

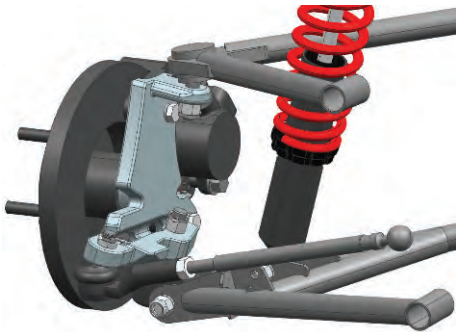
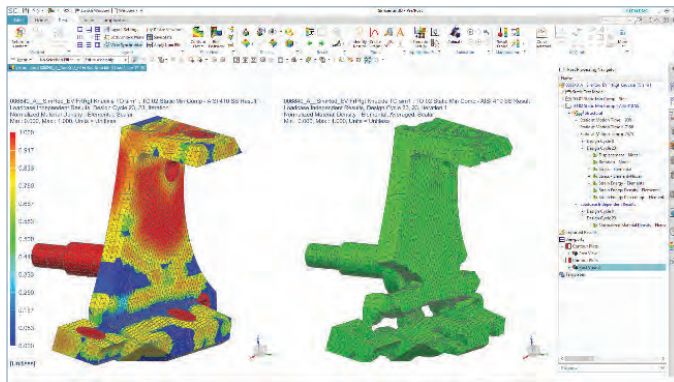

Module benefits

- Shorten time-to-market by directly starting from optimal topology for a large set of optimization objectives and constraints related to statics, modal, buckling, direct and modal frequency analysis. Common examples include objectives to maximize stiffness, minimize mass, maximize mode, subject to mass, displacement, stress constraints
- Hosted in Simcenter 3D, enabling complete workflow from concept to final design
- Functional requirements are represented by shape control constraints, for example to support manufacturing, symmetry and size requirements
- Solid and lattice zone prediction

Key features

- Many methods are available to build the finite element (FE) model: orphan mesh, single computer-aided design (CAD) part and single finite element method (FEM), CAD assembly and single FEM or AFEM
- The design areas can be constructed using 2D shell or 3D solid elements and there can be multiple design areas with different materials representing different parts in an assembly, or homogenized meta-materials (lattices, varying density printed materials, etc.)
- Within a single topology optimization, the user can have any mix of analysis subcases selected from linear statics, normal modes, buckling analysis, direct and modal frequency
- There are hundreds of responses available for the objective and constraints
- Synthetic variables and responses can be created and combined with other responses in equations as responses for the objective and constraints

Simcenter 3D Design Space Exploration

Simcenter 3D Design Space Exploration brings the power of parametric design space exploration to the desk of the user with low cost of adoption. It helps companies to move beyond standard use of simulation for validation, troubleshooting and basic prediction by automatically exploring broader design spaces to more rapidly discover much better designs.

The user can leverage smooth process automation, which simplifies the virtual prototype build process to exploit the distributed execution that accelerates virtual prototype testing. This enables the user to access efficient design search capabilities without the need for simplifying models. Additionally, the user has access to a complete insight and discovery interface that is a central part of virtual product development rather than an afterthought.

Module benefits

- Efficiently find good designs with many variables
- Selecting algorithms is automated and automatically tunes it throughout the design study
- The solution leverages all search strategies simultaneously
- Eliminates iteration and finds the best way to traverse the design space every time
- With an advanced algorithm and easy-to-use interface, the solution precludes the need for optimization expertise

Key features

- Design space exploration and optimization for Simcenter 3D models
- Extensive support for Simcenter 3D model parameterization (including geometry, materials, finite element characteristics, solution parameters, etc.)
- Automates workflows, which streamlines data transfer across tools, eliminates errors in the process and significantly increases the efficiency
- Plethora of design-of-experiment (DoE) algorithms
- Cutting edge SHERPA optimization strategy, the advanced auto-tuning optimization strategy for single and multi-objective optimization
- Support for mixed continuous/discrete variable problems with multiple constraints
- A powerful but easy-to-use data analytics solution for gaining valuable insights into designs and design space
- Support for surrogate model creation and export

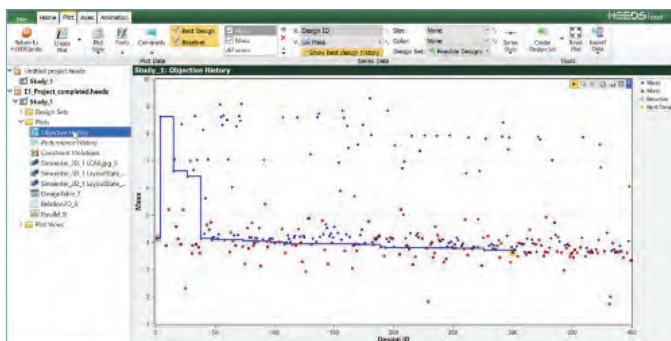
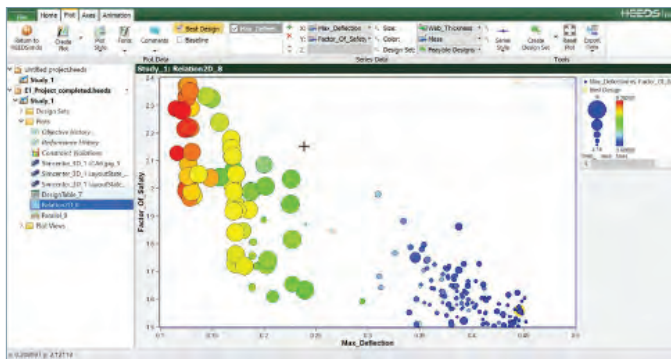

Simcenter 3D Geometry Optimization

Simcenter 3D contains geometric and sizing optimization capabilities, all part of the standard Simcenter 3D Engineering Desktop. Simcenter 3D Geometry Optimization is a meta-solution process built on an existing solution. It provides classical capabilities for the selection of design variables and objective and constraint functions together with several optimization solution controls and postprocessing capabilities.

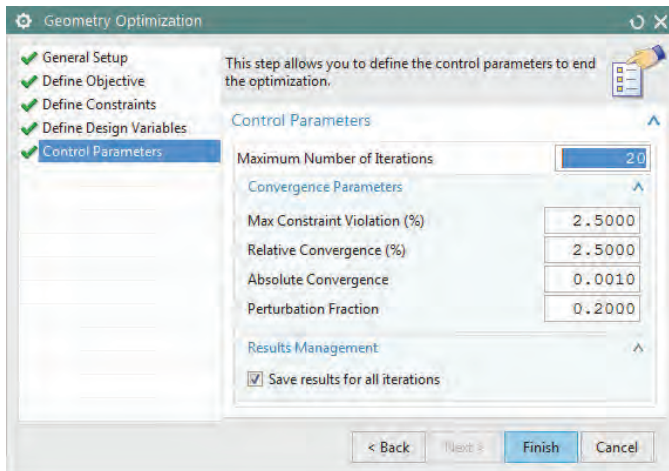
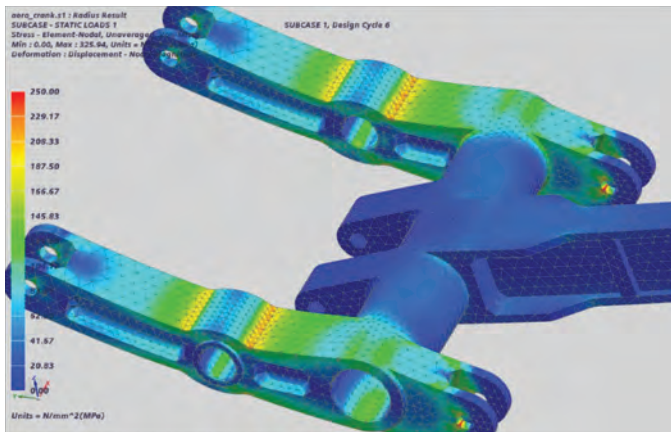

Module benefits

- Easily optimize geometry of element properties of Simcenter 3D models and the associated CAD models
- Reduce design risk by better understanding the complex relationships among design parameters and how changes affect those relationships
- Improve confidence that your product will perform to specifications under a variety of operating conditions and manufacturing tolerances

Key features

- Optimization of Simcenter 3D models and the associated CAD models
- Mixed CAD and FE geometry optimization: FE beam section properties, FE shell thickness, CAD model feature dimensions, CAD model sketch dimensions, expressions, including expressions that define an FE load
- Supported solvers: Simcenter Nastran, Simcenter 3D Thermal, Simcenter 3D Flow, Simcenter ESC, Simcenter SST, MSC Nastran, ANSYS, ABAQUS
- Types of responses for objective and constraints will vary depending on the solver. Examples include: weight, volume, temperature, mass flow, Joule data, radiation view factors, etc.
- FE result measures can also be used as responses; for example, max displacement, average Von Mises Stress. These can be measured globally or locally based on geometry distribution; for instance, on a face or along an edge
- Optimization solution data can be displayed in a spreadsheet

Capabilities chart

General capabilities	Specific capabilities	Simcenter Nastran Optimization	Simcenter Nastran Topology Optimization	Simcenter 3D Design Space Exploration
Integration with Simcenter 3D		•	•	•
Model parameterization	With associated CAD models	•	•	•
	Without associated CAD models	•	•	•
	Full Simcenter Nastran elements types suitable for analysis types	•	•	•
	Full Simcenter Nastran load and constraint types suitable for analysis types	•	•	•
	Other solver environments			•
Design volume	2D, 3D elements		•	
	Multiple design volumes		•	
	Different materials to present different parts and meta-materials (lattices, varying density printed materials, etc.)		•	
Variables	Every FE element in the design volume(s)		•	
	Element physical properties	•		•
	Composite element properties	•		•
	Connecting element properties	•		•
	Material properties	•		•
	CAD model expressions include feature and sketch dimensions, load inputs			•
Materials	Derived variables and formulas based on model responses			•
	Isotropic, anisotropic, orthotropic	•	•	•
Analysis types	Linear statics	•	•	•
	Structural dynamics	•	•	•
	Buckling	•	•	•
	Acoustics			•
	Thermal			•
	Flow			•
	Coupled thermal/flow			•
Optimization objective	Single objective	•	•	•
	Single global or subcase objective	•	•	•
	Multi-objective			•
Optimization constraints	Multiple	•	•	•
	Multiple global or subcase objectives	•	•	•
	Relationships between variables			•
	Shape control constraints		•	
Optimization algorithms	Gradient	•	•	•
	Penalty laws linear, solid isotropic material with penalization (SIMP), rational approximation of material properties (RAMP)		•	
	Lattice prediction based on lattice type characterization		•	
	Optimization controls and convergence parameters	•	•	•
	Design space exploration (DoEs, design sets)			•
	Auto-tuning optimization strategy - SHERPA			•
Multi-objective auto tuning optimization strategy - multiobjective SHERPA			•	

General capabilities	Specific capabilities	Simcenter Nastran Optimization	Simcenter Nastran Topology Optimization	Simcenter 3D Design Space Exploration
Simulation automation	Sequential simulation execution	•	•	•
	Parallel simulation execution			•
	Support for remote execution			•
Postprocessing	Optimization spreadsheet to summarize objective and constraint values per iteration	•	•	•
	Simcenter 3D postprocessing functionality	•	•	•
	Dedicated normalized material density display		•	
	Auto creation of post optimization verification model		•	
	Advanced postprocessing (parallel plots, bubble plots, 3D functions, etc.)			•
	Response surface modeling			•
	Correlation plots			•
	Pareto plots			•
	Principal component analysis and influence analysis			•
	Analysis monitoring and control			•
Design geometry recovery	Update of CAD models			•
	Update of FE model	•		•
	Export of smoothed mesh back to CAD for design guidance in remodeling		•	

Legend:

- = included in module
- + = additional product required

Note: Simcenter 3D Engineering Desktop is a minimum prerequisite for all Simcenter 3D products. Other dependencies or prerequisites may apply for individual products.

SIEMENS

Ingenuity for life

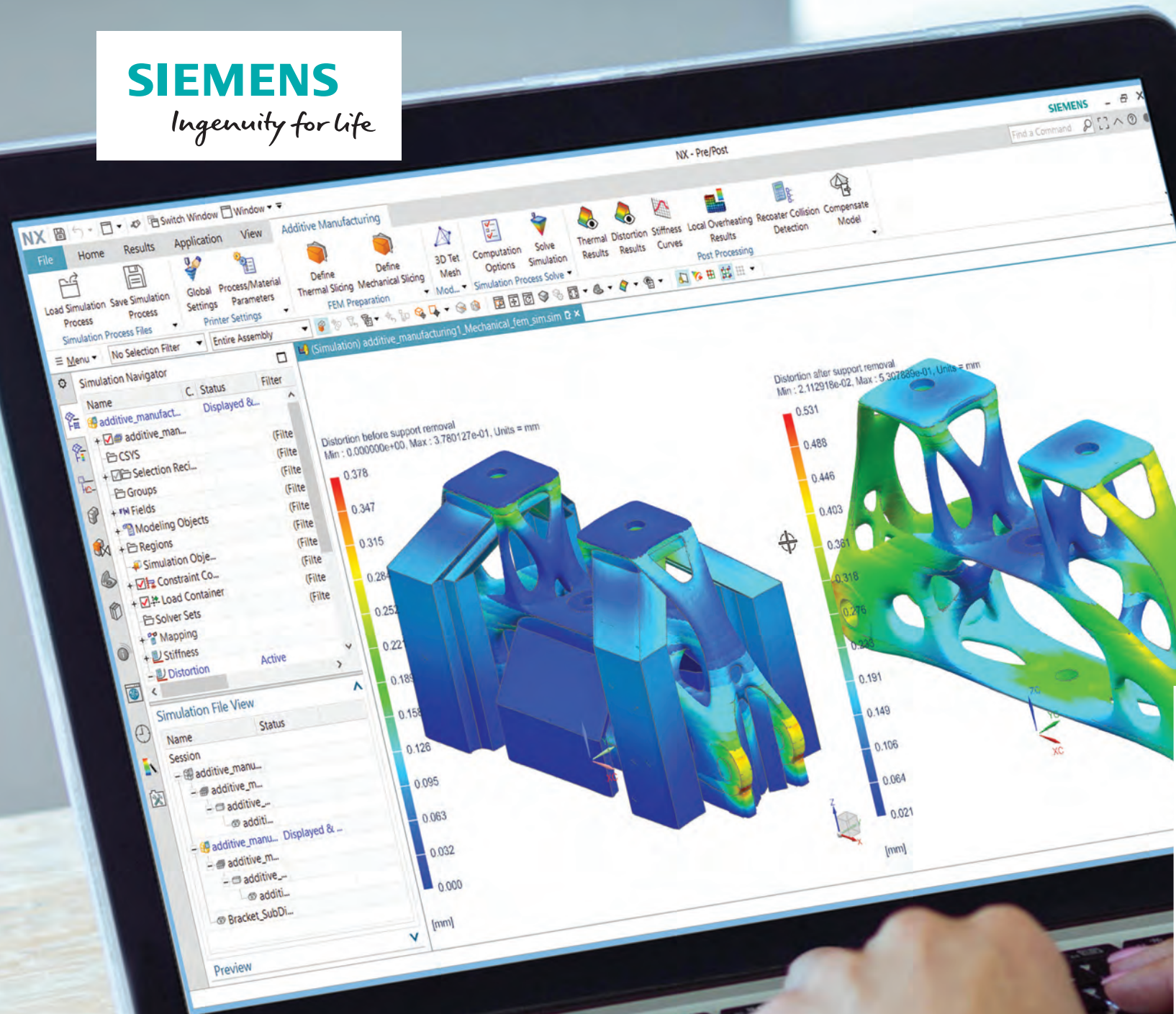

Siemens Digital Industries Software

Simcenter 3D for additive
manufacturing simulation

Print right the first time

[siemens.com/simcenter3d](https://www.siemens.com/simcenter3d)



Solution benefits

- Print right the first time
- Simulate the build process for metal powder bed fusion additive manufacturing applications
- Predict potential geometry distortions during the build
- Investigate efficiently different build positions and support scenarios
- Mesh the specimen geometry exactly using powerful Simcenter 3D algorithms
- Generate compensated geometry (BREP) based on the simulated distortion fields

Additive manufacturing (AM) is changing the way products are made. New revolutionary machines and processes are rapidly pushing AM from the prototype environment onto the production floor. The additive manufacturing capabilities in Simcenter™ 3D software are used to predict distortions and defects before parts are printed, thereby reducing the number of test prints and improving the quality of the final print.

High-quality simulation environment

The high-quality simulation capabilities of Simcenter 3D are paramount to industrializing AM. During the AM process simulation, the parts are meshed accurately with tetrahedron meshes and sliced afterward, which gives better results than voxel meshes.

Enhanced inherent strain approach

A new approach was developed that was brought to the market with Simcenter 3D. The layer-by-layer build process during the powder bed fusion printing leads to layer shrinkage during the cool down of the layer. The stiffness of the printed structure has a strong influence on part distortion.

Simcenter 3D for additive manufacturing simulation

Print right the first time

Calculated distortions can be used to compensate for the part prior to the printing process. The initial geometry can be automatically morphed into the precompensated shape and replaced in the built tray for further analysis, or it can be sent directly to the printer to be printed correctly the first time.

Fully integrated with NX end-to-end workflow

Simcenter 3D for AM is seamlessly integrated into the end-to-end Siemens' digital enterprise software AM workflow. The process is streamlined to be used by nonexpert computer-aided engineering (CAE) users as well.

Providing a platform for multidiscipline simulation

The Simcenter 3D AM solution is part of a larger, integrated multidiscipline simulation environment with Simcenter 3D Engineering Desktop at the core for centralized pre-/postprocessing for all Simcenter 3D solutions. This integrated environment helps you to achieve faster CAE processes and streamline

multidisciplinary simulations that integrate additive manufacturing with any of the Simcenter 3D solutions, such as thermal mechanical, vibro-acoustic, or other more complex analyses.

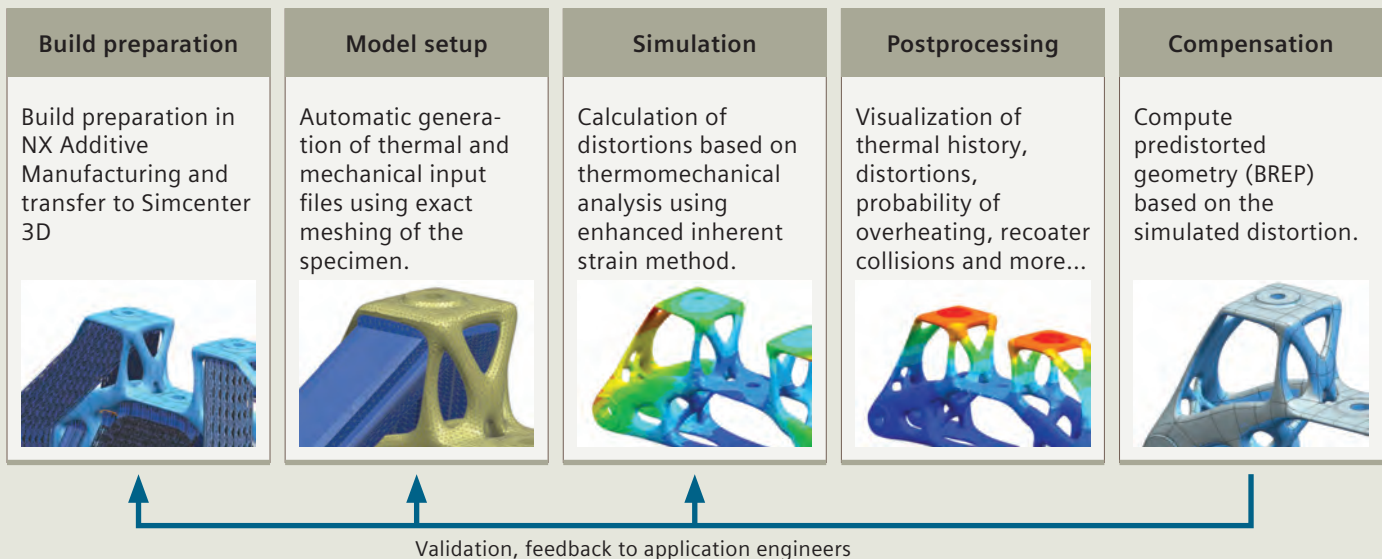

Industry applications

Today, AM is still mainly a research and development (R&D) activity as this process remains expensive and slow, preventing its use for large projects such as in the automotive industry. However, some industrial applications are already linked to the printing of complex parts, which are difficult to produce by traditional methods. The primary goal is to create parts that are lightweight and have good mechanical properties. Repairing parts previously produced by traditional processes can also be a valuable application of AM due to the unique nature of each component.

Aerospace and defense

The space industry already produces structural parts for launchers. The goal is to produce parts that are light-weight and have good mechanical properties.

The airplane industry is also developing this technology, but is in more of an exploratory phase with the goal of producing components with complex geometry.

Industrial machinery

Power generation appears to be an industry that is exploring AM to produce turbine blades and other combustion chamber components. AM can also be applied to repairing existing turbines.

Automotive industry

Lightweight structures for racing cars and completely new bionic designs can be manufactured with additive manufacturing technology. Generative design can be used to find new proposals that can be manufactured with additive manufacturing technology.

NX AM integrated solution

Simcenter 3D

Simulate printing process
 Predict thermal distortion
 Allow compensation and print right first time

Simcenter 3D Additive Manufacturing

Simcenter 3D Additive Manufacturing simulates the AM process for selective laser melting (SLM). The setup from a part in the built tray, including support structures, is used as a basis. The user selects the parts to simulate and define printing process parameters (material, number of parts, layer slicing, laser parameters, etc.) and run the simulation. The result is the temperature distribution and distortion of the part.

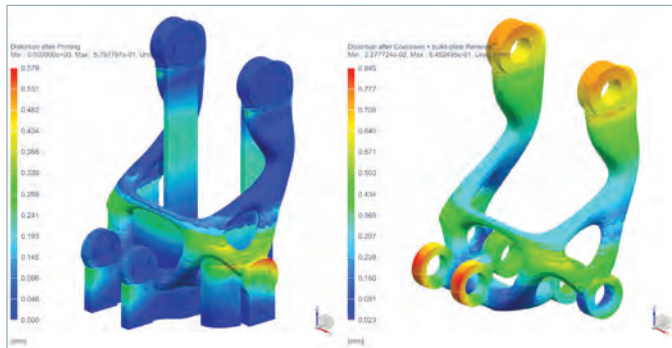

Module benefits

- Simulation of the build process for powder bed fusion metal prints
- Fully integrated into the NX™ software additive manufacturing framework
- Unique model setup and solving methodology

Key features

- Solving the coupled thermomechanical solution
- Material and process parameters for AM
- Consideration of support structures from fixed plane modules
- Analyze thermal distribution
- Analyze distortion before and after support removal
- Detect recoater collision
- Predict probability of overheating
- Efficiently compute stiffness curves
- Compute pre-distorted geometry for compensation

Omnimesh for Simcenter 3D

Simcenter 3D Additive Manufacturing is used to compute the distortion of parts during the AM process. The part distortions can be transferred to the initial geometry to pre-deform it using powerful geometry modification techniques based on the boundary representation (BREP) model. A new compensated part file is generated that can be used to replace the original part on the build tray. The compensated geometry is then used for validation and can be directly sent to the printer.

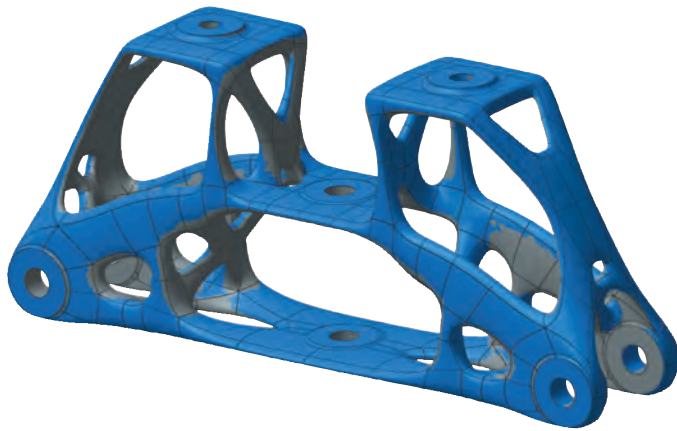

Module benefits

- Pre-deformation of BREP geometry
- Generation of NX part files of compensated geometry

Key features

- Compute pre-distorted geometry for compensation
- Read distortion field from Simcenter 3D Additive Manufacturing
- Fully integrated into the additive manufacturing workflow



Capabilities chart

General capabilities	Specific capabilities	Simcenter 3D Additive Manufacturing	OmniMesh for Simcenter 3D
Simulation capability			
Distortion analysis	Layer-by-layer simulation	•	
Thermal history	Simulate the thermal history of single or multiple parts on the build tray	•	
Support failure	Prediction of support failure	•	
Recoater collision	Identify layers with large deformation in z-direction	•	
Probability of overheating	Identify areas with high overheating probability	•	
Prediction of shrinklines	Stiffness analysis of the part to identify shrinklines	•	
Thermomechanical analysis	Coupled thermomechanical analysis	•	
Heat treatment	Stress relief load case for nickel-based alloys	•	
Cool down	Cool down to ambient temperature	•	
Support removal	One step support removal and cutoff from the build tray	•	
Material			
Metal	Application for metal powder bed fusion	•	
Model setup			
Powder mesh	Meshing the powder for thermal analysis	•	
Detailed meshing (tetrahedrons)	Detailed meshing of the specimen	•	
Mesh slicing	Layer setup is realized by mesh slicing	•	
Manual change of meshing setup	Flexibility to manually modify the mesh and simulation setup	•	
Homogenized material for support structures	Use solid meshes for supports and apply homogenized material (properties can be determined in the application)	•	
Compensation			
Compensate geometry based on BREP body	Compensation of part in additive manufacturing build tray		•

Note: One fixed plane product is a minimum prerequisite for Simcenter 3D AM. The Simcenter 3D AM Product is a prerequisite for Omnimesh for Simcenter 3D. Other dependencies or prerequisites may apply for individual products.

SIEMENS

Ingenuity for life



Siemens Digital Industries Software

Simcenter 3D for aerostructures

Streamlining the structural sizing and assessment
process from end-to-end

[siemens.com/simcenter3d](https://www.siemens.com/simcenter3d)



Solution benefits

- Perform end-to-end aerostructure assessment in a fully integrated environment
- Eliminate mistakes and ramp up productivity with ready-to-use failure prediction methods from reference handbooks
- Customize the solution by integrating your knowhow and tools intuitively and taking advantage of your aerostructure experience
- Reduce effort needed for reporting and streamlining stress report generation
- Facilitate dedicated criticality-focused postprocessing

The Simcenter™ 3D software for aerostructures solution is composed of the Simcenter 3D Aerostructure Environment and Simcenter 3D Margin of Safety modules. The modules run on Simcenter 3D Engineering Desktop and Simcenter 3D Structures and enable you to streamline the structural sizing and assessment process from end-to-end.

The powerful geometry editing and meshing capabilities of Simcenter 3D Engineering Desktop are ideal for pre- and postprocessing models. Using Siemens Digital Industries Software's Simcenter 3D, which is part of the Simcenter portfolio, simplifies the modeling process by integrating high-end finite element method (FEM) tools with geometry capabilities that assist the user in developing analysis models faster than with traditional computer-aided engineering (CAE) preprocessors. Simcenter 3D Margin of Safety enables structural assessment with standard analytical methods and/or company methods.

Simcenter 3D for aerostructures

Efficiently analyze margin of safety

In addition to the detailed finite element models approach, engineers can size aerostructure components using a library of analytical engineering methods. With the capability to generate stress reports using data and simulation results, engineers benefit from a consistent and integrated global process, resulting in time savings over the full design cycle.

With an increasing amount of data and results to be handled and shared between teams, models, simulation results and tools can be managed and traced in Teamcenter® software.

Integrated solution to predict margin of safety

- Dedicated preprocessing enables you to prepare margin-of-safety calculations for numerous load cases simultaneously, which is available in Simcenter 3D, a powerful finite element pre-/postprocessing open environment. All load cases can be tagged with labels such as "limit" or "ultimate" to facilitate the partitioning of assessed failure criteria
- Dedicated postprocessing focuses on the criticality of results, either from a global, failure mode or load case point of view
- Results can be browsed to assess structural integrity thanks to sortable and filterable tables
- Each method provides a log for detailed explanations of assumptions

- Dedicated 3D display of margin values combined with the typical finite element (FE) postprocessing display enables you to graphically locate the areas that need design updates

Increase productivity with standard methods

Simcenter 3D Margin of Safety software comes with standard engineering formulas from aerostructure reference handbooks, such as E.F. Bruhn's, "Analysis and Design of Flight Vehicle Structures," M.C.Y. Niu's, "Airframe Stress Analysis and Sizing," National Advisory Committee for Aeronautics (NACA) technical notes, NASA technical memorandums, etc. Each method comes with detailed engineering documentation.

Flexibility to embed user-defined methods

Simcenter 3D Margin of Safety allows you to integrate in-house libraries of methods. The availability of analysis building blocks (for example, ready-to-use engineering formulas, such as buckling and plasticity curves and out-of-the-box standard methods) enables users to save a large amount of time on integrating methods.

Customized reporting

A detailed stress report can be generated in Microsoft Word format from the Simcenter 3D Margin of Safety result and the associated finite element analysis (FEA).

The template is composed of key words, and thus can be tailored to fit company best practices. The template can include user textual feedback, snapshots, summary tables, etc.

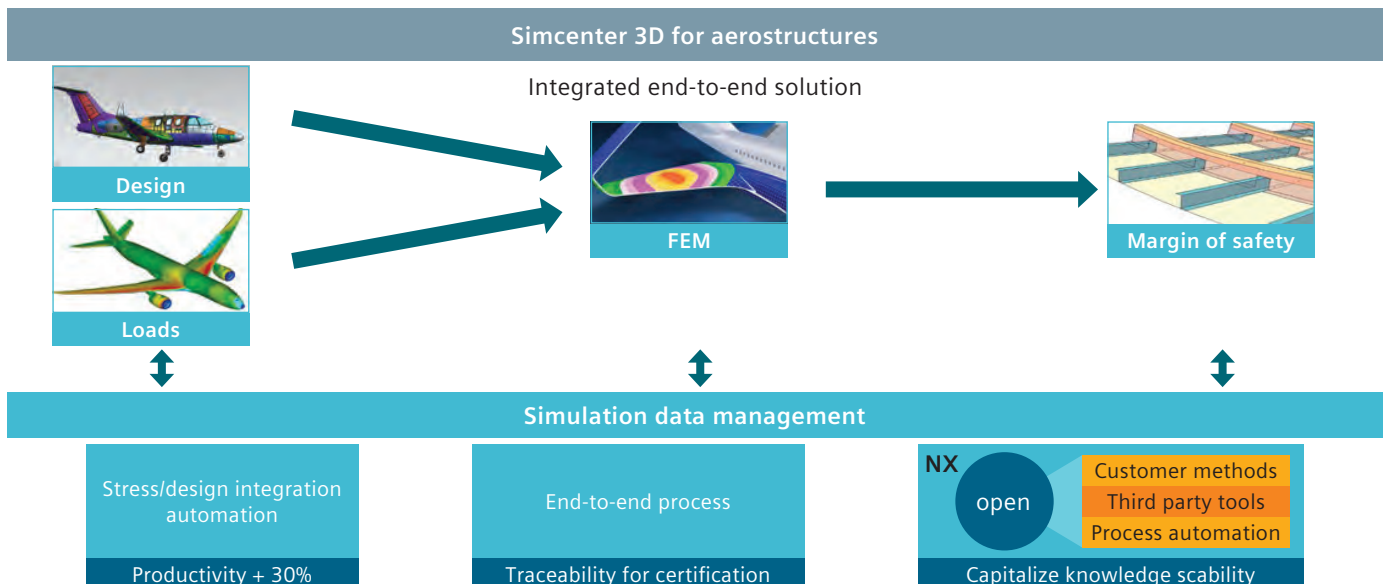

Industry applications

Simcenter 3D Aerostructure facilitates full traceability for certification of an end-to-end integrated solution for sizing. It streamlines the structural process from computer-aided design (CAD), FE simulation and margin-of-safety calculations to reporting. Simcenter 3D Aerostructure offers a scalable solution for embedding in-house margin-of-safety methods as libraries.

Therefore, it makes it possible to manage design changes efficiently with CAD/CAE associativity.

Aerospace and defense

Specific vertical application dedicated to the sizing of frames, wings and the global view of airplanes.



Simcenter 3D Aerostructure Environment

Simcenter 3D Aerostructure Environment provides a set of tools dedicated to simulation. It is a prerequisite for Simcenter 3D Margin of Safety.

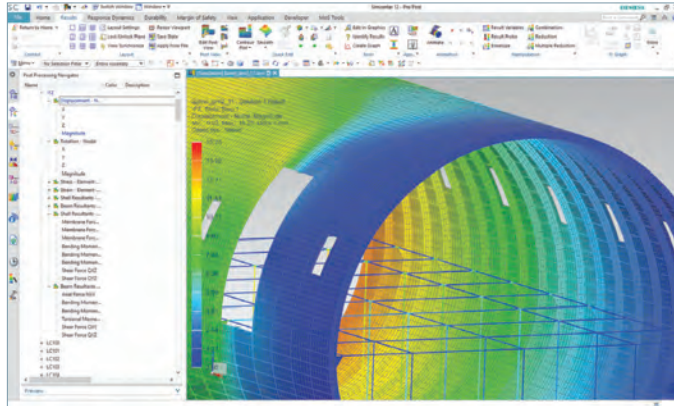

Module benefits

- Manage meaningful sets of load cases to help structurally assess criticalities
- Provide a harmonized environment for structural assessment, thus decreasing the learning curve as well as democratizing assessment throughout the engineering community

Key features

- Load case tagging and partitioning: All load cases can be tagged with labels such as "limit" or "ultimate" to facilitate the partitioning of assessed failure criteria

Simcenter 3D Margin of Safety

Simcenter 3D Margin of Safety brings a streamlined, traceable and enterprise-wide approach to aerostructure sizing so you can calculate everything from static loads to margins of safety.

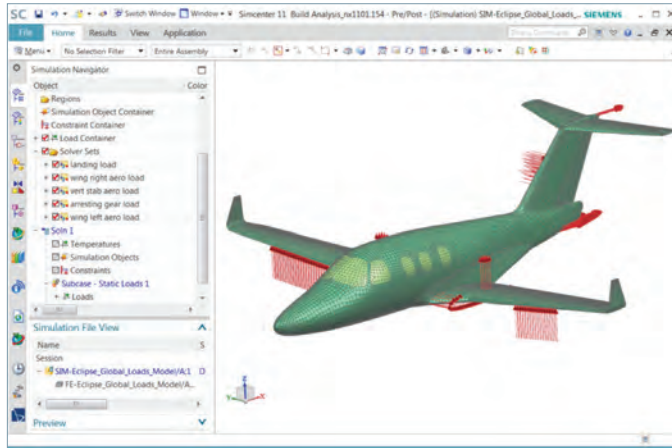
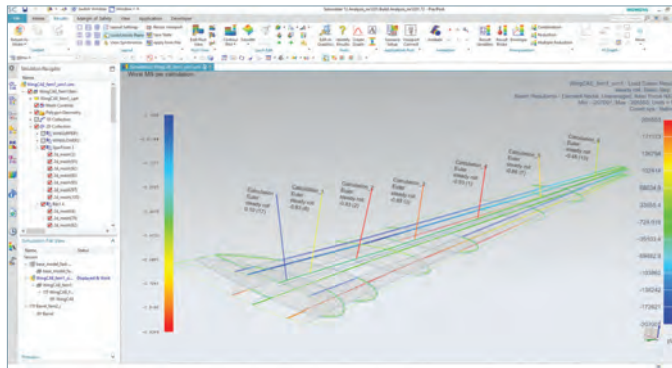

Module benefits

- Traceability for certifying an end-to-end integrated solution for aerostructure sizing
- Streamline the structure process from CAD, FE simulation and margin-of-safety calculations to reporting
- Scalable solution for embedding in-house margin-of-safety methods and libraries
- Manage design changes efficiently with CAD/CAE associativity

Key features

- Dedicated preprocessing enables you to prepare margin-of-safety calculations for numerous load cases simultaneously, which is available in Simcenter 3D, a powerful finite element pre-/postprocessing open environment
- Dedicated postprocessing focuses on criticality of results, either from a global, failure mode or load case point of view
- Results can be browsed to assess structural integrity thanks to sortable and filterable tables
- Each method provides a log for detailed explanations of assumptions
- Dedicated 3D display of margin values combined with the typical FE postprocessing display enables you to graphically locate the areas that need design updates

Capabilities chart

General capabilities	Specific capabilities	Simcenter 3D Aerostructure Environment	Simcenter 3D Margin of Safety
Margin of safety calculation			
Link to CAD/FE	CAD/FE/stress associativity for geometry update or load update	+	•
	Retrieve data from CAD (geometry)	+	•
	Retrieve data from FEM (geometry, internal load)	+	•
	Geometry and load idealization		•
Margin of safety calculation	Analytical methods from reference-standard methods or end-user methods		•
	Simcenter metallic methods		•
	Simcenter composite methods		•
Margin of safety post-processing	Dedicated postprocessing for margin of safety		•
	Stress report automated generation	+	•
Margin of safety preprocessing			
Geometry			
Source for geometry	Geometry data from CAD		•
	Geometry data from FE model		•
	Geometry data from the user input		•
	Massive geometry data populating through journaling		•
Geometry idealization	Predefined idealization		•
	Configurable idealization		•
Loads			
Load source	Load extraction from static linear FEM analysis (Simcenter Nastran® software SOL101)		•
	Load extraction from static linear FEM analysis (MSC Nastran SOL101)		•
	Load extraction via freebody		•
	Load data from the user input		•
	Load data from external load files		•
Loads preparation	Group load case (load case set)	+	•
	Combined load cases	+	•
	Loads case (LC) envelop (filtering/selection of LC by result values)	+	•
	Strength requirement of load case (example: ultimate/limit)	+	•
Load idealization	Predefined load idealization		•
	Configurable load idealization		•

General capabilities	Specific capabilities	Simcenter 3D Aerostructure Environment	Simcenter 3D Margin of Safety
Material			
Metallic material	Metallic static (isotropic, orthotropic, anisotropic)		•
Composite material	Composite (unidirectional long fiber)		•
Margin of safety analysis			
Type of calculation	Analytical calculation		•
	FEM calculation		•
Stress discipline	Metallic static		•
	Composite static		•
Solve	Manage calculation of margin of safety		•
	Batch		•
Simcenter metallic methods (fully integrated)			
Strength failure mode	Tension/compression/shear		•
	Tresca (plane stress)		•
Buckling from Bruhn manual	Plate (flate/curved) buckling analysis under different loads (compressive/shear/bending/mixed interaction)		•
	Column buckling analysis (Euler/Euler-Johnson, Euler-Engesser)		•
	Torsional buckling		•
	Profile crippling analysis		
Bolt/fastener from Bruhn and Nasa	Inter-rivet buckling		•
	Shear, bending, tension, interaction of a bolt		•
	Bolt/load redistribution		•
Material properties calculation	Plasticity (plastic reduction factor charts, stress from strain in plastic domain)		•
	Material law (shear yield stress allowable estimation Fsy, secant/tangent modulus, stress F0,7)		•
Simcenter composite methods (fully integrated)			
Buckling	Plate buckling analysis under different loads (compressive/shear/mixed interaction)		•

General capabilities	Specific capabilities	Simcenter 3D Aerostructure Environment	Simcenter 3D Margin of Safety
Dedicated postprocessing for margin of safety			
	3D postprocessing of critical margin of safety, load case, failure mode		•
	Table of critical margin of safety, load case, failure mode		•
	Detail log of the analysis run		•
Stress report automated generation			
	Structured templated document	•	•
	Critical margin of safety table		•
	3D snapshots (CAD, FE results, etc.)	•	•
	Material summary	•	•
Openess			
Methods integration	Integration of customer methods: legacy analysis codes or launch of executable		•
	On-the-fly mathematical formulation definition		•
	Automation of high-level process (for example, automate series of clicks) through journaling	•	•
	Add user defined material	•	•
	Add user defined material properties (for example, allowables)	•	•
	Add user defined profile cross-section	•	•
	Integration of specific postprocessing of margin of safety (including results files in external viewer)		

General capabilities	Specific capabilities	Simcenter 3D Aerostructure Environment	Simcenter 3D Margin of Safety
Documentation			
	End-user documentation	•	•
	Methods formulation documentation		•
	Method integration documentation		•
Deployment			
Deployment to end users	Redistribute nonnative methods		•

Legend:

- = included in module
- + = additional product required

Note: Simcenter 3D Engineering Desktop is a minimum prerequisite for all Simcenter 3D products. Other dependency or prerequisites may apply for individual products.

SIEMENS

Ingenuity for life

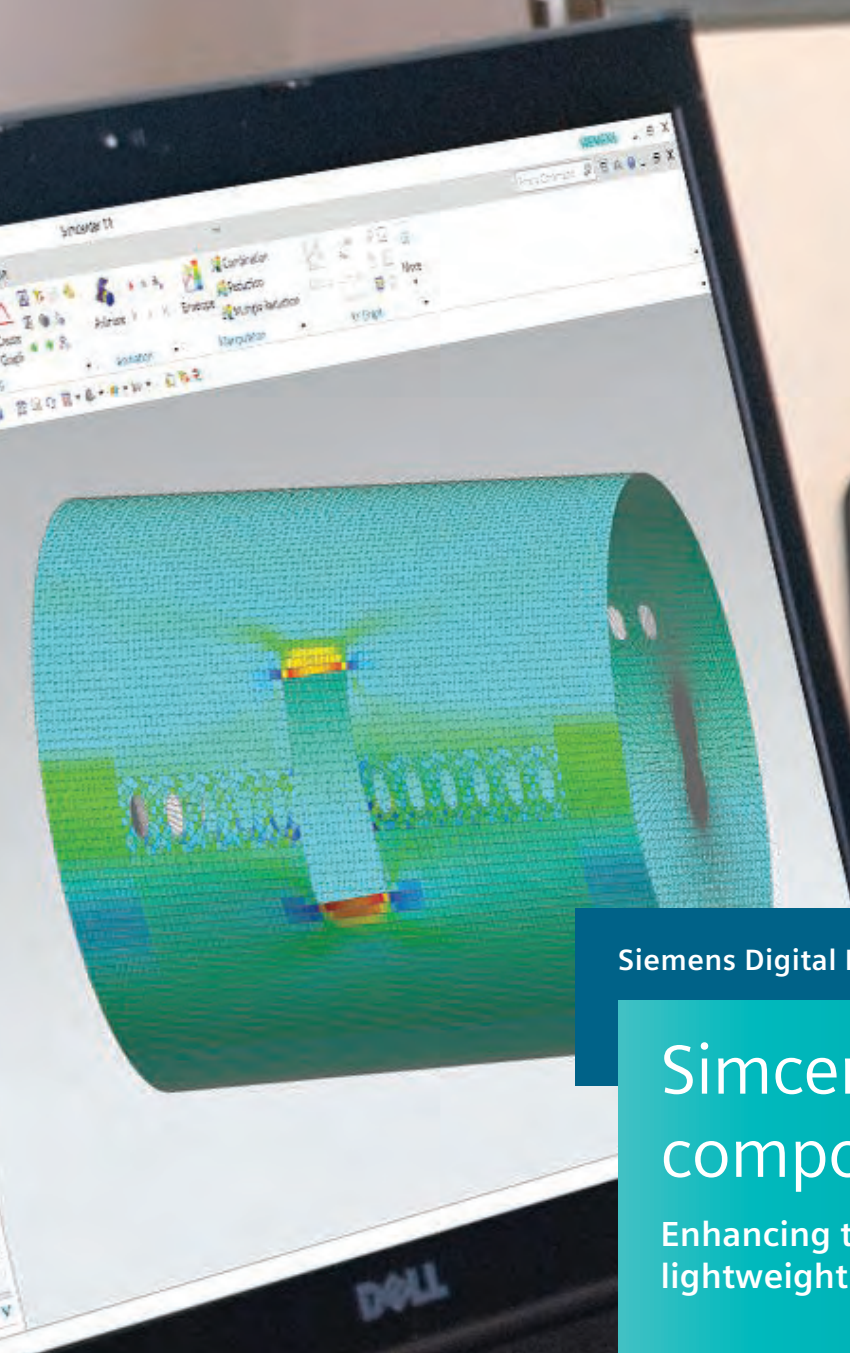

Siemens Digital Industries Software

Simcenter 3D for composites simulation

Enhancing the development of robust,
lightweight structures

[siemens.com/simcenter3d](https://www.siemens.com/simcenter3d)



Solution benefits

- Achieve weight reduction targets while providing safe and durable structures
- Capture and identify the behavior of composite components, reducing overdesign
- Control and reduce development costs of composite structures
- Mitigate risk by controlling processes up front with a collaborative workbench
- Simulate manufacturing process phenomena for designing as manufactured
- Consider manufacturing defects at the early stage of your design process like the springback after a curing cycle

Simcenter™ 3D software from Siemens Digital Industries Software provides a complete set of features and digital workflows that allow you to predict classical first-ply failure, stress, thermal and thermomechanical co-simulation, including manufacturing simulation with curing. This solution can support design with continuous fiber like unidirectional ply, sandwich, woven type of material and with fiber reinforced plastic.

Scalable solution for composites simulation

Simcenter 3D supports native composite material as well as other types of advanced materials like lattice structure or plastic material. It provides an efficient workbench for composites with a large set of tools to extract mid plane or modify the geometry on the fly. Simcenter 3D allows you to manage large assemblies with label management, including defining the dedicated physical properties of composite or fiber reinforced plastic materials.

Simcenter 3D for composites simulation

Powerful modeling tools

Simcenter 3D Laminate Composites software is a modular simulation toolset for laminate composite structures (continuous fiber). Easy-to-use ply and laminate definition tools enable you to quickly create finite element (FE) models in 2D and 3D representing your design, and helps you optimize and validate composite structures using your preferred solver. There is also a complete set of features to validate your draping simulation.

The environment provides capabilities to model highly nonlinear effects like progressive damage with dedicated meshing method for cohesive element generation.

Reduce laminate model creation time

Simcenter 3D Laminate Composites allows you to reduce laminate model creation time by choosing between zone-based modeling, ply-based modeling or a mixture of both approaches. Draping data like fiber orientation and material definition can also be imported from specific composite design tools. For instance, it's possible to use the Fibersim™ portfolio, which is bi-directional, for ply exchange to communicate with composites designers. Plies can be imported directly from a Simcenter 3D .prt file, or via an HDF5 file. You can also exchange zone and laminate definitions via the zone interfaces.

Improve composite modeling accuracy

Simcenter 3D Laminate Composites draping algorithms can be used to predict the fiber orientations and shear of unidirectional and woven plies as they drape around doubly curved or undevelopable surfaces. Simcenter 3D enables you to specify a draping start point and direction, or to pick a seed curve. You can then coarsen or refine the drape mesh size and view the ply flat pattern.

Simcenter 3D for composites extends the boundaries of the classic FEA method so you can study the structural and highly nonlinear behavior of composite materials, but also complex phenomena like curing of thermosets. Composites simulation can also be performed using the multidisciplinary capabilities of Simcenter 3D like motion, thermal and durability.

Efficiently create 3D layup inflation

The Simcenter 3D Laminate Composites 3D inflation tool enables you to automatically create detailed, solid laminate models that were previously too tedious to attempt.

You can extrude normal to a 2D mesh or by filling the volume between 2D dependent meshes. You can taper core or filler plies. A dedicated sandwich panel capability allows the automatic generation of 2D or 3D facesheet plies along with a user-defined number of solid element layers for the core. Cohesive elements can be introduced between selected plies by using Simcenter Samcef® software for assessing delamination.

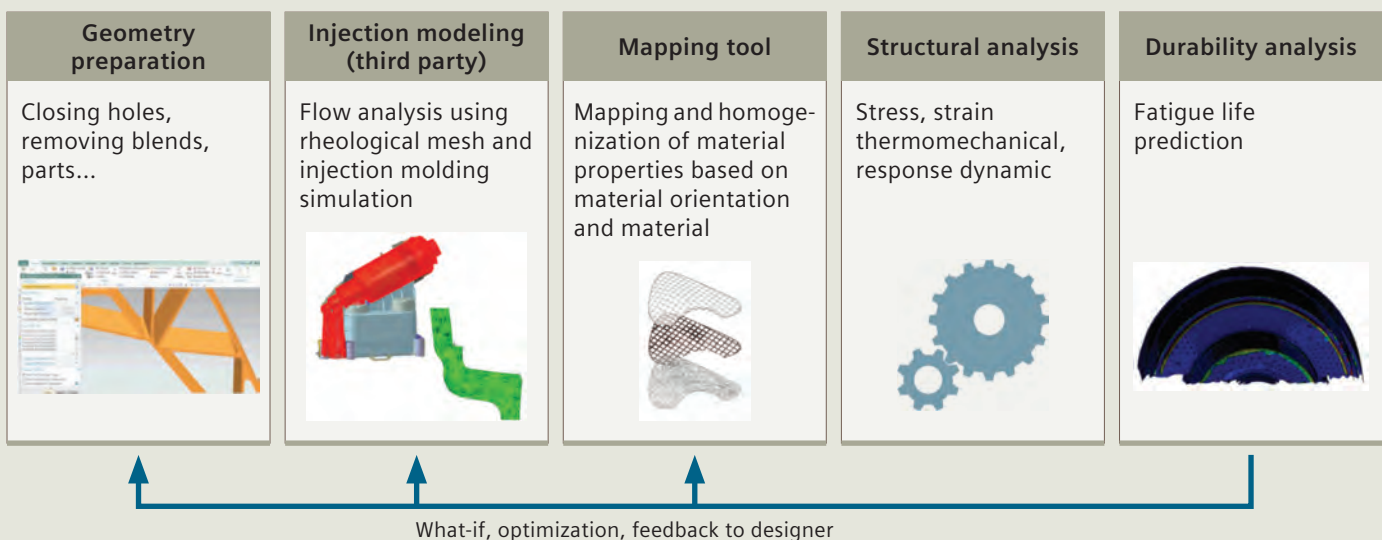

Providing a platform for multidiscipline simulation

The Simcenter 3D composites solution is part of a larger, integrated multidiscipline simulation environment with the Simcenter 3D Engineering Desktop at the core for centralized pre-/postprocessing for all Simcenter 3D solutions. This integrated environment helps you to achieve faster computer-aided engineering (CAE) processes and streamline multidiscipline simulations such as motion analysis and/or the noise, vibration and harshness (NVH) analysis of composites components. You can also validate your composite structure fatigue life using Simcenter 3D durability modules and validate your FE model with test results using correlation and model updating tools.

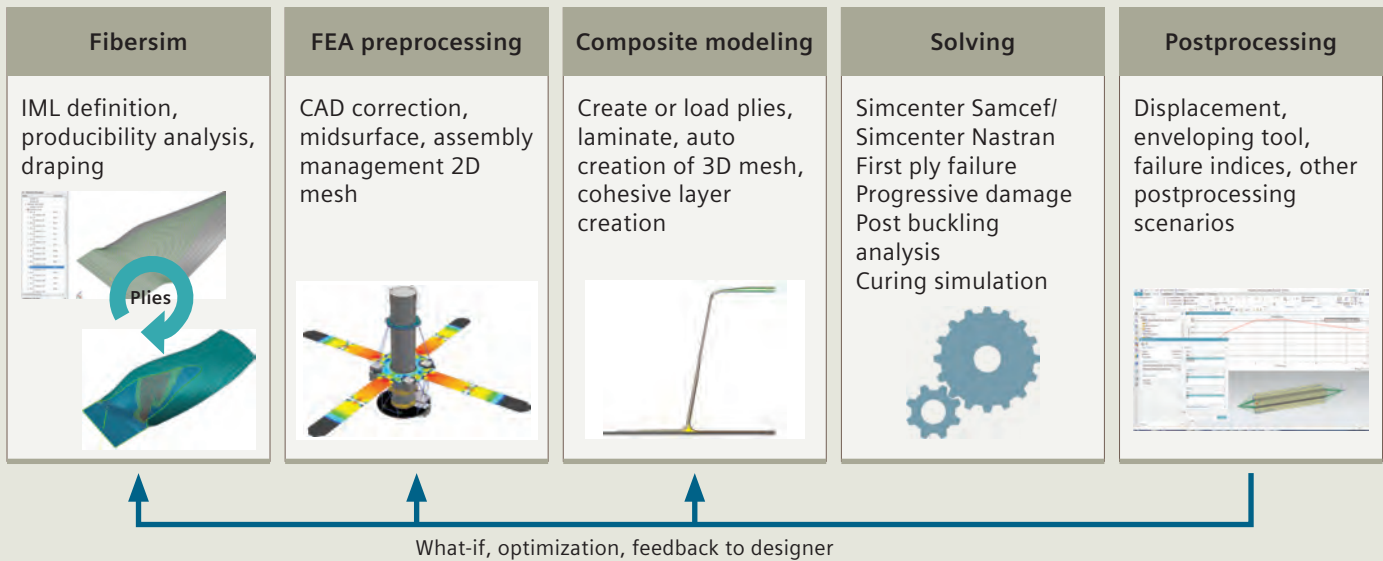

Short and long fiber reinforced composites CAE workflow.

Industry applications

Simcenter 3D composite simulation capabilities are used by many industries, although aerospace has always been a driver for this type of application thanks to its never-ending quest for reducing weight. These applications include:

Aerospace and defense

- Composites airplane frame – Stiffness, frame durability, nodal frequency
- Composite wings – Stiffness, skin buckling, modal frequency
- Satellite – Lightweight design
- Launch vehicles – Thermal stress, maneuver loads, payload bracket loads, lightweight design
- Aero engines fans – Rotating loads, distortion, composites
- Aero engines casing – Bearing loads, maneuver loads, lightweight design
- Manufacturing tools – Curing simulation
- Unmanned aerial vehicle (UAV) primary flight structures, tie rods, compression struts, high-altitude telescope structures, cooling tubes, shuttle actuator mounts and turbine fan blades

Automotive and transportation

- Body – Roof crush, panel strength, stiffness, frame durability, lightweight design
- Chassis – Harshness loads, suspension deflections
- Manufacturing tools – Curing simulation
- Drive shafts, suspension control arms, structural braces, crash structures and seat structures

Marine

- Ships, yacht, sport boats –Stiffness, deformation, strength, lightweight design
- Hulls – Skin rupture
- Bulkheads – Structural strength
- Boat hulls, decks and superstructures

Electronics

- Hand-held equipment made of composites – Drop simulation, plastic component stress

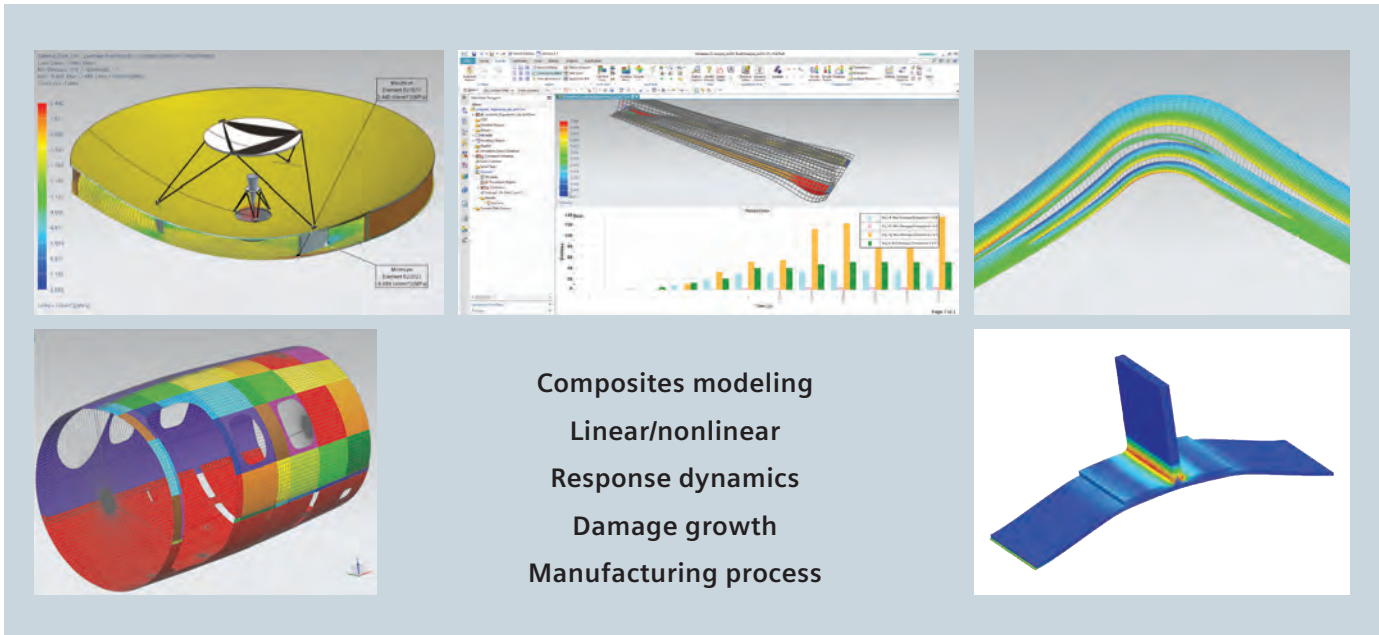

Simcenter 3D Laminate Composites

Easy-to-use ply and laminate definition tools in Simcenter 3D Laminate Composites enable you to quickly create finite element models of structures. Simcenter 3D Laminate Composites helps you create, optimize and validate composite structures using Simcenter Nastran® software, Simcenter Samcef, MSC Nastran, ANSYS, Abaqus or LS-DYNA as your solver. Laminate post reporting generates graphical and spreadsheet ply results from shell stress results and envelopes of ply stresses, strains and failure metrics on elements over multiple load cases.

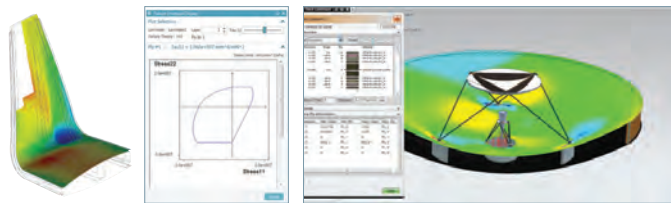

Module benefits

- Reduce laminate model creation time by choosing between zone-based modeling, ply-based modeling or a mixture of both approaches
- Leverage the open solver architecture of Simcenter 3D to perform state-of-the-art dynamic, nonlinear, progressive failure and delamination simulations

Key features

- Keep your model up-to-date with the latest design using geometry associativity
- Interact with computer-aided design (CAD) based composites definitions from Fibersim, CATIA and others
- Use Simcenter standard materials, or create ply materials from the constituent fiber and matrix material properties, to simulate plies made of woven, unidirectional, randomly oriented short fibers and particulates and to represent cores
- Conveniently assign laminates and plies to your choice of geometry, meshes and/or elements
- Improve finite element modeling accuracy by accounting for distorted fiber orientations
- Postprocessing tools allow you to quickly identify critical plies and load cases using classical and user-defined failure theories and create reports

Simcenter Samcef

Simcenter Samcef is used as a solver to simulate components made of composite materials. It facilitates not only classical linear and nonlinear analysis, but can be used to predict defects, including intra- and interlaminar defects, as they grow. This includes delamination and complex scenarios in which both defect types grow together in a fully coupled way.

Curing of thermoset materials induces undesirable deformations that require iterations in the manufacturing process. By combining robust thermal and structural analysis technologies, Simcenter Samcef offers thermal, chemical and mechanical capabilities to predict the residual strain from the curing cycle. This allows you to optimize your process, comparing manufacturing options for the curing cycle and the design, and applying mold compensation techniques to minimize springback effects at demolding. It is then possible to simulate as-built composite component rather than as-designed.

Module benefits

- Achieve weight reduction targets and provide safe, durable structures
- Design as manufactured and for manufacturability
- Capture and identify the behavior of layered composite components, reducing safety concerns
- Identify and optimize unexpected deformation during the curing cycle

Key features

- Static/dynamic/thermal analysis of composite models including material and geometrical nonlinear behaviors
- Comprehensive finite element library for 2D shell or 3D solids, cohesive zone modeling
- Orthotropic, anisotropic, bilinear, accurate progressive damage prediction including intra- and interlaminar damage with coupling of the corresponding damage
- Failure indices, strength ratios, usual finite element outputs

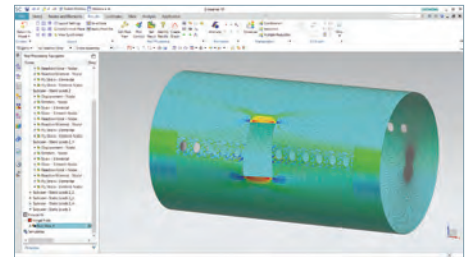
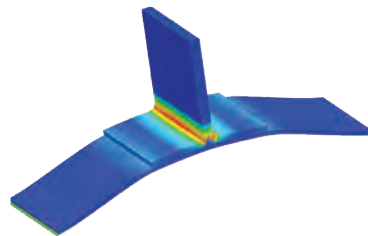
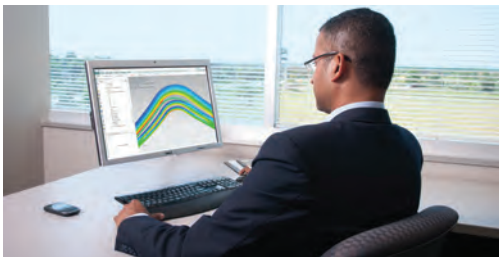

Capabilities chart

General capabilities	Specific capabilities	Simcenter 3D Laminate Composites	Simcenter Samcef solver
Composite types			
Unidirectional ply		•	•
Woven ply		•	•
Sandwich		•	•
Filament winding			◦
Fiber reinforced plastic			•
Analysis			
Linear statics with several load cases			•
Modal analysis			•
Buckling analysis (form linear statics analysis) with several load cases			•
Nonlinear static analysis with several subcases	Large displacement effect		•
	Large strain effect		•
Standalone bucking			•
Thermal analysis (steady state or transient)			•
Mapping of temperature field/glass temperature/degree of cure			•
Superelement generation, recovery on superelement			•
Cyclic symmetry recombination			•
Laminate modeling			
Laminate modeling and validation	Ply-based modeling	•	•
	Zone-based modeling	•	•
	2D laminates (layered shell)	•	•
	3D laminates (layered 3D solids) including automatic 3D inflation	•	•
	Automatic generation of cohesive layers	•	•
	Drop off element		•
	Anisotropic behavior of sheared woven plies	•	•
	ABDS matrices and equivalent properties	•	
	Fiber orientation displays	•	
	Ply section displays	•	
	View laminate core sampling	•	

General capabilities	Specific capabilities	Simcenter 3D Laminate Composites	Simcenter Samcef solver
CAD Interfaces	Fibersim	•	
	CATIA/laminate tools	•	
Postprocessing and reporting	Graphical and spreadsheet reporting	•	
	Enveloping by ply and load case	•	•
	Management of post reports and prerequisite solutions	•	
	Classical and user-defined failure theories	•	
	Multiple failure theories in single report	•	•
	Ply failure indices, strength ratios and margins of safety	•	•
	Dynamic base excitation metasolutions	•	
	Harmonic with phase-consistent failure metrics	•	
Random with confidence-based peak failure metrics	•		
Materials			
Isotropic			•
Temperature dependent			•
Orthotropic			•
Temperature dependent			•
Anisotropic			•
Temperature dependent			•
Hyperelastic	Moony-Rivlin		•
	Arruda-Boyce		◦
	Ogden		•
	Foam		•
	Hart-Smith		◦
	Alexander		◦
	Marlow		◦
	Test based		◦
	Mullins effect		•
	Viscoelastic effect		◦
Nonlinear elastic			•

General capabilities	Specific capabilities	Simcenter 3D Laminate Composites	Simcenter Samcef solver
Gasket			◦
Visco-elastic			•
Plasticity	Temperature dependence		•
	Bilinear		•
	Multilinear		•
	Rupture		•
	Isotropic hardening		•
	Kinematic hardening		•
	Mixed hardening		•
	Cyclic plasticity		•
Strain rate effect			◦
Creep	Bailey Norton model		•
	Strain hardening power model		•
	Norton model		◦
	Garafolo model		◦
	Temperature dependent		•
Visco-plastic			•
User defined			◦
Composite			
Shell elements (mono and multilayers)			•
Solid elements (mono and multilayers)			•
Failure indices			•
Strength ratios			•
Cohesive delamination			•
Progressive failure			•
Non-local laws			•
Curing simulation			•
Elements			
3D solids			•
2D solids	Axisymmetric		•
	Plane stress		•
	Plane strain		•
	Generalized plane strain		◦
Shell			•
Thickness output			•
Membrane			•
Solid shell			•

General capabilities	Specific capabilities	Simcenter 3D Laminate Composites	Simcenter Samcef solver
Beam			•
Nonlinear effects			•
Springs			•
Nonlinear force displacement			•
Rods			•
Rigid	Large rotation effect		•
	Stiff rigid (RBE2)		•
	Constraint rigid (RBE3)		•
U-P formulations			•
Potential fluid			◦
Add/remove			•
Algorithms			
Static solution (implicit)			•
Transient solution (implicit)			•
Thermomechanical co-simulation			◦
Modal			•
Complex modal			◦
Buckling			•
Multistep			•
Arc length			•
Auto-time stepping			•
Shared memory parallel (SMP)			•
Distributed memory parallel (DMP)			•
Superelements			•
Recovery including stresses			•
Cyclic symmetry modes			•
Multi-stage cyclic symmetry			•
Harmonic modes			◦
Restart			•

General capabilities	Specific capabilities	Simcenter 3D Laminate Composites	Simcenter Samcef solver
Connections			
Glue	Sliding glue		•
	Large displacement		•
Bolted joints	1D		•
	2D		•
	3D		•
	Bolt sequencing by steps		•
	Bolt force output		•
Multipoint constraint (MPC)			•
Contact	Coulomb friction		•
	Other friction models		•
	No separation contact		•
	Fluid pressure penetration contact		•
	Temperature dependence		•
	Separation distance output		•
	Slip/slide distance output		•
	Pressure output		•
	Change by steps		◦
	Node-to-face contact		•
	Node-to-node contact		•
	Kinematic joints		

General capabilities	Specific capabilities	Simcenter 3D Laminate Composites	Simcenter Samcef solver
Loads and boundary conditions			
Gravity			•
Force/ moment			•
Pressure			•
Distributed force			•
Temperature	3D (spatial variation)		•
	4D (spatial and temporal variation)		•
	Temperature loads from external file		•
Enforced motion			•
Initial stress/strain	Unbalanced		•
	Balanced		
Initial damage for composite			•
Restraints			•
Change by steps			•
Geometry imperfections			•

Legend:

- = supported in solver and environment
- = supported in solver but limited in environment

Note: Simcenter 3D Engineering Desktop is a minimum prerequisite for all Simcenter 3D products. Other dependency or prerequisites may apply for individual products.

SIEMENS

Ingenuity for life

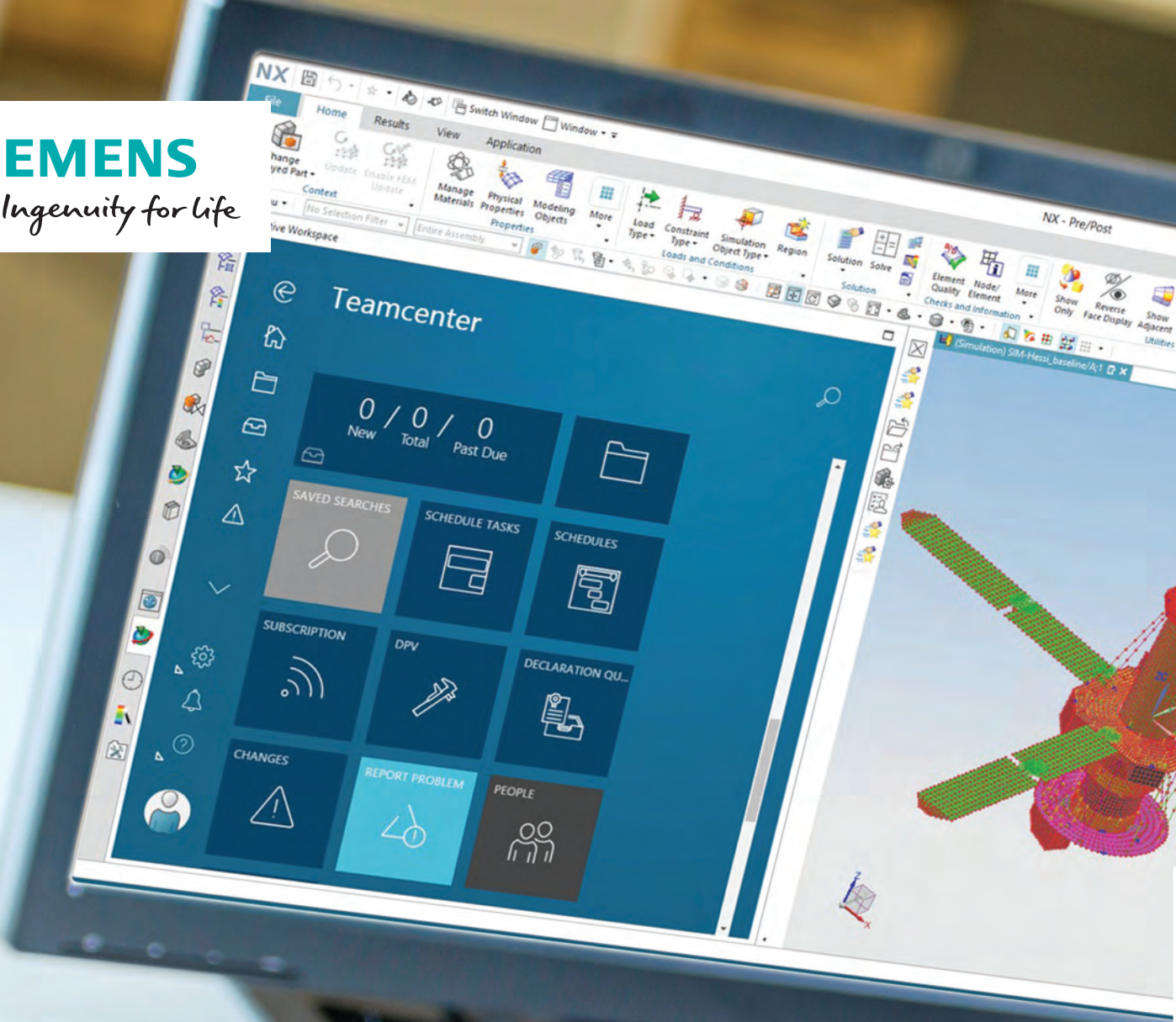

Siemens Digital Industries Software

Simcenter 3D in a managed environment

Providing full traceability of simulation work and data in a product development context

[siemens.com/simcenter3d](https://www.siemens.com/simcenter3d)



Solution benefits

- Deliver results faster by standardizing and automating simulation processes
- Support the increasing volume and complexity of simulation work by managing data and processes
- Reduce time to find data and enable greater re-use of work
- Increase confidence in your simulations with complete traceability from requirements through design and validation
- Provide visibility into the simulation process and results for program management and downstream operations
- Minimize implementation costs and risk by leveraging the proven Teamcenter platform as your common infrastructure solution

Simcenter™ 3D software can be used in a managed environment with Teamcenter® software for integration. When Simcenter 3D is used with Teamcenter integration, you can create, store and access your product simulation data in a Teamcenter database. It combines the power of Simcenter 3D in multiphysics modeling with the power of Teamcenter in storing and retrieving data in a controlled fashion.

In the Teamcenter solution for simulation process management data model, the idealized part file, the finite element method (FEM) file and the simulation file are stored as separate item revisions with defined relationships to the master part and to each other. This allows for full traceability of simulation work and data in the context of product development.

Simulation process management support

Simulation process management is a Teamcenter packaged software solution that enables you to track and manage finite element analysis (FEA) data.

Simcenter 3D in a managed environment

Using this data model and datasets, you can:

- Track item revisions for FEM and simulation files. When you create a new FEM or simulation, specify the number, name and revision
- Create an FEM and simulation on a locked master part
- Perform where-referenced queries on simulation data in Teamcenter. For example, you can find all simulations defined for a specific master part
- Create computer-aided engineering (CAE) data item revisions and edit their data relationships in the CAE manager in the Teamcenter client
- Create and manage CAE model structures in the CAE manager in the Teamcenter client and open those model structures in pre- and postprocessing as assembly FEMs

Providing end-to-end traceability and time savings

Data authored with Simcenter 3D can be seamlessly captured and managed with Teamcenter software for simulation process management. The out-of-the-box CAE data model is used to capture and manage idealized parts, finite element models, simulation files, input decks, results and reports. All Simcenter 3D data is stored in the database with relationship links, thus providing traceability from a product all the way to the associated simulation results. Using the powerful search capabilities, analysts can quickly find simulation data based on attributes and relationships, thus eliminating rework and overhead in organizing and finding data.

Leveraging structure management and automation

Assembly FEMs authored with Simcenter 3D can be managed in Teamcenter solutions for simulation process management along with complete traceability at the component, subassembly and assembly levels. Using automation capabilities, assembly FEMs can be automatically generated from a computer-aided design (CAD) assembly with automatic filtering of parts and re-use of any existing FEMs, which significantly speeds up the model build process.

Effectively managing large amounts of data

Selective download of solution files

A CAE solution dataset may contain multiple results files and other solver-related files in addition to the simulation file. These files can be large, so to improve download times you may prefer not to download them every time the simulation file from Teamcenter is opened.

Providing increased confidence and timely delivery of results

Simcenter 3D provides the ability to generate simulations and results with lightweight the JT™ data format representation. This enables analysts and other parties to visualize product data in Teamcenter without having to launch Simcenter 3D. This provides a framework from which CAE results and related reports can be communicated across the enterprise. Providing clearly traceable outcomes along with process efficiencies facilitates increased confidence and timely delivery of results.

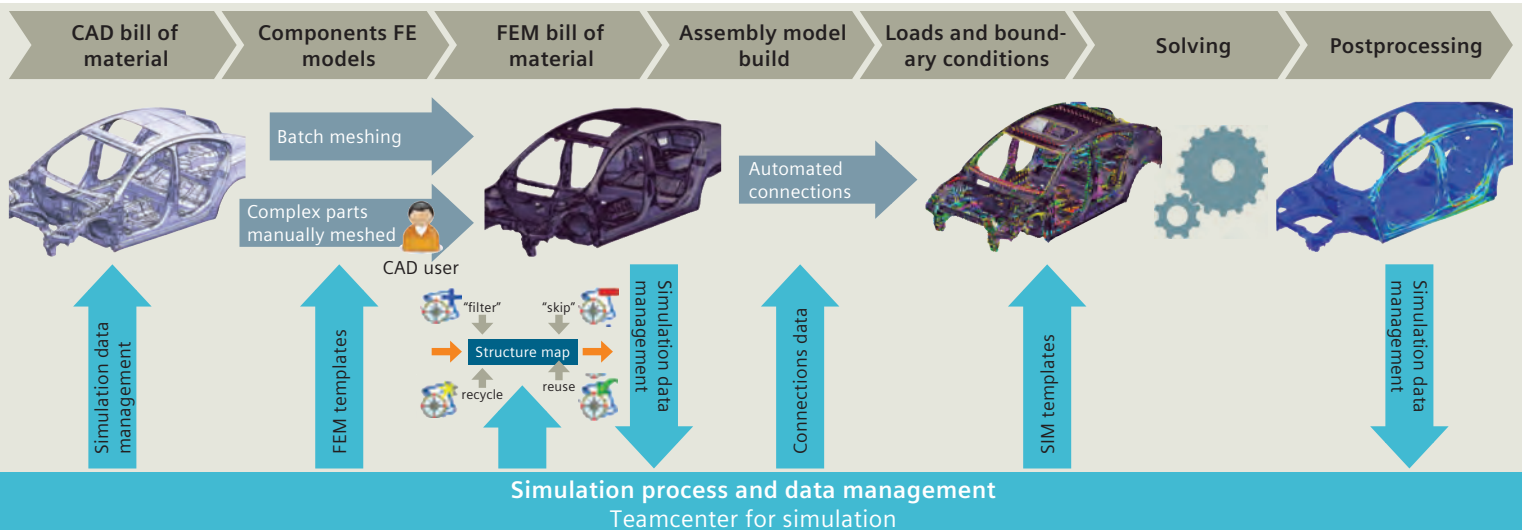

Industry applications

Efficiently manage industry-specific CAE simulation processes, data, workflow and share them with all decision-makers to better understand product performance and deliver highly successful products faster.

Automotive and transportation

Original equipment manufacturers (OEMs) and supplier engineering organizations need to handle simulation data for an increased number of product variations and configurations to be designed, engineered and manufactured around the globe. As an example, simulation data management enables engineering teams to manage the body-in-white (BIW) CAE model build process, automate solves and generate reports. You can also effectively manage knowledge transfer of core product development processes and methods across global sites. Benefits include increased re-use of models, traceability and quality through standardization.

Aerospace and defense

Aerospace companies work in globally distributed environments that necessitate efficient collaboration across teams, OEMs and suppliers. As an example, the aerostructure development process involves managing the integration of global and local models coming from different teams. Additionally, product development data needs to be securely stored for a long time. By capturing technical performance verification and providing continuous access to verified data, the simulation process and data management create a collaborative development environment, including suppliers and partners worldwide. Access to the latest and most accurate information has been demonstrated to

simplify processes, minimize post-design changes and rework and ensure deployment of best practices, which can boost program efficiency.

Marine

The marine industry also works with complex structures and can benefit from using simulation data and process management to ensure fast and secure implementation of product upgrades and modifications.

Industrial machinery and heavy equipment

Companies in agriculture, mining and other heavy equipment manufacturing as well the rotating machinery industry share many of the same needs as companies in the automotive and aerospace industries. As such, simulation data and process management are critical needs in these industries. Predicting performance using advanced multidisciplinary simulation techniques and managing requirements to ensure that all downstream design-manufacturing implications are considered during the early stages of product development requires an open product lifecycle management (PLM) system that is capable of handling CAE data from multiple tools.

Consumer goods

Sporting goods and toy companies want to deliver personalized products and highly customized design by adopting new methods and materials across the value chain. From design through manufacturing, access to the latest simulation data is paramount for fast moving consumer goods companies to develop the right product, on time the first time.

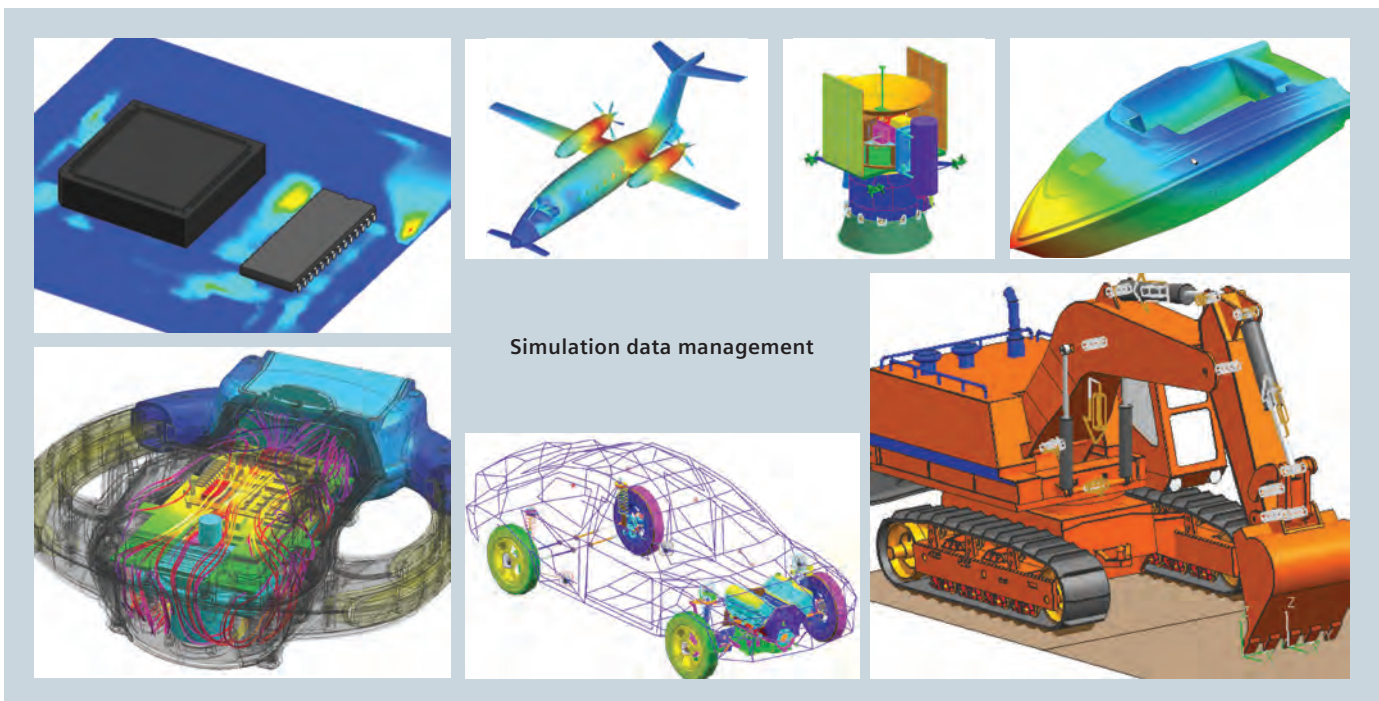

Embedded Client

Embedded Client provides global integrated synchronized management of all product and simulation data, comprehensive knowledge of the best process, for the complete aspects of product development from requirements through manufacturing.



Module benefits

- Manage and accelerate design/simulation collaboration for any size engineering team
- Provides seamless management, control and security for your design and simulation data
- Search rapidly for designs and simulations, manage data revisions, manage product configurations and changes to those product configurations in single or multi-site deployments.
- Access instantly live global product/simulation information
- Manage successfully your most precious asset – product and simulation knowledge

Key features

- Assembly Digital mock-up & multi-CAD
- Teamcenter Navigator:
 - Quick intuitive Teamcenter navigation and searches let you rapidly find the right data to load into the NX/Simcenter 3D session
 - Data for CAM, CAE, routing and mechatronics
- Embedded Active Workspace:
 - Extended access to PLM data: design datasheet, design BOM, where used, MS Office documents, classification, images, requirements
 - Cross-probing to NX navigators and graphics
 - Access to the inbox, submit to workflows

Simulation Author

This product provides a complete solution to manage simulation data, processes and tools (Simcenter 3D and others) in context with the product data. This product provides additional capabilities for managing Simcenter 3D data beyond what is included in Embedded Client software (refer to capabilities chart).

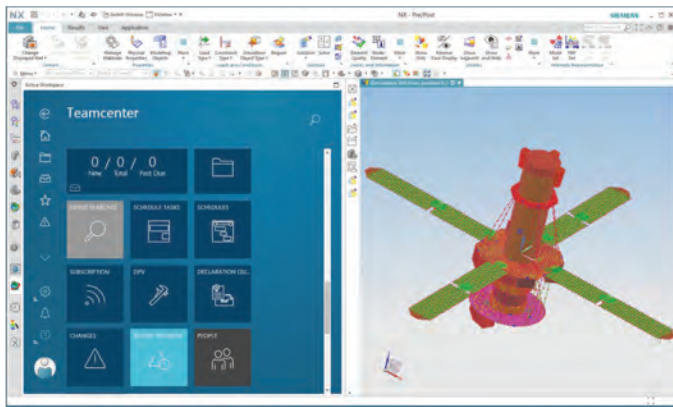

Module benefits

- Removes overhead of organizing and managing simulation data
- Provides end-to-end traceability of simulation data
- Eliminates rework through re-use of existing data
- Improves the efficiency of the model build process through automation and re-use
- Provides a collaborative environment in which simulation tasks can be distributed and executed
- Increases the confidence in the simulation results

Key features

- Simulation data and lifecycle management
- Simulation structure management and automation
- Simulation tool and process management
- Simulation results visualization and reporting

Capabilities chart

General capabilities	Specific capabilities	Embedded Client	Simulation Author
Simulation data and lifecycle management	Perform lifecycle operations (create, revise, update, delete etc.) of CAE data from Simcenter 3D GUI	•	•
	Perform lifecycle operations (create, revise, update, delete etc.) of CAE data from Teamcenter GUI		•
	Access to CAE manager application for navigation of CAE data		•
	Access to and management of key performance indicator (KPI) table		•
	Out of date model and out of date analysis detection in Teamcenter		•
	Recipe based creation of multiple CAE objects through CAE packages		•
	Monitor status of models and analysis (attributes, files, and variants) through simulation Dashboards		•
Simulation structure management and automation	Manual creation of AFEMs from Simcenter 3D GUI and capture them in the database	•	•
	Manual creation of AFEMs from Teamcenter GUI		•
	Compare AFEM with CAD structure for changes and update (Inspector)		•
	Compare AFEMs (CAE BOM compare)		•
	Automatic generation of AFEMs from CAD structure with reuse of models (through structure maps)		•
	Automated model creation through execution of Teamcenter workflows		•
Simulation tool and process management	Execute meshing and run solver on local machine through Simcenter 3D GUI	•	•
	Perform batch meshing from Teamcenter using Simcenter 3D on local, server or remote (HPC) machines		•
	Perform solver execution from Teamcenter on local, server or remote (HPC) machines		•
	Monitor the progress of jobs (batch meshing or solver)		•
Simulation results visualization and reporting	Access to CAE Manager application for JT visualization of CAE data		•
	Generate CAE JT files from Simcenter 3D GUI	•	•
	Generate CAE JT files from native result files in batch from Teamcenter through an NX Open utility		•

Legend:

- = included in module
- + = additional product required

Appendix

Simcenter 3D Engineering Desktop6	Simcenter 3D for electromagnetics simulation136	Multiple products: Coupling multiphysics simulation with flow and thermal problems 108
SC12500 Simcenter 3D Engineering Desktop 10	SC30710 Simcenter 3D Low Frequency EM 141	Multiple products: Coupled multiphysics simulation involving dynamics and acoustics 109
SC12500 Simcenter 3D Environment for Simcenter Nastran 11	SC30711 Simcenter MAGNET solver 142	SC30595 Simcenter 3D Aero-Vibro-Acoustics 110
SC30536 Simcenter 3D Environment for Simcenter Samcef 12	SC30712 Simcenter MAGNET Thermal solver 143	SC30712 Simcenter 3D Electromagnetics/Thermal 111
SC30551 Simcenter 3D Environment for Abaqus 13	SC30720 Simcenter 3D High Frequency EM 144	Simcenter 3D for optimization148
SC30550 Simcenter 3D Environment for ANSYS 14	SC30721 Simcenter High Frequency EM solver 145	NXN007 Simcenter Nastran Optimization 152
SC30523 Simcenter 3D Environment for LS-Dyna 15	Simcenter 3D for fluid dynamics simulation126	NXN016 Simcenter Nastran Topology Optimization 153
SC30549 Simcenter 3D Environment for MSC Nastran 16	SC30560 Simcenter 3D Advanced Fluid Modeling 130	SC30610 Simcenter 3D Design Space Exploration 154
Simcenter 3D for acoustics simulation..60	SC30508 Simcenter 3D Flow 131	SC12500 Simcenter 3D Geometry Optimization 155
SC30620 Simcenter 3D Meshing for Acoustics 65	SC30516 Simcenter 3D Advanced Flow 132	Simcenter 3D for structural simulation..20
NXN015 Simcenter Nastran Advanced Acoustics 66	SC30537 Simcenter 3D Flow HPC 133	SC13500 Simcenter 3D Structures 24
SC30593 Simcenter 3D Acoustic Transfer Vector 67	Simcenter 3D for motion simulation76	NXN001 Simcenter Nastran 25
SC30595 Simcenter 3D Aero-Vibro-Acoustics 68	SC30571 Simcenter 3D Motion Modeling 81	NXN030 Simcenter Nastran Multistep Nonlinear 26
SC30570 Simcenter 3D Environment for BEM Acoustics 69	SC30572 Simcenter 3D Motion solver 82	NXN010 Simcenter Nastran DMP 27
SC30580 Simcenter 3D Acoustics BEM solver 70	SC30581 Simcenter 3D Motion Systems and Controls 83	Simcenter 3D for structural dynamics simulation30
SC30592 Simcenter 3D Acoustics Accelerated BEM solver 71	SC30582 Simcenter 3D Motion Flexible Body 84	SC30521 Simcenter 3D Response Dynamics 34
SC30598 Simcenter 3D Acoustics Time Domain BEM solver 72	SC30583 Simcenter 3D Motion Flexible Body Advanced 85	SC30596 Simcenter 3D Noise and Vibration Modeling 35
SC30594 Simcenter 3D Acoustics HPC 73	SC30585 Simcenter 3D Motion Standard Tire 86	SC30501 Simcenter 3D Load Identification 36
Simcenter 3D for additive manufacturing simulation158	SC30586 Simcenter 3D Motion CD Tire 87	SC30500 Simcenter 3D NVH Composer 37
SC40100 Simcenter 3D Additive Manufacturing 162	SC30587 Simcenter 3D Motion MF-Tyre 88	SC30527 Simcenter 3D FE Model Correlation 38
NX30188 Omnimesh for Simcenter 3D 163	SC30588 Simcenter 3D Motion MF-Swift Tyre 89	SC30528 Simcenter 3D FE Model Updating 39
Simcenter 3D for aerostructures166	SC30590 Simcenter 3D Motion Drivetrain 90	NXN004 Simcenter Nastran Dynamic Response 40
SC30601 Simcenter 3D Aerostructure Environment 170	SC30579 Simcenter 3D Motion TWR 91	NXN002 Simcenter Nastran Advanced Dynamics bundle 41
SC30602 Simcenter 3D Margin of Safety 171	SC30576 Simcenter 3D Motion Real-Time solver 92	NXN010 Simcenter Nastran DMP 42
Simcenter 3D for composites simulation174	SC40510 Simcenter 3D Flexible Pipe Standard Beam 93	NXN014 Simcenter Nastran Rotor Dynamics 43
SC30522 Simcenter 3D Laminate Composites 179	SC40570 Simcenter 3D Flexible Pipe Standard Shell 94	SCSRO0170 Simcenter Samcef Rotor 44
SCMEC0180 Simcenter Samcef 180	SC40520 Simcenter 3D Flexible Pipe Linear Dynamic 95	Simcenter 3D for thermal simulation..114
Simcenter 3D for durability simulation .48	SC40530 Simcenter 3D Flexible Pipe Nonlinear Dynamic 96	SC30507 Simcenter 3D Thermal 119
SC30530 Simcenter 3D Durability wizard 52	SC40540 Simcenter 3D Flexible Pipe Optimization 97	SC30515 Simcenter 3D Advanced Thermal 120
SC30531 Simcenter 3D Advanced Durability 53	SC40590 Simcenter 3D Flexible Electric Cables and Wire Harness option 98	SC30517 Simcenter 3D Space Systems Thermal 121
SC30532 Simcenter 3D Specialist Durability Modeling 54	Simcenter 3D for multiphysics simulation102	SC30519 Simcenter 3D Electronic Systems Cooling 122
SC30540 Simcenter 3D Specialist Durability solver 55	Multiple products: Making multiphysics simulation more effective and reliable 106	SC30537 Simcenter 3D Thermal HPC 123
SC30541 Simcenter 3D Specialist Durability Composite Fatigue 56	Multiple products: Coupling multiphysics simulation of mechanical and thermal problems 107	Simcenter 3D in a managed environment.....184
SC30533 Simcenter 3D Specialist Durability for Connections 57		TC30600 Embedded Client 188
		TC31301 Simulation Author 189

About Siemens Digital Industries Software

Siemens Digital Industries Software is driving transformation to enable a digital enterprise where engineering, manufacturing and electronics design meet tomorrow. Our solutions help companies of all sizes create and leverage digital twins that provide organizations with new insights, opportunities and levels of automation to drive innovation. For more information on Siemens Digital Industries Software products and services, visit [siemens.com/software](https://www.siemens.com/software) or follow us on [LinkedIn](#), [Twitter](#), [Facebook](#) and [Instagram](#). Siemens Digital Industries Software – Where today meets tomorrow.

For More Information, Contact:

Scott Thibault

ATA Engineering, Inc.

T. (256) 850-3856

M. (802) 296-1617

E-mail: scott.thibault@ata-e.com

Headquarters: +1 972 987 3000
Americas: +1 314 264 8499
Europe: +44 (0) 1276 413200
Asia-Pacific: +852 2230 3333

© 2020 Siemens. A list of relevant Siemens trademarks can be found [here](#).
Other trademarks belong to their respective owners.
81150-C7 4/20 H